



Sample Preparation Products General Catalog

1

Introduction

Contents	2
QC	3
InertSep Format Guide	4
Selection Overview	6
InertSep Sorbent Guide	8

InertSep

Polymer-Based SPE (Reversed Phase)	12
Polymer-Based SPE (Ion Exchange)	16
Polymer-Based SPE (Chelate)	24
Silica-Based SPE (Non-Polar)	26
Silica-Based SPE (Polar)	36
Silica-Based SPE (Ion Exchange)	45
Specialty SPE	54

2

Accessories for SPE

Vacuum Manifold	64
Reservoir and Adaptor	68
Tube	70
Gravity Flow Manifold	72
Other Accessories	75
Syringe Filter	76

3

Life Science

Filter Plate	78
Monolith Silica	80
MonoSpin	81
SPE Tip Columns for Trace Samples	85
Exosome	86
MonoSpin ProA, MonoSpin ProG, MonoSpin ProL	88
Phosphorylation Purification & Enrichment	90
Tip Columns for Enrichment of Phosphopeptides	93
Desalting and Enrichment Phosphopeptide/Fractionation Tips	94

4

Cat.No. Index

.....	96
-------	----

ISO Certification



GL Sciences Fukushima Factory and General Technical Center are ISO14001 - Compliant Facility

Product Ranges: Design & Development, manufacture, stocking and selling of instruments, parts, accessories, columns, packing materials, reagents relating to gas chromatography, liquid chromatography and cells for spectrometry.



GL Sciences Fukushima Factory and R&D Dept. are ISO9001 Compliant Facility

Product Ranges: Design & Development, manufacture, stocking and selling of instruments, parts, accessories, columns, packing materials, reagents relating to gas chromatography, liquid chromatography and cells for spectrometry.



General Technical Center



Fukushima Factory

Quality Control

Certificate of Analysis

InertSep™ C18 1g / 6mL

Serial No. 16L0000
Sorbent Lot.No. 6100000

Analysis of Silica Gel

	Specifications	Results
Particle Size	[µm] 45 - 60	52
Surface Area	[m ² /g] 400 - 550	474
Pore Diameter	[nm] 5.5 - 7.5	6.2
Pore Volume	[mL/g] 0.60 - 0.80	0.74
Metal Impurity [Fe] (ICP-AES)	[ppm] < 100	9

Analysis of InertSep C18

(Functional group : Octadecyl(trifunctional))
Carbon Content [%] 17.5 - 20.5 18.0

Contamination Test

Sorbent	GC/FID	Pass
Tube	GC/FID	Pass
Frit	GC/FID	Pass

Chromatogram

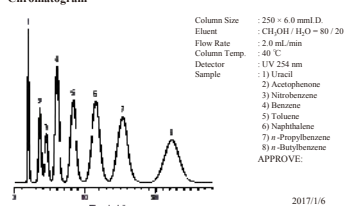

GL Sciences

22-1 Nishitetsuoka 6-chome, Shizuoka, Tokyo 163-1702, Japan
International Department TEL: +81-53523-6020 Fax: +81-53523-6021

Quality Control of InertSep Products

The InertSep series is an original GL Sciences brand produced in our own factory through development, manufacturing, quality control and inspection. Our Fukushima Manufacturing factory has obtained the International Organization for Standardization ISO-9001 certification. All solid-phase extraction products are manufactured under strict quality control and widely used in the analysis of food and water samples. All products are inspected and only those which pass our stringent criteria are shipped to customers. On request, we can provide a customization service and custom-made multi-sorbent beds in a cartridge.

InertSep Format Guide

96-well Plates Type

Cartridge volume : ① 1.2 mL ② 800 μ L
 Cartridge material : PP housing and PE frit

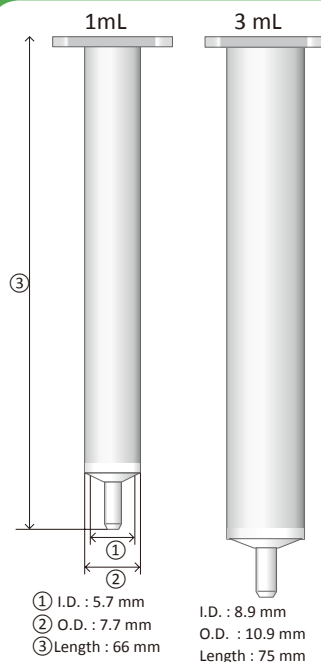
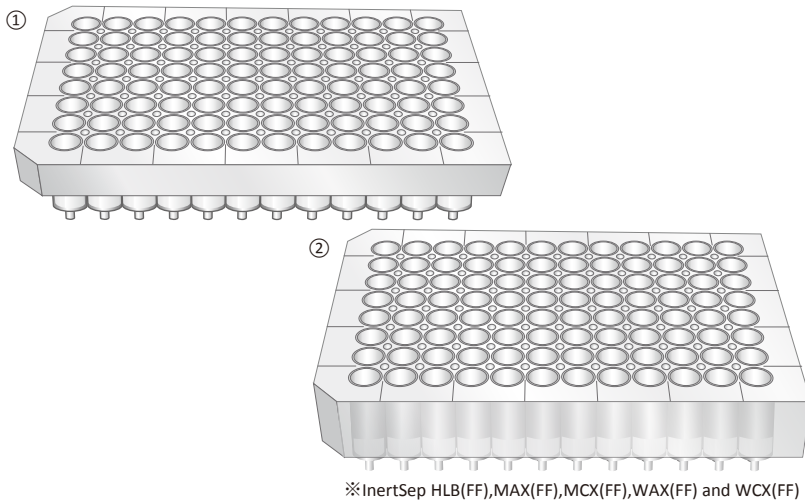

Luer Device Type

Dimensions : Slim: 8.8 ϕ , O.D. length 32 mm, 21 mm
 Slim-J: 8.8 ϕ , O.D. length 51 mm, 31 mm
 mini: 12.7 ϕ , O.D. length 12 mm
 Cartridge material: PP housing and PE frit

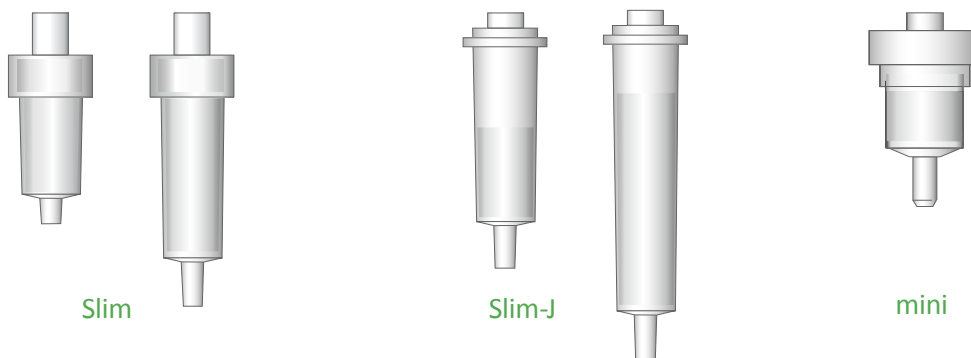

Spin Column Type

Cartridge volume: 1 mL
 Cartridge material: PP housing

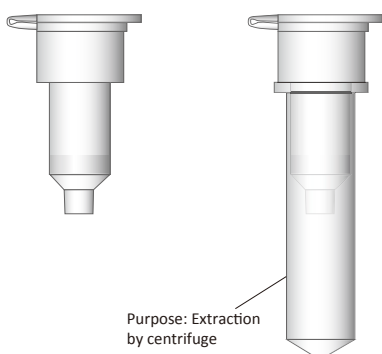

Tip Type

Cartridge volume: 10 μ L, 200 μ L
 Cartridge material: PP housing

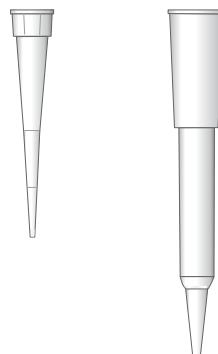

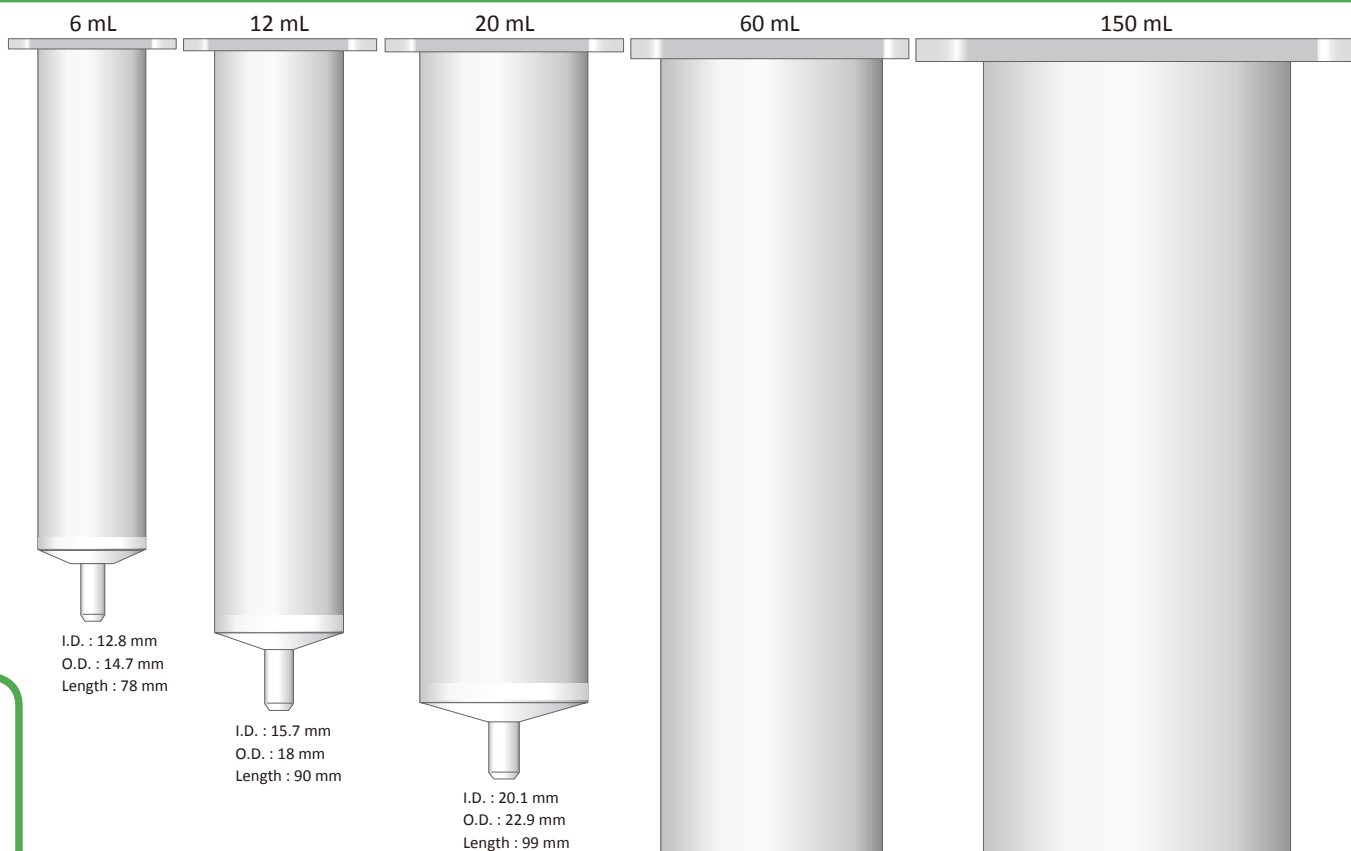

Syringe-Barrel Cartridges (Actual size)

Cartridge volume : 1, 3, 6, 12, 20, 60, 150 mL
Cartridge material : PP housing and PE frit

Large-size Cartridge (LSC)

Cartridge volume : 10 mL
Cartridge material : PP housing and PE frit

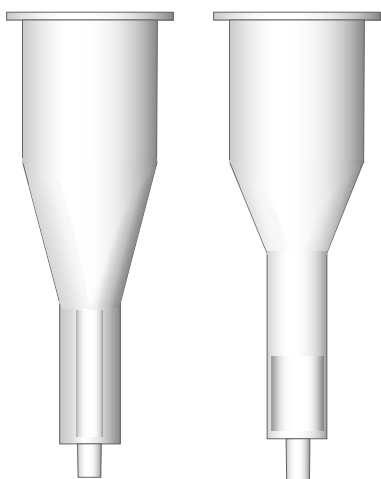

O.D. 6 mm for packed part of small SPE Bulk

O.D. 9 mm for packed part of SPE Bulk

EZ Cartridge

Dimensions : 25 mm
Cartridge material : PP housing

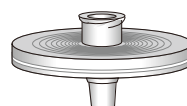

Objective of Solid Phase Extraction (SPE)

Separation and Purification of Target Analytes

The principle of SPE is divided into the following two methods.

① Retaining the target analyte

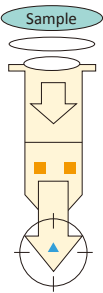

Mainly used to concentrate target analytes in aqueous sample matrix.

② Retaining the sample matrix and letting the target analytes pass through

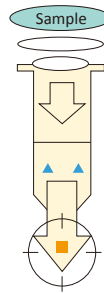

Used in simplification of complex sample matrix such as pesticide residues in crops and organic compounds in soil.

■ Target analyte
▲ Sample matrix

General Four Steps

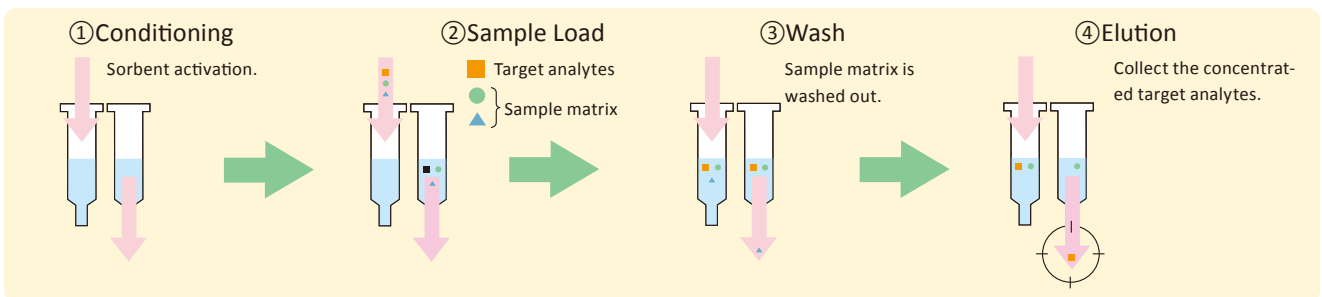

General Methods for Processing Sample

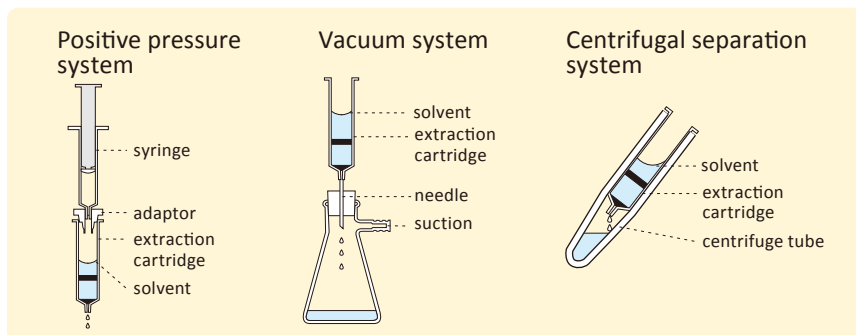

How to Select a Sorbent

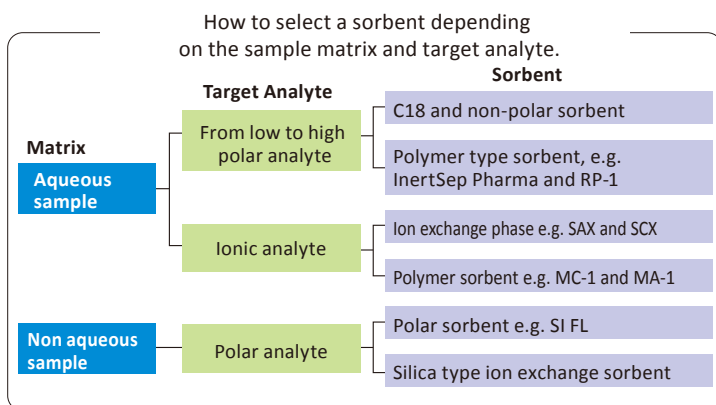

One of the most important elements to achieve successful of solid phase extraction is the selection of a sorbent suitable for both the sample matrix and the target analyte.

The sorbent should be carefully selected by taking into account the chemical and physical properties of both the target analyte and the sample matrix. In addition, it is important to develop conditions that are optimal for retaining the target analyte, while removing the sample matrix, then selecting an elution solvent for maximum recovery of the target analyte.

Retentive Capacity of a Sorbent Compared to Sorbent Mass

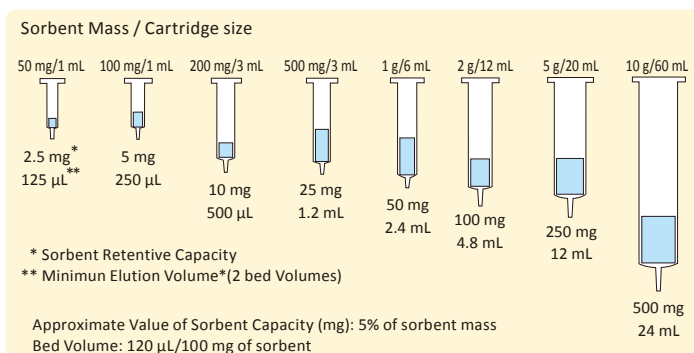

※Bed volume is the quantity of the solvent necessary to replace the air trapped in the solid phase. Void volume is equivalent to the bed volume

Recommendation for Selecting an Ion Exchange Sorbent

Target Analytes	InertSep	pKa*	Structure	Target Ion	
				Weak Ion	Strong Ion
Acidic	Anion Exchange	MA-1 4Class Amine	-CH ₂ -N ⁺ (R) ₃	✓	✗
		MA-2 2Class Amine	-CH ₂ -N (R) ₂	✓	✗
		NH ₂ Aminopropyl	-CH ₂ CH ₂ CH ₂ NH ₂	✗	✓
		PSA 1Class, 2Class Amine	-CH ₂ CH ₂ CH ₂ NHCH ₂ CH ₂ NH ₂	✗	✓
		SAX Tri-Methylaminopropyl	-CH ₂ CH ₂ CH ₂ N ⁺ (CH ₃) ₃	✓	✗
		SAX-2	-CH ₂ CH ₂ CH ₂ N ⁺ (CH ₃) ₃	✓	✗
Basic	Cation Exchange	MC-1 Sulfonic Acid	-CH ₂ -SO ₃ ⁻	✓	✗
		MC-2 Carboxylic Acid	-CH ₂ -COO ⁻	✓	✗
		CBA Ethyl Carboxylic Acid	-CH ₂ CH ₂ COO ⁻	✗	✓
		PRS Propyl Sulfonic Acid	-CH ₂ CH ₂ CH ₂ SO ₃ ⁻	✓	✗
		SCX Benzene Sulfonic Acid	-CH ₂ CH ₂ C ₆ H ₄ SO ₃ ⁻	✓	✗
		SCX-2	-CH ₂ CH ₂ C ₆ H ₄ SO ₃ ⁻	✓	✗

* pKa reference value for each functional group.

InertSep Sorbent Specifications

	InertSep	Page	Base Gel	Functional group	End-Capping
Polymer-Based SPE (Reversed Phase)	HLB	12	N-MA-SDB	-	-
	HLB FF	12		-	-
	PLS-2	13	SDB	-	-
	PLS-3	13	N-MA-SDB	-	-
	EZ Cartridge RP-1	14	MA-DVB	-	-
	Pharma	15	N-MA-SDB	-	-
Pharma FF	15	-		-	
Polymer-Based SPE (Ion Exchange)	MA-1	16	MA	Quaternary ammonium	-
	MA-2	17		Diethyl amine	-
	MC-1	18		Sulfonic acid	-
	MC-2	19		Carboxylic acid	-
	MAX	20	SDB	Quaternary ammonium	-
	MAX FF	20		Quaternary ammonium	-
	WAX	22		Diethyl amine	-
	WAX FF	22		Diethyl amine	-
	MCX	21		Sulfonic acid	-
	MCX FF	21		Sulfonic acid	-
	WCX	23		Carboxylic acid	-
	WCX FF	23		Carboxylic acid	-
Polymer-Based SPE (Chelate)	ME-1	24	MA	Iminodiacetic acid	-
	ME-2	25		Iminodiacetic acid + Tertiary amine	-
Silica-Based SPE (Non-Polar)	C18	26	SiO ₂	Octadecyl (trifunctional)	High
	C18 FF	27		Octadecyl (trifunctional)	High
	C18-B	28		Octadecyl (monofunctional)	Middle
	C18-C	29		Octadecyl (trifunctional)	Low
	C18-C FF	30		Octadecyl (trifunctional)	Low
	C18-ENV	31		Octadecyl (trifunctional)	Low
	C8	32		Octyl	Middle
	C2	33		Ethyl	Middle
	CH	34		Cyclohexyl	Middle
	PH	35		Phenyl	Middle
Silica-Based SPE (Polar)	CN	36	Aluminium oxide	Cyanopropyl	-
	2OH	37		Diol	-
	SI	38		-	-
	SI FF	39		-	-
	AL-A	40		-	-
	AL-N	41		-	-
	AL-B	42		-	-
	FL	43		Magnesium silicate (Florisil)	-
FL-PR	44	Magnesium silicate (Florisil PR)	-		
Silica-Based SPE (Ion Exchange)	CBA	45	SiO ₂	Propylcarboxylic acid	-
	PRS	46		Propylsulfonic acid	-
	SCX	47		Benzenesulfonic acid	-
	SCX-2	48		Benzenesulfonic acid	-
	NH2	49		AminoPropyl	-
	NH2 FF	50		AminoPropyl	-
	PSA	51		Ethylenediamine-N-propyl	-
	SAX	52		Quaternary ammonium	-
SAX-2	53	Quaternary ammonium	-		
Specialty Phases SPE	AC	54	Activated Carbon	-	-
	GC	54	Graphite Carbon	-	-
	DRY	57	Sodium sulfate, anhydrous (Na ₂ SO ₄)	-	-
	K-solute	58	Diatomaceous earth	-	-
	Phospholipid Remover	58	-	-	-

MA : Methacrylate polymer SDB : Styrene-Divinylbenzene copolymer DVB : Divinylbenzene copolymer

Average Particle Size (µm)	Surface Area (m ² /g)	Pore Size (nm)	Pore Volume (mL/g)	Carbon Load (%)	Ion exchange capacity (meq/g)	pH Range	Remark
30	720	7	1.3	-	-	1-14	
60	720	7	1.3	-	-	1-14	
70	700	7	1.1	-	-	1-14	
60	600	7	1.1	-	-	1-14	
10	-	-	-	-	-	1-14	
30	600	7	1.1	-	-	1-14	
60	600	7	1.1	-	-	1-14	
70	250	13	0.7	-	0.5	1-14	Cl ⁻ ion pair
70	250	13	0.8	-	0.5	1-14	Cl ⁻ ion pair
70	80	20	0.4	-	0.5	1-14	Na ⁺ ion pair
70	80	18	0.4	-	0.5	1-14	Na ⁺ ion pair
30	520	9	1.2	-	0.3	1-14	Cl ⁻ ion pair
70	480	9	1.1	-	0.3	1-14	Cl ⁻ ion pair
30	520	9	1.2	-	0.5	1-14	OH ⁻ ion pair
70	480	9	1.1	-	0.7	1-14	OH ⁻ ion pair
30	520	9	1.2	-	1.3	1-14	H ⁺ ion pair
70	480	9	1.1	-	1.2	1-14	H ⁺ ion pair
30	520	9	1.2	-	1.5	1-14	H ⁺ ion pair
70	480	9	1.1	-	1.2	1-14	H ⁺ ion pair
70	80	21	0.5	-	Cu ²⁺ 0.3 (mmol/g)	1-14	H ⁺ ion pair
70	80	21	0.5	-	Cu ²⁺ 0.3 (mmol/g)	1-14	H ⁺ ion pair
60	450	6	0.7	19	-	2-8	High Inertness
120	450	6	0.7	19	-	2-8	High Inertness
45	450	6	0.7	14	-	2-8	Normal Inertness
60	450	6	0.7	16	-	2-8	Poor Inertness
120	450	6	0.7	16	-	2-8	Poor Inertness
60	450	6	0.7	16	-	2-8	
60	450	6	0.7	12	-	2-8	
60	450	6	0.7	5.5	-	2-8	
60	450	6	0.7	7.5	-	2-8	
60	450	6	0.7	10	-	2-8	
45	450	6	0.7	7.5	-	2-8	
60	450	6	0.7	10	-	2-8	
60	450	6	0.7	-	-	2-8	
120	450	6	0.7	-	-	2-8	
100	130	8	0.3	-	-	-	acid(pH3.5-5.0)
100	130	8	0.3	-	-	-	neutral(pH6.0-7.5)
100	130	8	0.3	-	-	-	basic(pH9.0-10.5)
50-200	230	9	0.5	-	-	-	
100-300	230	9	0.5	-	-	-	
45	450	6	0.7	8.5	1.2	2-8	H ⁺ ion pair
45	450	6	0.7	8.5	1.2	2-8	H ⁺ ion pair
45	450	6	0.7	8.5	0.6	2-8	H ⁺ ion pair
60	450	6	0.7	17	1.2	2-8	Na ⁺ ion pair
60	450	6	0.7	10	0.9	2-8	
120	450	6	0.7	10	0.9	2-8	
60	450	6	0.7	11.5	1.5	2-8	
45	450	6	0.7	7	0.7	2-8	OH ⁻ ion pair
60	450	6	0.7	11.5	0.45	2-8	Cl ⁻ ion pair
60/150(mesh)	800-1200	-	-	-	-	-	
120/400(mesh)	85	45	1	-	-	-	
-	-	-	-	-	-	-	
10/42mesh > 90 %	-	-	-	-	-	-	
-	-	-	-	-	-	-	Phospholipid removal ratio > 90%



1. InertSep Series

● Polymer-Based SPE (Reversed Phase)	12
● Polymer-Based SPE (Ion Exchange)	16
● Polymer-Based SPE (Chelate)	24
● Silica-Based SPE (Non-Polar)	26
● Silica-Based SPE (Polar)	36
● Silica-Based SPE (Ion Exchange)	45
● Specialty SPE	54

Polymer-Based SPE (Reversed Phase)

1

InertSep Series

InertSep HLB

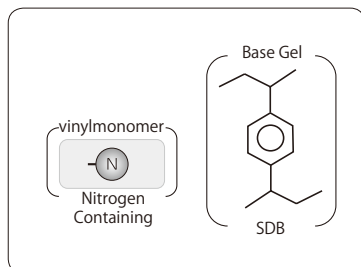

Average Particle Size : 30 μm
 Surface Area : 720 m^2/g
 Pore Volume : 1.3 mL/g
 Pore Size : 7 nm
 pH Range : 1-14

InertSep HLB is a reversed phase sorbent made of styrene-divinylbenzene (SDB) and a nitrogen-containing vinyl monomer.

Syringe-Barrel Cartridges

Description	Bed Weight/Volume	Qty.	Cat.No.
InertSep HLB	10 mg/1 mL	100 pcs	5010-27520
	30 mg/1 mL	100 pcs	5010-27521
	60 mg/3 mL	50 pcs	5010-27522
	150 mg/6 mL	30 pcs	5010-27525
	200 mg/6 mL	30 pcs	5010-27523
	500 mg/6 mL	30 pcs	5010-27524

Large-Size Cartridges(LSC)

Description	Bed Weight/Volume	Qty.	Cat.No.
InertSep LSC HLB	30 mg	50 pcs	5010-27625
	60 mg	50 pcs	5010-27626

96 Well Plate

Description	Bed Weight/Volume	Qty.	Cat.No.
InertSep 96WP HLB	5 mg	1 pc	5010-66442
	10 mg	1 pc	5010-66440
	30 mg	1 pc	5010-66441

Bulk Material

Description	Volume	Cat.No.
InertSep HLB	10 g	5010-69130
	100 g	5010-69131

InertSep HLB FF

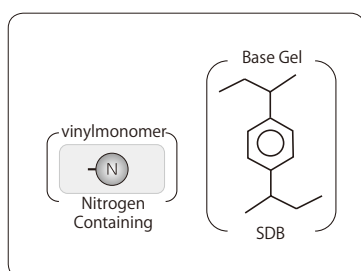

Average Particle Size : 60 μm
 Surface Area : 720 m^2/g
 Pore Volume : 1.3 mL/g
 Pore Size : 7 nm
 pH Range : 1-14

InertSep HLB FF is a high-flow version of InertSep HLB. Effective for rapid processing of highly viscous samples.

Syringe-Barrel Cartridges

Description	Bed Weight/Volume	Qty.	Cat.No.
InertSep HLB FF	60 mg/3 mL	50 pcs	5010-27532
	150 mg/6 mL	30 pcs	5010-27539
	200 mg/6 mL	30 pcs	5010-27533
	200 mg/20 mL	20 pcs	5010-27535
	400 mg/3 mL	100 pcs	5010-27537
	500 mg/6 mL	30 pcs	5010-27534
	500 mg/12 mL	20 pcs	5010-27540
	500 mg/20 mL	20 pcs	5010-27536
	540 mg/3 mL	100 pcs	5010-27538
	1 g/20 mL	20 pcs	5010-27541

96-Well Plates

Description	Bed Weight/Volume	Qty.	Cat.No.
InertSep 96WP HLB FF	60 mg	1 pc	5010-66450

Luer-Device Cartridges

Description	Bed Weight/Volume	Qty.	Cat.No.
InertSep Slim-J HLB FF	225 mg	50 pcs	5010-65795

Bulk Material

Description	Volume	Cat.No.
InertSep HLB FF	10 g	5010-69132
	100 g	5010-69133

Polymer-Based SPE (Reversed Phase)

1

InertSep Series

InertSep PLS-2

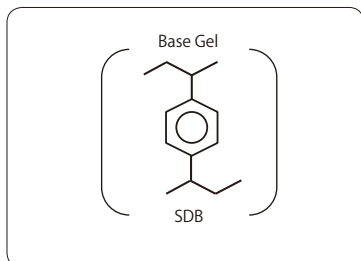

Average Particle Size : 70 µm
 Surface Area : 700 m²/g
 Pore Volume : 1.1 mL/g
 Pore Size : 7 nm
 pH Range : 1-14

InertSep PLS-2 is a SDB polymer-based reversed phase sorbent. Compared to silica based C18 sorbents, InertSep PLS-2 has a quite higher retention capacity and better stability in a wide pH range.

Syringe-Barrel Cartridges

Description	Bed Weight/Volume	Qty.(pk unit)	Cat.No.
InertSep PLS-2	265 mg/6 mL	50 pcs(25 pcs)	5010-27430
	265 mg/20 mL	20 pcs(10 pcs)	5010-27431
	270 mg/6 mL	50 pcs(5 pcs)	5010-25020
	500 mg/6 mL	30 pcs	5010-25025
	1 g/6 mL	20 pcs(5 pcs)	5010-25030
	270 mg/20 mL	20 pcs	5010-25035
	500 mg/20 mL	20 pcs(10 pcs)	5010-25036

Luer-Device Cartridges

Description	Bed Weight/Volume	Qty.	Cat.No.
InertSep Slim-J PLS-2	230 mg	50 pcs	5010-65720
	265 mg	50 pcs	5010-65721
InertSep Slim-J PLS-2 for AQUA*	265 mg	50 pcs	5010-65726

* InertSep PLS-2 was developed for water quality and environmental analysis.

Bulk Material

Description	Volume	Cat.No.
InertSep PLS-2	10 g	5010-69100
	100 g	5010-69101

InertSep PLS-3

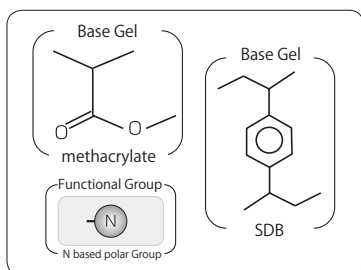

Average Particle Size : 60 µm
 Surface Area : 600 m²/g
 Pore Volume : 1.1 mL/g
 Pore Size : 7 nm
 pH Range : 1-14

InertSep PLS-3 is a copolymer-based sorbent comprised of nitrogen-containing methacrylate and SDB, exhibiting adequate retention for a variety of compounds from highly polar to hydrophobic compounds.

Syringe-Barrel Cartridges

Description	Bed Weight/Volume	Qty.(pk unit)	Cat.No.
InertSep PLS-3	200 mg/6 mL	30 pcs	5010-25050
	200 mg/20 mL	20 pcs(10 pcs)	5010-25051
InertSep Glass PLS-3	200 mg/6 mL	20 pcs	5010-26020

Luer-Device Cartridges

Description	Bed Weight/Volume	Qty.(pk unit)	Cat.No.
InertSep Slim-J PLS-3	230 mg	50 pcs	5010-25200
		500 pcs(50 pcs)	5010-25205
InertSep Slim-J PLS-3 for AQUA*	230 mg	50 pcs	5010-65775

* InertSep PLS-3 was developed for water quality and environmental analysis.

Bulk Material

Description	Volume	Cat.No.
InertSep PLS-3	10 g	5010-69102
	100 g	5010-69103

Polymer-Based SPE (Reversed Phase)

EZ Cartridge RP-1



EZ Cartridge RP-1 is a new type of cartridge that incorporates a 25 mm disc for use with pressurized pumping systems.

Description	Qty.	Cat.No.
EZ Cartridge RP-1	50 pcs	5010-30250

1

InertSep Series

Polymer-Based SPE (Reversed Phase)

InertSep Pharma

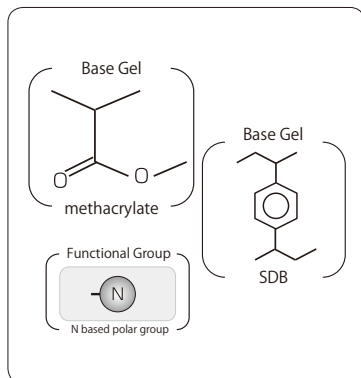

Average Particle Size : 30 μm
 Surface Area : 600 m^2/g
 Pore Volume : 1.1 mL/g
 Pore Size : 7 nm
 pH Range : 1-14

InertSep Pharma is a copolymer-based sorbent comprised of nitrogen-containing methacrylate and SDB. This sorbent was developed for simultaneous screening of drug metabolites in biological samples.

Syringe-Barrel Cartridges

Description	Bed Weight/Volume	Qty.	Cat.No.
InertSep Pharma	10 mg/1 mL	100 pcs	5010-27102
	30 mg/1 mL	100 pcs	5010-27100
	60 mg/3 mL	100 pcs	5010-27101
	200 mg/6 mL	30 pcs	5010-27103
	500 mg/6 mL	30 pcs	5010-27104
	500 mg/12 mL	20 pcs	5010-27105

Large-Size Cartridges (LSC)

Description	Bed Weight/Volume	Qty.(pk unit)	Cat.No.
InertSep LSC Pharma	30 mg	50 pcs(25 pcs)	5010-27621
	60 mg	50 pcs(25 pcs)	5010-27622
	200 mg	50 pcs(25 pcs)	5010-27623
	500 mg	50 pcs(25 pcs)	5010-27624

96-Well Plates

Description	Bed Weight/Volume	Qty.	Cat.No.
InertSep 96WP Pharma	30 mg	1 pc	5010-66230
	60 mg	1 pc	5010-66231

Bulk Material

Description	Volume	Cat.No.
InertSep Pharma	10 g	5010-69112
	100 g	5010-69113

InertSep Pharma FF

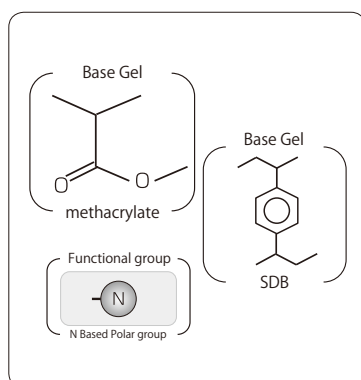

Average Particle Size : 60 μm
 Surface Area : 600 m^2/g
 Pore Volume : 1.1 mL/g
 Pore Size : 7 nm
 pH Range : 1-14

InertSep Pharma FF is a modified version of InertSep Pharma for high flow lates. This sorbent is suitable for viscous biological samples and large volume samples.

Syringe-Barrel Cartridges

Description	Bed Weight/Volume	Qty.	Cat.No.
InertSep Pharma FF	60 mg/3 mL	100 pcs	5010-27111
	200 mg/6 mL	30 pcs	5010-27113
	500 mg/6 mL	30 pcs	5010-27114

Large-Size Cartridges(LSC)

Description	Bed Weight/Volume	Qty.	Cat.No.
InertSep LSC Pharma FF	10 mg	500 pcs	5010-27620

Luer-Device Cartridges

Description	Bed Weight/Volume	Qty.	Cat.No.
InertSep Slim-J Pharma FF	230 mg	50 pcs	5010-65740

Bulk Material

Description	Volume	Cat.No.
InertSep Pharma FF	10 g	5010-69114
	100 g	5010-69115

Polymer-Based SPE (Ion Exchange)

1

InertSep Series

InertSep MA-1

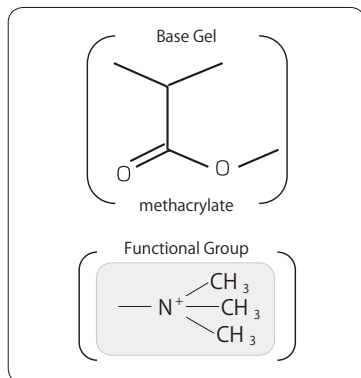

Average Particle Size : 70 μm
 Surface Area : 250 m^2/g
 Pore Volume : 0.7 mL/g
 Pore Size : 13 nm
 Ion exchange capacity : 0.5 meq/g
 pH Range : 1-14
 Remark : Cl^- ion pair

InertSep MA-1 is a methacrylate polymer-based sorbent modified with strong anion exchange functional groups. This sorbent is highly hydrophilic, and retained anions can be easily eluted.

Syringe-Barrel Cartridges

Description	Bed Weight/Volume	Qty.(pk unit)	Cat.No.
InertSep MA-1	10 mg/1 mL	100 pcs	5010-27303
	30 mg/1 mL	100 pcs(50 pcs)	5010-27304
	60 mg/3 mL	100 pcs(50 pcs)	5010-27305
	100 mg/3 mL	50 pcs(25 pcs)	5010-27300
	250 mg/6 mL	30 pcs	5010-27301
	500 mg/6 mL	30 pcs	5010-27302
	1 g/20 mL	20 pcs(10 pcs)	5010-27306
	2 g/20 mL	20 pcs(10 pcs)	5010-27307

Large-Size Cartridges (LSC)

Description	Bed Weight/Volume	Qty.(pk unit)	Cat.No.
InertSep LSC MA-1	10 mg	50 pcs(25 pcs)	5010-27630
	30 mg	50 pcs(25 pcs)	5010-27631
	60 mg	50 pcs(25 pcs)	5010-27632
	200 mg	50 pcs(25 pcs)	5010-27633
	500 mg	50 pcs(25 pcs)	5010-27634

Luer-Device Cartridges

Description	Bed Weight/Volume	Qty.	Cat.No.
InertSep mini MA-1	280 mg	50 pcs	5010-27205

96-Well Plates

Description	Bed Weight/Volume	Qty.	Cat.No.
InertSep 96WP MA-1	30 mg	1 pc	5010-66700
	60 mg	1 pc	5010-66701

Bulk Material

Description	Volume	Cat.No.
InertSep MA-1	10 g	5010-69116
	100 g	5010-69117

Polymer-Based SPE (Ion Exchange)

InertSep MA-2

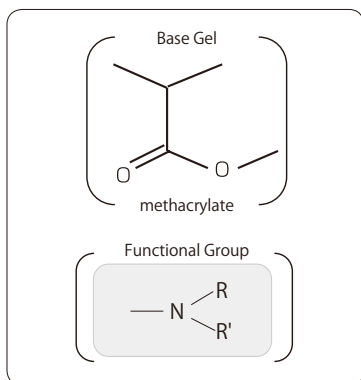

Average Particle Size	: 70 μm
Surface Area	: 250 m^2/g
Pore Volume	: 0.8 mL/g
Pore Size	: 13 nm
Ion exchange capacity	: 0.8 meq/g
pH Range	: 1-14
Remark	: Cl^- ion pair

InertSep MA-2 is a methacrylate polymer based sorbent modified with weak anion exchange groups. Suppressed secondary interactions of methacrylate polymer gel enables SPE solely by ion exchange.

Syringe-Barrel Cartridges

Description	Bed Weight/Volume	Qty.(pk unit)	Cat.No.
InertSep MA-2	10 mg/1 mL	100 pcs(50 pcs)	5010-27323
	30 mg/1 mL	100 pcs(50 pcs)	5010-27324
	60 mg/3 mL	100 pcs(50 pcs)	5010-27325
	100 mg/3 mL	50 pcs(25 pcs)	5010-27320
	150 mg/3 mL	50 pcs(25 pcs)	5010-27319
	150 mg/6 mL	50 pcs	5010-27331
	200 mg/6 mL	30 pcs	5010-27330
	250 mg/6 mL	30 pcs	5010-27321
	500 mg/6 mL	30 pcs	5010-27322
	1 g/20 mL	20 pcs(10 pcs)	5010-27326
2 g/20 mL	20 pcs(10 pcs)	5010-27327	

Large-Size Cartridges (LSC)

Description	Bed Weight/Volume	Qty.(pk unit)	Cat.No.
InertSep LSC MA-2	10 mg	50 pcs(25 pcs)	5010-27640
	30 mg	50 pcs(25 pcs)	5010-27641
	60 mg	50 pcs(25 pcs)	5010-27642
	150 mg	50 pcs(25 pcs)	5010-27645
	200 mg	50 pcs(25 pcs)	5010-27643
	500 mg	50 pcs(25 pcs)	5010-27644

Luer-Device Cartridges

Description	Bed Weight/Volume	Qty.	Cat.No.
InertSep mini MA-2	280 mg	50 pcs	5010-27235

96-Well Plates

Description	Bed Weight/Volume	Qty.	Cat.No.
InertSep 96WP MA-2	30 mg	1 pc	5010-66710
	60 mg	1 pc	5010-66711

Bulk Material

Description	Volume	Cat.No.
InertSep MA-2	10 g	5010-69118
	100 g	5010-69119

Polymer-Based SPE (Ion Exchange)

1

InertSep Series

InertSep MC-1

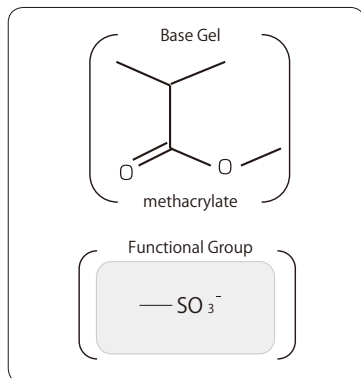

Average Particle Size : 70 μm
 Surface Area : 80 m^2/g
 Pore Volume : 0.4 mL/g
 Pore Size : 20 nm
 Ion exchange capacity : 0.5 meq/g
 pH Range : 1-14
 Remark : Na^+ ion pair

InertSep MC-1 is a methacrylate polymer based sorbent modified with strong cation exchange functional groups. This sorbent is highly hydrophilic, and retained cations can be easily eluted.

Syringe-Barrel Cartridges

Description	Bed Weight/Volume	Qty.(pk unit)	Cat.No.
InertSep MC-1	10 mg/1 mL	100 pcs(50 pcs)	5010-27353
	30 mg/1 mL	100 pcs(50 pcs)	5010-27354
	60 mg/3 mL	100 pcs(50 pcs)	5010-27355
	100 mg/3 mL	50 pcs(25 pcs)	5010-27350
	250 mg/6 mL	30 pcs	5010-27351
	500 mg/6 mL	30 pcs	5010-27352
	1 g/20 mL	20 pcs(10 pcs)	5010-27356
	2 g/20 mL	20 pcs(10 pcs)	5010-27357

Large-Size Cartridges (LSC)

Description	Bed Weight/Volume	Qty.(pk unit)	Cat.No.
InertSep LSC MC-1	10 mg	50 pcs(25 pcs)	5010-27650
	30 mg	50 pcs(25 pcs)	5010-27651
	60 mg	50 pcs(25 pcs)	5010-27652
	200 mg	50 pcs(25 pcs)	5010-27653
	500 mg	50 pcs(25 pcs)	5010-27654

Luer-Device Cartridges

Description	Bed Weight/Volume	Qty.	Cat.No.
InertSep mini MC-1	280 mg	50 pcs	5010-27210

96-Well Plates

Description	Bed Weight/Volume	Qty.	Cat.No.
InertSep 96WP MC-1	30 mg	1 pc	5010-66500
	60 mg	1 pc	5010-66501

Bulk Material

Description	Volume	Cat.No.
InertSep MC-1	10 g	5010-69120
	100 g	5010-69121

Polymer-Based SPE (Ion Exchange)

InertSep MC-2

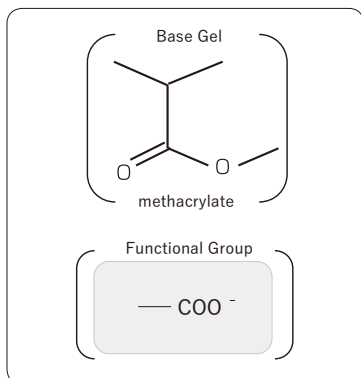

Average Particle Size : 70 μm
 Surface Area : 80 m²/g
 Pore Volume : 0.4 mL/g
 Pore Size : 18 nm
 Ion exchange capacity : 0.5 meq/g
 pH Range : 1-14
 Remark : Na⁺ ion pair

InertSep MC-2 is a methacrylate polymer based sorbent modified with weak cation exchange functional groups. This sorbent is suitable for SPE of strong anion compounds in ion exchange mode. Suppressed secondary interactions of methacrylate polymer gel enables SPE solely by ion exchange.

Syringe-Barrel Cartridges

Description	Bed Weight/Volume	Qty.(pk unit)	Cat.No.
InertSep MC-2	10 mg/1 mL	100 pcs(50 pcs)	5010-27373
	30 mg/1 mL	100 pcs(50 pcs)	5010-27374
	60 mg/3 mL	100 pcs(50 pcs)	5010-27375
	100 mg/3 mL	50 pcs(25 pcs)	5010-27370
	250 mg/6 mL	30 pcs	5010-27371
	500 mg/6 mL	30 pcs	5010-27372
	1 g/20 mL	20 pcs(10 pcs)	5010-27376
	2 g/20 mL	20 pcs(10 pcs)	5010-27377

Large-Size Cartridges (LSC)

Description	Bed Weight/Volume	Qty.(pk unit)	Cat.No.
InertSep LSC MC-2	10 mg	50 pcs(25 pcs)	5010-27660
	30 mg	50 pcs(25 pcs)	5010-27661
	60 mg	50 pcs(25 pcs)	5010-27662
	200 mg	50 pcs(25 pcs)	5010-27663
	500 mg	50 pcs(25 pcs)	5010-27664

Luer-Device Cartridges

Description	Bed Weight/Volume	Qty.	Cat.No.
InertSep mini MC-2	280 mg	50 pcs	5010-27240

96-Well Plates

Description	Bed Weight/Volume	Qty.	Cat.No.
InertSep 96WP MC-2	30 mg	1 pc	5010-66510
	60 mg	1 pc	5010-66511

Bulk Material

Description	Volume	Cat.No
InertSep MC-2	10 g	5010-69122
	100 g	5010-69123

Polymer-Based SPE (Ion Exchange)

1

InertSep Series

InertSep MAX Hydrophobic polymer modified by a strong anion-exchange groupe

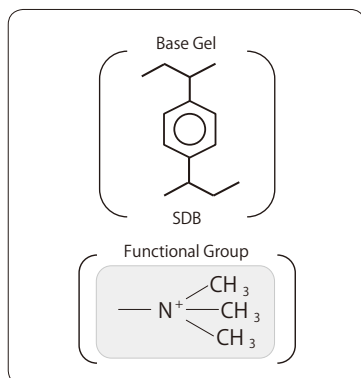

Average Particle Size : 30 μm
 Surface Area : 520 m^2/g
 Pore Volume : 1.2 mL/g
 Pore diameter : 9 nm
 pH Range : 1-14
 Ion exchange capacity : 0.3 meq/g

InertSep MAX is a mixed-mode SPE sorbent based on styrene divinylbenzene polymer modified by a strong anion-exchange group. It has a hydrophobic and an anion-exchange interaction, making it suitable for the pretreatment of weak acidic compounds.

Syringe-Barrel Cartridges

Description	Bed Weight/Volume	Qty.	Cat.No.
InertSep MAX	10 mg/1 mL	100 pcs	5010-62730
	30 mg/1 mL	100 pcs	5010-62731
	60 mg/3 mL	50 pcs	5010-62732
	150 mg/6 mL	30 pcs	5010-62733

Large-Size Cartridges(LSC)

Description	Bed Weight/Volume	Qty.	Cat.No.
InertSep LSC MAX	30 mg	50 pcs	5010-27565
	60 mg	50 pcs	5010-27566

96 Well Plates

Description	Bed Weight/Volume	Qty.	Cat.No.
InertSep 96WP MAX	10 mg	1 pc	5010-66480
	30 mg	1 pc	5010-66481
	60 mg	1 pc	5010-66482

InertSep MAX FF Hydrophobic polymer modified by a strong anion-exchange groupe

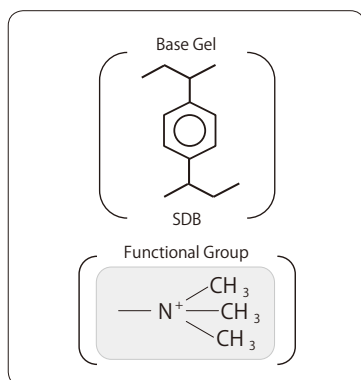

Average Particle Size : 70 μm
 Surface Area : 480 m^2/g
 Pore Volume : 1.1 mL/g
 Pore diameter : 9 nm
 Ion exchange capacity : 0.3 meq/g
 pH Range : 1-14
 Remark : Cl^- ion pair

InertSep MAX FF is a high-flow version of InertSep MAX. Effective for rapid processing of highly viscous samples.

Syringe-Barrel Cartridges

Description	Bed Weight/Volume	Qty.	Cat.No.
InertSep MAX FF	60 mg/3 mL	50 pcs	5010-62740
	150 mg/6 mL	100 pcs	5010-62741
	500 mg/6 mL	30 pcs	5010-62742
	150 mg/12 mL	20 pcs	5010-62743
	500 mg/20 mL	20 pcs	5010-62744

96-Well Plates

Description	Bed Weight/Volume	Qty.	Cat.No.
InertSep 96WP MAX FF	60 mg	1 pc	5010-66486

Luer-Device Cartridges

Description	Bed Weight/Volume	Qty.	Cat.No.
InertSep Slim-J MAX FF	225 mg	50 pcs	5010-65825

Large-Size Cartridges(LSC)

Description	Bed Weight/Volume	Qty.	Cat.No.
InertSep LSC MAX FF	60 mg	50 pcs	5010-27591

Bulk Material

Description	Volume	Cat.No.
InertSep MAX FF	10 g	5010-69138
	100 g	5010-69139

Polymer-Based SPE (Ion Exchange)

InertSep MCX Hydrophobic polymer modified by a strong cation-exchange group

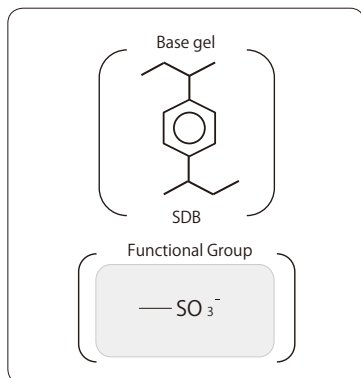

Average Particle Size	: 30 μm
Surface Area	: 520 m^2/g
Pore Volume	: 1.2 mL/g
Pore diameter	: 9 nm
pH Range	: 1-14
Ion exchange capacity	: 1.3 meq/g

InertSep MCX is a mixed-mode SPE sorbent based on styrene divinylbenzene polymer modified by a strong cation-exchange group. It has a hydrophobic and a cation-exchange interaction, making it suitable for the pretreatment of weak basic compounds.

Syringe-Barrel Cartridges

Description	Bed Weight/Volume	Qty.	Cat.No.
InertSep MCX	10 mg/1 mL	100 pcs	5010-62690
	30 mg/1 mL	100 pcs	5010-62691
	60 mg/3 mL	50 pcs	5010-62692
	150 mg/6 mL	30 pcs	5010-62693

Large-Size Cartridges(LSC)

Description	Bed Weight/Volume	Qty.	Cat.No.
InertSep LSC MCX	60 mg	50 pcs	5010-27556

96 Well Plates

Description	Bed Weight/Volume	Qty.	Cat.No.
InertSep 96WP MCX	10 mg	1 pc	5010-66460
	30 mg	1 pc	5010-66461
	60 mg	1 pc	5010-66462

InertSep MCX FF Hydrophobic polymer modified by a strong cation-exchange group

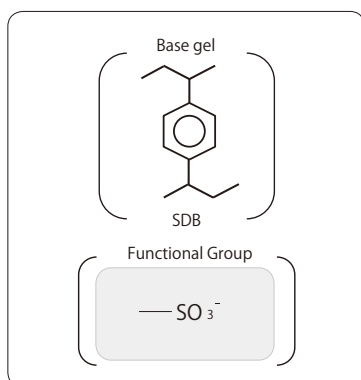

Average Particle Size	: 70 μm
Surface Area	: 480 m^2/g
Pore Volume	: 1.1 mL/g
Pore diameter	: 9 nm
Ion exchange capacity	: 1.2 meq/g
pH Range	: 1-14
Remark	: H^+ ion pair

InertSep MCX FF is a high-flow version of InertSep MCX. Effective for rapid processing of highly viscous samples.

Syringe-Barrel Cartridges

Description	Bed Weight/Volume	Qty.	Cat.No.
InertSep MCX FF	30 mg/1 mL	100 pcs	5010-62705
	60 mg/3 mL	50 pcs	5010-62700
	150 mg/6 mL	30 pcs	5010-62701
	500 mg/6 mL	30 pcs	5010-62702
	150 mg/12 mL	20 pcs	5010-62703
	500 mg/20 mL	20 pcs	5010-62704
	1 g/20 mL	20 pcs	5010-62706

96-Well Plates

Description	Bed Weight/Volume	Qty.	Cat.No.
InertSep 96WP MCX FF	30 mg	1 pc	5010-66465
	60 mg	1 pc	5010-66466

Luer-Device Cartridges

Description	Bed Weight/Volume	Qty.	Cat.No.
InertSep Slim-J MCX FF	225 mg	50 pcs	5010-65805

Large-Size Cartridges(LSC)

Description	Bed Weight/Volume	Qty.	Cat.No.
InertSep LSC MCX FF	60 mg	50 pcs	5010-27576

Bulk Material

Description	Volume	Cat.No.
InertSep MCX FF	10 g	5010-69134
	100 g	5010-69135

Polymer-Based SPE (Ion Exchange)

1

InertSep Series

InertSep WAX Hydrophobic polymer modified by a weak anion-exchange groupe

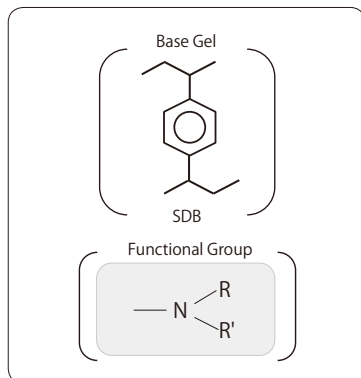

Average Particle Size : 30 μm
 Surface Area : 520 m^2/g
 Pore Volume : 1.2 mL/g
 Pore diameter : 9 nm
 pH Range : 1-14
 Ion exchange capacity : 0.5 meq/g

InertSep WAX is a mixed-mode SPE sorbent based on styrene divinylbenzene polymer modified by a weak anion-exchange group. It has a hydrophobic and an anion-exchange interaction, making it suitable for the pretreatment of strong acidic compounds.

Syringe-Barrel Cartridges

Description	Bed Weight/Volume	Qty.	Cat.No.
InertSep WAX	10 mg/1 mL	100 pcs	5010-62750
	30 mg/1 mL	100 pcs	5010-62751
	60 mg/3 mL	50 pcs	5010-62752
	150 mg/6 mL	30 pcs	5010-62753
	200 mg/6 mL	30 pcs	5010-62754
	500 mg/6 mL	30 pcs	5010-62755

96 Well Plates

Description	Bed Weight/Volume	Qty.	Cat.No.
InertSep 96WP WAX	10 mg	1 pc	5010-66490
	30 mg	1 pc	5010-66491
	60 mg	1 pc	5010-66492

InertSep WAX FF Hydrophobic polymer modified by a weak anion-exchange groupe

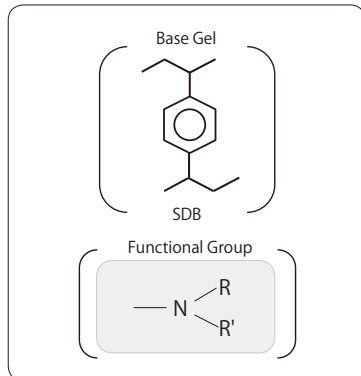

Average particle size : 70 μm
 Surface Area : 480 m^2/g
 Pore volume : 1.1 mL/g
 Pore diameter : 9 nm
 Ion exchange capacity : 0.7 meq/g
 pH Range : 1-14
 Remark : OH^- ion pair

InertSep WAX FF is a high-flow version of InertSep WAX. Effective for rapid processing of highly viscous samples.

Syringe-Barrel Cartridges

Description	Bed Weight/Volume	Qty.	Cat.No.
InertSep WAX FF	30 mg/1 mL	100 pcs	5010-62765
	60 mg/3 mL	50 pcs	5010-62760
	150 mg/6 mL	30 pcs	5010-62761
	500 mg/6 mL	30 pcs	5010-62762
	150 mg/12 mL	20 pcs	5010-62763
	500 mg/20 mL	20 pcs	5010-62764

Luer-Device Cartridges

Description	Bed Weight/Volume	Qty.	Cat.No.
InertSep Slim-J WAX FF	225 mg	50 pcs	5010-65835

Bulk Material

Description	Volume	Cat.No.
InertSep WAX FF	10 g	5010-69140
	100 g	5010-69141

Polymer-Based SPE (Ion Exchange)

1

InertSep Series

InertSep WCX Hydrophobic polymer modified by a weak cation-exchange group

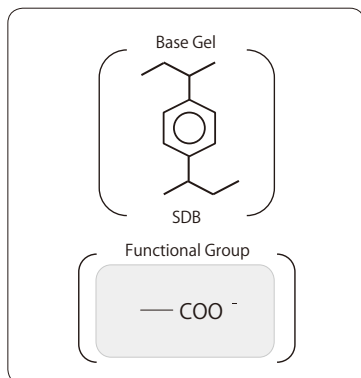

Average Particle Size : 30 μm
 Surface Area : 520 m^2/g
 Pore Volume : 1.2 mL/g
 Pore diameter : 9 nm
 pH Range : 1-14
 Ion exchange capacity : 1.5 meq/g

InertSep WCX is a mixed-mode SPE sorbent based on styrene divinylbenzene polymer modified by a weak cation-exchange group. It has a hydrophobic and a cation-exchange interaction, making it suitable for the pretreatment of strong basic compounds.

Syringe-Barrel Cartridges

Description	Bed Weight/Volume	Qty.	Cat.No.
InertSep WCX	10 mg/1 mL	100 pcs	5010-62710
	30 mg/1 mL	100 pcs	5010-62711
	60 mg/3 mL	50 pcs	5010-62712
	150 mg/6 mL	30 pcs	5010-62713

96 Well Plates

Description	Bed Weight/Volume	Qty.	Cat.No.
InertSep 96WP WCX	10 mg	1 pc	5010-66470
	30 mg	1 pc	5010-66471

InertSep WCX FF Hydrophobic polymer modified by a weak cation-exchange group

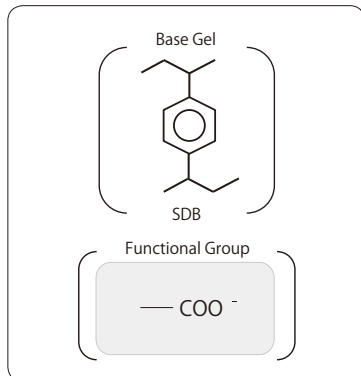

Average Particle Size : 70 μm
 Surface Area : 480 m^2/g
 Pore Volume : 1.1 mL/g
 Pore diameter : 9 nm
 Ion exchange capacity : 1.2 meq/g
 pH Range : 1-14
 Remark : H^+ ion pair

InertSep WCX FF is a high-flow version of InertSep WCX. Effective for rapid processing of highly viscous samples.

Syringe-Barrel Cartridges

Description	Bed Weight/Volume	Qty.	Cat.No.
InertSep WCX FF	30 mg/1 mL	100 pcs	5010-62725
	60 mg/3 mL	50 pcs	5010-62720
	150 mg/6 mL	30 pcs	5010-62721
	500 mg/6 mL	30 pcs	5010-62722
	150 mg/12 mL	20 pcs	5010-62723
	500 mg/20 mL	20 pcs	5010-62724

Luer-Device Cartridges

Description	Bed Weight/Volume	Qty.	Cat.No.
InertSep Slim-J WCX FF	225 mg	50 pcs	5010-65815

Bulk Material

Description	Volume	Cat.No.
InertSep WCX FF	10 g	5010-69136
	100 g	5010-69137

Polymer-Based SPE (Chelate)

InertSep ME-1

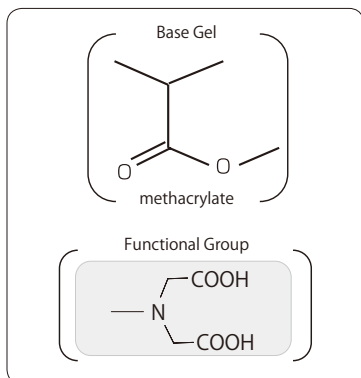

Average Particle Size : 70 μm
 Surface Area : 80 m^2/g
 Pore Volume : 0.5 mL/g
 Pore Size : 21 nm
 Ion exchange capacity : Cu^{2+} 0.3 mmol/g
 pH Range : 1-14
 Remark : H^+ ion pair

InertSep ME-1 is a methacrylate copolymer based solid sorbent modified with iminodiacetic acid, weak cation exchange functional groups. It is highly hydrophilic and does not retain monovalent Na ion or K ion, but it does retain metal divalent or more cations. This offers selective concentration of such metal ions and is suitable for custom made of Ni affinity plates for protein purification.

Syringe-Barrel Cartridges

Description	Bed Weight/Volume	Qty.(pk unit)	Cat.No.
InertSep ME-1	10 mg/1 mL	100 pcs(50 pcs)	5010-27403
	30 mg/1 mL	100 pcs(50 pcs)	5010-27404
	60 mg/3 mL	100 pcs(50 pcs)	5010-27405
	100 mg/3 mL	50 pcs(25 pcs)	5010-27400
	250 mg/6 mL	30 pcs	5010-27401
	500 mg/6 mL	30 pcs	5010-27402
	1 g/20 mL	20 pcs(10 pcs)	5010-27406
	2 g/20 mL	20 pcs(10 pcs)	5010-27407

Large-Size Cartridges (LSC)

Description	Bed Weight/Volume	Qty.(pk unit)	Cat.No.
InertSep LSC ME-1	10 mg	50 pcs(25 pcs)	5010-27670
	30 mg	50 pcs(25 pcs)	5010-27671
	60 mg	50 pcs(25 pcs)	5010-27672
	200 mg	50 pcs(25 pcs)	5010-27673
	500 mg	50 pcs(25 pcs)	5010-27674

Luer-Device Cartridges

Description	Bed Weight/Volume	Qty.	Cat.No.
InertSep mini ME-1	280 mg	50 pcs	5010-27215

96-Well Plates

Description	Bed Weight/Volume	Qty.	Cat.No.
InertSep 96WP ME-1	30 mg	1 pc	5010-66800
	60 mg	1 pc	5010-66801

Bulk Material

Description	Volume	Cat.No.
InertSep ME-1	10 g	5010-69126
	100 g	5010-69127

Polymer-Based SPE (Chelate)

InertSep ME-2

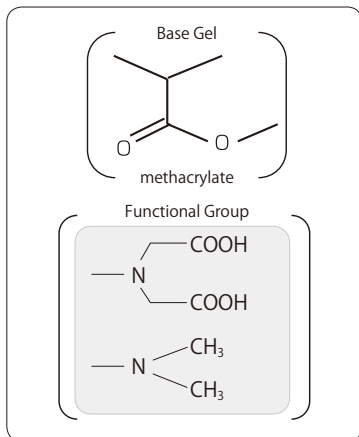

Average Particle Size : 70 μm
 Surface Area : 80 m^2/g
 Pore Volume : 0.5 mL/g
 Pore Size : 21 nm
 Ion exchange capacity : Cu^{2+} 0.3 mmol/g
 pH Range : 1-14
 Remark : H^+ ion pair

InertSep ME-2 is a chelating resin sorbent, developed for SPE of trace metal ions in seawater. As this sorbent does not retain Ca and Mg ions, desalting can be achieved by passing the sample through the sorbent and wash with purified water.

Syringe-Barrel Cartridges

Description	Bed Weight/Volume	Qty.(pk unit)	Cat.No.
InertSep ME-2	10 mg/1 mL	100 pcs(50 pcs)	5010-27413
	30 mg/1 mL	100 pcs(50 pcs)	5010-27414
	60 mg/3 mL	100 pcs(50 pcs)	5010-27415
	100 mg/3 mL	50 pcs(25 pcs)	5010-27410
	250 mg/6 mL	30 pcs	5010-27411
	500 mg/6 mL	30 pcs	5010-27412
	1 g/20 mL	20 pcs(10 pcs)	5010-27416
	2 g/20 mL	20 pcs(10 pcs)	5010-27417

Large-Size Cartridges (LSC)

Description	Bed Weight/Volume	Qty.(pk unit)	Cat.No.
InertSep LSC ME-2	30 mg	50 pcs(25 pcs)	5010-27681
	60 mg	50 pcs(25 pcs)	5010-27682
	200 mg	50 pcs(25 pcs)	5010-27683
	500 mg	50 pcs(25 pcs)	5010-27684

Luer-Device Cartridges

Description	Bed Weight/Volume	Qty.	Cat.No.
InertSep mini ME-2	280 mg	50 pcs	5010-27216

Bulk Material

Description	Volume	Cat.No.
InertSep ME-2	10 g	5010-69128
	100 g	5010-69129

Silica-Based SPE (Non-Polar)

1

InertSep Series

InertSep C18

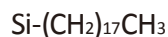

Average Particle Size : 60 μm
 Carbon Load : 19 %
 End-Capping : High
 Surface Area : 450 m^2/g
 Pore Volume : 0.7 mL/g
 Pore Size : 6 nm
 pH Range : 2-8

InertSep C18 is a silica-based sorbent modified with C18 for non-polar interactions. With our high-level end-capping technology, cation exchange by interaction with the residual silanol groups is suppressed, which reduces adsorption of basic compounds. This sorbent is suitable for removing lipid for simultaneous analysis of pesticide residues in agricultural products.

Syringe-Barrel Cartridges

Description	Bed Weight/Volume	Qty.(pk unit)	Cat.No.
InertSep C18	50 mg/1 mL	100 pcs	5010-61000
	100 mg/1 mL	100 pcs	5010-61001
	200 mg/1 mL	50 pcs	5010-61016
	200 mg/3 mL	50 pcs	5010-61002
	500 mg/3 mL	50 pcs	5010-61003
	500 mg/6 mL	30 pcs	5010-61004
	500 mg/20 mL	20 pcs(10 pcs)	5010-61013
	1 g/6 mL	30 pcs	5010-61005
	1 g/12 mL	20 pcs	5010-61015
	2 g/12 mL	20 pcs	5010-61006
	1 g/20 mL	20 pcs(10 pcs)	5010-61014
	5 g/20 mL	20 pcs(10 pcs)	5010-61007
	10 g/60 mL	16 pcs(4 pcs)	5010-61008
	20 g/60 mL	16 pcs(4 pcs)	5010-61009
	25 g/150 mL	8 pcs(1 pc)	5010-61010
	50 g/150 mL	8 pcs(1 pc)	5010-61011
70 g/150 mL	8 pcs(1 pc)	5010-61012	

Large-Size Cartridges (LSC)

Description	Bed Weight/Volume	Qty.(pk unit)	Cat.No.
InertSep LSC C18	100 mg	50 pcs(25 pcs)	5010-63001
	200 mg	50 pcs(25 pcs)	5010-63002
	500 mg	50 pcs(25 pcs)	5010-63003

Luer-Device Cartridges

Description	Bed Weight/Volume	Qty.	Cat.No.
InertSep Slim-J C18	500 mg	50 pcs	5010-65000
	1000 mg	50 pcs	5010-65001
InertSep Slim C18	400 mg	50 pcs	5010-65005
	900 mg	50 pcs	5010-65006

96-Well Plates

Description	Bed Weight/Volume	Qty.	Cat.No.
InertSep 96WP C18	50 mg	1 pc	5010-66000
	100 mg	1 pc	5010-66001

Bulk Material

Description	Volume	Cat.No.
InertSep C18	100 g	5010-69000

Silica-Based SPE (Non-Polar)

InertSep C18 FF

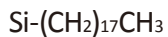

Average Particle Size : 120 μm
 Carbon Load : 19 %
 End-Capping : High
 Surface Area : 450 m²/g
 Pore Volume : 0.7 mL/g
 Pore Size : 6 nm
 pH Range : 2-8

InertSep C18 FF is a modified version of InertSep C18 for high flow lates. This sorbent is also suitable for viscous biological samples and large volume samples to increase the throughput.

Syringe-Barrel Cartridges

Description	Bed Weight/Volume	Qty.(pk unit)	Cat.No.
InertSep C18 FF	50 mg/1 mL	100 pcs	5010-62000
	100 mg/1 mL	100 pcs	5010-62001
	200 mg/3 mL	50 pcs	5010-62002
	500 mg/3 mL	50 pcs	5010-62003
	500 mg/6 mL	30 pcs	5010-62004
	1 g/6 mL	30 pcs	5010-62005
	2 g/12 mL	20 pcs	5010-62006
	5 g/20 mL	20 pcs(10 pcs)	5010-62007
	10 g/60 mL	16 pcs(4 pcs)	5010-62008
	20 g/60 mL	16 pcs(4 pcs)	5010-62009
	25 g/150 mL	8 pcs(1 pc)	5010-62010
	50 g/150 mL	8 pcs(1 pc)	5010-62011
70 g/150 mL	8 pcs(1 pc)	5010-62012	

Large-Size Cartridges (LSC)

Description	Bed Weight/Volume	Qty.(pk unit)	Cat.No.
InertSep LSC C18 FF	100 mg	50 pcs(25 pcs)	5010-64001
	200 mg	50 pcs(25 pcs)	5010-64002
	500 mg	50 pcs(25 pcs)	5010-64003

96-Well Plates

Description	Bed Weight/Volume	Qty.	Cat.No.
InertSep 96WP C18 FF	50 mg	1 pc	5010-66010
	100 mg	1 pc	5010-66011

Bulk Material

Description	Volume	Cat.No.
InertSep C18 FF	100 g	5010-69024

Silica-Based SPE (Non-Polar)

InertSep C18-B

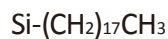

Average Particle Size : 45 μm
 Carbon Load : 14 %
 End-Capping : Middle
 Surface Area : 450 m²/g
 Pore Volume : 0.7 mL/g
 Pore Size : 6 nm
 pH Range : 2-8

InertSep C18-B is a silica-based sorbent modified with monofunctional C18 groups for non-polar interactions. In addition to the interaction, secondary interaction can be expected.

Syringe-Barrel Cartridges

Description	Bed Weight/Volume	Qty.(pk unit)	Cat.No.
InertSep C18-B	50 mg/1 mL	100 pcs	5010-61020
	100 mg/1 mL	100 pcs	5010-61021
	200 mg/3 mL	50 pcs	5010-61022
	500 mg/3 mL	50 pcs	5010-61023
	500 mg/6 mL	30 pcs	5010-61024
	1 g/6 mL	30 pcs	5010-61025
	2 g/12 mL	20 pcs	5010-61026
	5 g/20 mL	20 pcs(10 pcs)	5010-61027
	10 g/60 mL	16 pcs(4 pcs)	5010-61028

Large-Size Cartridges (LSC)

Description	Bed Weight/Volume	Qty.(pk unit)	Cat.No.
InertSep LSC C18-B	100 mg	50 pcs(25 pcs)	5010-63021
	200 mg	50 pcs(25 pcs)	5010-63022
	500 mg	50 pcs(25 pcs)	5010-63023

Luer-Device Cartridges

Description	Bed Weight/Volume	Qty.	Cat.No.
InertSep Slim-J C18-B	500 mg	50 pcs	5010-65020
	1000 mg	50 pcs	5010-65021
InertSep Slim C18-B	360 mg	50 pcs	5010-65025
	840 mg	50 pcs	5010-65026

96-Well Plates

Description	Bed Weight/Volume	Qty.	Cat.No.
InertSep 96WP C18-B	50 mg	1 pc	5010-66020
	100 mg	1 pc	5010-66021

Bulk Material

Description	Volume	Cat.No.
InertSep C18-B	100 g	5010-69001

Silica-Based SPE (Non-Polar)

InertSep C18-C

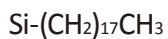

Average Particle Size	: 60 μm
Carbon Load	: 16 %
End-Capping	: Low
Surface Area	: 450 m^2/g
Pore Volume	: 0.7 mL/g
Pore Size	: 6 nm
pH Range	: 2-8

InertSep C18-C is a silica-based sorbent modified with trifunctional C18 groups for non-polar interactions. In addition to the non-polar interactions, secondary interaction between unbonded silanol groups on silica substrate and analytes can be expected.

Syringe-Barrel Cartridges

Description	Bed Weight/Volume	Qty.(pk unit)	Cat.No.
InertSep C18-C	50 mg/1 mL	100 pcs	5010-61040
	100 mg/1 mL	100 pcs	5010-61041
	200 mg/3 mL	50 pcs	5010-61042
	500 mg/3 mL	50 pcs	5010-61043
	500 mg/6 mL	30 pcs	5010-61044
	1 g/6 mL	30 pcs	5010-61045
	2 g/12 mL	20 pcs	5010-61046
	5 g/20 mL	20 pcs(10 pcs)	5010-61047
	10 g/60 mL	16 pcs(4 pcs)	5010-61048
	20 g/60 mL	16 pcs(4 pcs)	5010-61049
	25 g/150 mL	8 pcs(1 pc)	5010-61050
	50 g/150 mL	8 pcs(1 pc)	5010-61051
	70 g/150 mL	8 pcs(1 pc)	5010-61052

Large-Size Cartridges (LSC)

Description	Bed Weight/Volume	Qty.(pk unit)	Cat.No.
InertSep LSC C18-C	100 mg	50 pcs(25 pcs)	5010-63041
	200 mg	50 pcs(25 pcs)	5010-63042
	500 mg	50 pcs(25 pcs)	5010-63043

Luer-Device Cartridges

Description	Bed Weight/Volume	Qty.	Cat.No.
InertSep Slim-J C18-C	500 mg	50 pcs	5010-65040
	1000 mg	50 pcs	5010-65041
InertSep Slim C18-C	360 mg	50 pcs	5010-65045
	840 mg	50 pcs	5010-65046

96-Well Plates

Description	Bed Weight/Volume	Qty.	Cat.No.
InertSep 96WP C18-C	50 mg	1 pc	5010-66030
	100 mg	1 pc	5010-66031

Bulk Material

Description	Volume	Cat.No.
InertSep C18-C	100 g	5010-69002

Silica-Based SPE (Non-Polar)

InertSep C18-C FF

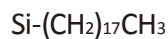

Average Particle Size : 120 μm
 Carbon Load : 16 %
 End-Capping : Low
 Surface Area : 450 m^2/g
 Pore Volume : 0.7 mL/g
 Pore Size : 6 nm
 pH Range : 2-8

InertSep C18-C FF is a modified version of InertSep C18-C for high flow rates. This sorbent is also suitable for viscous biological samples and large volume samples to increase the throughput.

Syringe-Barrel Cartridges

Description	Bed Weight/Volume	Qty.(pk unit)	Cat.No.
InertSep C18-C FF	50 mg/1 mL	100 pcs	5010-62040
	100 mg/1 mL	100 pcs	5010-62041
	200 mg/3 mL	50 pcs	5010-62042
	500 mg/3 mL	50 pcs	5010-62043
	500 mg/6 mL	30 pcs	5010-62044
	1 g/6 mL	30 pcs	5010-62045
	2 g/12 mL	20 pcs	5010-62046
	5 g/20 mL	20 pcs(10 pcs)	5010-62047
	10 g/60 mL	16 pcs(4 pcs)	5010-62048
	20 g/60 mL	16 pcs(4 pcs)	5010-62049
	25 g/150 mL	8 pcs(1 pc)	5010-62050
	50 g/150 mL	8 pcs(1 pc)	5010-62051
	70 g/150 mL	8 pcs(1 pc)	5010-62052

Large-Size Cartridges (LSC)

Description	Bed Weight/Volume	Qty.(pk unit)	Cat.No.
InertSep LSC C18-C FF	100 mg	50 pcs(25 pcs)	5010-64041
	200 mg	50 pcs(25 pcs)	5010-64042
	500 mg	50 pcs(25 pcs)	5010-64043

96-Well Plates

Description	Bed Weight/Volume	Qty.	Cat.No.
InertSep 96WP C18-C FF	50 mg	1 pc	5010-66040
	100 mg	1 pc	5010-66041

Bulk Material

Description	Volume	Cat.No.
InertSep C18-C FF	100 g	5010-69026

Silica-Based SPE (Non-Polar)

InertSep C18-ENV

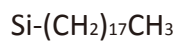

Average Particle Size	: 60 µm
Carbon Load	: 16 %
End-Capping	: Low
Surface Area	: 450 m ² /g
Pore Volume	: 0.7 mL/g
Pore Size	: 6 nm
pH Range	: 2-8

InertSep C18-ENV is a C18 solid phase synthesized for water quality analysis, and can be used for anionic surfactant pretreatment in water.

Syringe-Barrel Cartridges

Description	Bed Weight/Volume	Qty.	Cat.No.
InertSep C18-ENV	500 mg/6 mL	30 pcs	5010-61204

Luer-Device Cartridges

Description	Bed Weight/Volume	Qty.	Cat.No.
InertSep Slim-J C18-ENV	500 mg	50 pcs	5010-65200
	500 mg	500 pcs	5010-65205
	1000 mg	50 pcs	5010-65201

Silica-Based SPE (Non-Polar)

1

InertSep Series

InertSep C8

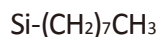

Average Particle Size : 60 μm
 Carbon Load : 12 %
 End-Capping : Middle
 Surface Area : 450 m²/g
 Pore Volume : 0.7 mL/g
 Pore Size : 6 nm
 pH Range : 2-8

InertSep C8 is a silica-based sorbent modified with C8 (octyl) function groups that offers a weaker non-polar interaction than C18. InertSep C8 is used for isolates that are strongly retained too much on C18. With high-level end-capping, cationic interaction with the silanol groups on silica substrate is virtually eliminated and adsorption of basic compounds is reduced.

Syringe-Barrel Cartridges

Description	Bed Weight/Volume	Qty.(pk unit)	Cat.No.
InertSep C8	50 mg/1 mL	100 pcs	5010-61080
	100 mg/1 mL	100 pcs	5010-61081
	200 mg/3 mL	50 pcs	5010-61082
	500 mg/3 mL	50 pcs	5010-61083
	500 mg/6 mL	30 pcs	5010-61084
	1 g/6 mL	30 pcs	5010-61085
	2 g/12 mL	20 pcs	5010-61086
	5 g/20 mL	20 pcs(10 pcs)	5010-61087
	10 g/60 mL	16 pcs(4 pcs)	5010-61088
	20 g/60 mL	16 pcs(4 pcs)	5010-61089
	25 g/150 mL	8 pcs(1 pc)	5010-61090
	50 g/150 mL	8 pcs(1 pc)	5010-61091
	70 g/150 mL	8 pcs(1 pc)	5010-61092

Large-Size Cartridges (LSC)

Description	Bed Weight/Volume	Qty.(pk unit)	Cat.No.
InertSep LSC C8	100 mg	50 pcs(25 pcs)	5010-63081
	200 mg	50 pcs(25 pcs)	5010-63082
	500 mg	50 pcs(25 pcs)	5010-63083

Luer-Device Cartridges

Description	Bed Weight/Volume	Qty.	Cat.No.
InertSep Slim-J C8	500 mg	50 pcs	5010-65080
	1000 mg	50 pcs	5010-65081

96-Well Plates

Description	Bed Weight/Volume	Qty.	Cat.No.
InertSep 96WP C8	50 mg	1 pc	5010-66050
	100 mg	1 pc	5010-66051

Bulk Material

Description	Volume	Cat.No.
InertSep C8	100 g	5010-69003

Silica-Based SPE (Non-Polar)

InertSep C2

Si-C₂H₅

Average Particle Size : 60 µm
 Carbon Load : 5.5 %
 End-Capping : Middle
 Surface Area : 450 m²/g
 Pore Volume : 0.7 mL/g
 Pore Size : 6 nm
 pH Range : 2-8

InertSep C2 is a silica-based sorbent modified with C2 (ethyl) functional groups being utilized for a weaker non-polar interaction than C8. InertSep C2 is used for isolates that are strongly retained too much on C8. As end-capping is accomplished on this sorbent, cation exchange interaction with none bonded silanol groups is virtually eliminated resulting in reduced adsorption of basic compounds.

Syringe-Barrel Cartridges

Description	Bed Weight/Volume	Qty.(pk unit)	Cat.No.
InertSep C2	50 mg/1 mL	100 pcs	5010-61120
	100 mg/1 mL	100 pcs	5010-61121
	200 mg/3 mL	50 pcs	5010-61122
	500 mg/3 mL	50 pcs	5010-61123
	500 mg/6 mL	30 pcs	5010-61124
	1 g/6 mL	30 pcs	5010-61125
	2 g/12 mL	20 pcs	5010-61126
	5 g/20 mL	20 pcs(10 pcs)	5010-61127
	10 g/60 mL	16 pcs(4 pcs)	5010-61128
	20 g/60 mL	16 pcs(4 pcs)	5010-61129
	25 g/150 mL	8 pcs(1 pc)	5010-61130
	50 g/150 mL	8 pcs(1 pc)	5010-61131
	70 g/150 mL	8 pcs(1 pc)	5010-61132

Large-Size Cartridges (LSC)

Description	Bed Weight/Volume	Qty.(pk unit)	Cat.No.
InertSep LSC C2	100 mg	50 pcs(25 pcs)	5010-63121
	200 mg	50 pcs(25 pcs)	5010-63122
	500 mg	50 pcs(25 pcs)	5010-63123

Luer-Device Cartridges

Description	Bed Weight/Volume	Qty.	Cat.No.
InertSep Slim-J C2	500 mg	50 pcs	5010-65120
	1000 mg	50 pcs	5010-65121

96-Well Plates

Description	Bed Weight/Volume	Qty.	Cat.No.
InertSep 96WP C2	50 mg	1 pc	5010-66070
	100 mg	1 pc	5010-66071

Bulk Material

Description	Volume	Cat.No.
InertSep C2	100 g	5010-69005

Silica-Based SPE (Non-Polar)

1

InertSep Series

InertSep CH

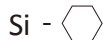

Average Particle Size : 60 µm
Carbon Load : 7.5 %
End-Capping : Middle
Surface Area : 450 m²/g
Pore Volume : 0.7 mL/g
Pore Size : 6 nm
pH Range : 2-8

InertSep CH is a silica-based sorbent modified with cyclohexyl functional groups that gives this sorbent a similar moderate polarity with InertSep C2. InertSep CH offers a unique selectivity for the extraction of certain chemical compounds, compared with C18, C8, C2 and PH.

Syringe-Barrel Cartridges

Description	Bed Weight/Volume	Qty.(pk unit)	Cat.No.
InertSep CH	50 mg/1 mL	100 pcs	5010-61160
	100 mg/1 mL	100 pcs	5010-61161
	200 mg/3 mL	50 pcs	5010-61162
	500 mg/3 mL	50 pcs	5010-61163
	500 mg/6 mL	30 pcs	5010-61164
	1 g/6 mL	30 pcs	5010-61165
	2 g/12 mL	20 pcs	5010-61166
	5 g/20 mL	20 pcs(10 pcs)	5010-61167
	10 g/60 mL	16 pcs(4 pcs)	5010-61168

Large-Size Cartridges (LSC)

Description	Bed Weight/Volume	Qty.(pk unit)	Cat.No.
InertSep LSC CH	100 mg	50 pcs(25 pcs)	5010-63161
	200 mg	50 pcs(25 pcs)	5010-63162
	500 mg	50 pcs(25 pcs)	5010-63163

Luer-Device Cartridges

Description	Bed Weight/Volume	Qty.	Cat.No.
InertSep Slim-J CH	500 mg	50 pcs	5010-65160
	1000 mg	50 pcs	5010-65161

96-Well Plates

Description	Bed Weight/Volume	Qty.	Cat.No.
InertSep 96WP CH	50 mg	1 pc	5010-66090
	100 mg	1 pc	5010-66091

Bulk Material

Description	Volume	Cat.No.
InertSep CH	100 g	5010-69007

Silica-Based SPE (Non-Polar)

InertSep PH

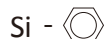

Average Particle Size	: 60 μm
Carbon Load	: 10 %
End-Capping	: Middle
Surface Area	: 450 m^2/g
Pore Volume	: 0.7 mL/g
Pore Size	: 6 nm
pH Range	: 2-8

InertSep PH is a silica-based sorbent modified with phenyl functional groups having a similar non-polar interaction to C8. Phenyl functional group has π - π bond interaction which allows an isolate molecule bearing benzene ring, such as aromatic compounds to selectively interact with phenyl functional group on the sorbent.

Syringe-Barrel Cartridges

Description	Bed Weight/Volume	Qty.(pk unit)	Cat.No.
InertSep PH	50 mg/1 mL	100 pcs	5010-61180
	100 mg/1 mL	100 pcs	5010-61181
	200 mg/3 mL	50 pcs	5010-61182
	500 mg/3 mL	50 pcs	5010-61183
	500 mg/6 mL	30 pcs	5010-61184
	1 g/6 mL	30 pcs	5010-61185
	2 g/12 mL	20 pcs	5010-61186
	5 g/20 mL	20 pcs(10 pcs)	5010-61187
	10 g/60 mL	16 pcs(4 pcs)	5010-61188
	20 g/60 mL	16 pcs(4 pcs)	5010-61189
	25 g/150 mL	8 pcs(1 pc)	5010-61190
	50 g/150 mL	8 pcs(1 pc)	5010-61191
	70 g/150 mL	8 pcs(1 pc)	5010-61192

Large-Size Cartridges (LSC)

Description	Bed Weight/Volume	Qty.(pk unit)	Cat.No.
InertSep LSC PH	100 mg	50 pcs(25 pcs)	5010-63181
	200 mg	50 pcs(25 pcs)	5010-63182
	500 mg	50 pcs(25 pcs)	5010-63183

Luer-Device Cartridges

Description	Bed Weight/Volume	Qty.	Cat.No.
InertSep Slim-J PH	500 mg	50 pcs	5010-65180
	1000 mg	50 pcs	5010-65181

96-Well Plates

Description	Bed Weight/Volume	Qty.	Cat.No.
InertSep 96WP PH	50 mg	1 pc	5010-66100
	100 mg	1 pc	5010-66101

Bulk Material

Description	Volume	Cat.No.
InertSep PH	100 g	5010-69008

Silica-Based SPE (Polar)

InertSep CN

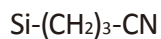

Average Particle Size : 45 μm
 Carbon Load : 7.5 %
 Surface Area : 450 m²/g
 Pore Volume : 0.7 mL/g
 Pore Size : 6 nm
 pH Range : 2-8

InertSep CN is a silica-based sorbent modified with cyanopropyl functional groups. Having both non-polar and polar interactions, InertSep CN is ideal for applications in which extremely non-polar isolates would irreversibly retain on more non-polar sorbents such as C18 or C8 and very polar isolates might be retained irreversibly on the most polar sorbents such as SI or 2OH.

Syringe-Barrel Cartridges

Description	Bed Weight/Volume	Qty.(pk unit)	Cat.No.
InertSep CN	50 mg/1 mL	100 pcs(5 pcs)	5010-61300
	100 mg/1 mL	100 pcs(5 pcs)	5010-61301
	200 mg/3 mL	50 pcs(5 pcs)	5010-61302
	500 mg/3 mL	50 pcs(1 pc)	5010-61303
	500 mg/6 mL	30 pcs(1 pc)	5010-61304
	1 g/6 mL	30 pcs(1 pc)	5010-61305
	2 g/12 mL	20 pcs(1 pc)	5010-61306
	5 g/20 mL	20 pcs(1 pc)	5010-61307
	10 g/60 mL	16 pcs(1 pc)	5010-61308

Large-Size Cartridges (LSC)

Description	Bed Weight/Volume	Qty.(pk unit)	Cat.No.
InertSep LSC CN	100 mg	50 pcs(1 pc)	5010-63301
	200 mg	50 pcs(1 pc)	5010-63302
	500 mg	50 pcs(1 pc)	5010-63303

Luer-Device Cartridges

Description	Bed Weight/Volume	Qty.(pk unit)	Cat.No.
InertSep Slim-J CN	500 mg	50 pcs(5 pcs)	5010-65300
	1000 mg	50 pcs(5 pcs)	5010-65301

96-Well Plates

Description	Bed Weight/Volume	Qty.	Cat.No.
InertSep 96WP CN	50 mg	1 pc	5010-66300
	100 mg	1 pc	5010-66301

Bulk Material

Description	Volume	Cat.No.
InertSep CN	100 g	5010-69009

Silica-Based SPE (Polar)

InertSep 2OH

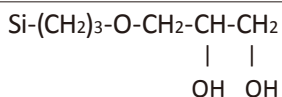

Average Particle Size : 60 μm
 Carbon Load : 10 %
 Surface Area : 450 m²/g
 Pore Volume : 0.7 mL/g
 Pore Size : 6 nm
 pH Range : 2-8

InertSep 2OH is a silica-based sorbent modified with diol functional groups. Being a fairly polar sorbent, InertSep 2OH is typically used for polar extractions from low-polar or non-polar solvents.

Syringe-Barrel Cartridges

Description	Bed Weight/Volume	Qty.(pk unit)	Cat.No.
InertSep 2OH	50 mg/1 mL	100 pcs(5 pcs)	5010-61320
	100 mg/1 mL	100 pcs(5 pcs)	5010-61321
	200 mg/3 mL	50 pcs(5 pcs)	5010-61322
	500 mg/3 mL	50 pcs(1 pc)	5010-61323
	500 mg/6 mL	30 pcs(1 pc)	5010-61324
	1 g/6 mL	30 pcs(1 pc)	5010-61325
	2 g/12 mL	20 pcs(1 pc)	5010-61326
	5 g/20 mL	20 pcs(1 pc)	5010-61327
	10 g/60 mL	16 pcs(1 pc)	5010-61328
	20 g/60 mL	16 pcs(1 pc)	5010-61329
	25 g/150 mL	8 pcs(1 pc)	5010-61330
	50 g/150 mL	8 pcs(1 pc)	5010-61331
	70 g/150 mL	8 pcs(1 pc)	5010-61332

Large-Size Cartridges (LSC)

Description	Bed Weight/Volume	Qty.(pk unit)	Cat.No.
InertSep LSC 2OH	100 mg	50 pcs(1 pc)	5010-63321
	200 mg	50 pcs(1 pc)	5010-63322
	500 mg	50 pcs(1 pc)	5010-63323

Luer-Device Cartridges

Description	Bed Weight/Volume	Qty.(pk unit)	Cat.No.
InertSep Slim-J 2OH	500 mg	50 pcs(5 pcs)	5010-65320
	1000 mg	50 pcs(5 pcs)	5010-65321
InertSep Slim 2OH	360 mg	50 pcs(5 pcs)	5010-65325

96-Well Plates

Description	Bed Weight/Volume	Qty.	Cat.No.
InertSep 96WP 2OH	50 mg	1 pc	5010-66310
	100 mg	1 pc	5010-66311

Bulk Material

Description	Volume	Cat.No.
InertSep 2OH	100 g	5010-69010

Silica-Based SPE (Polar)

1

InertSep Series

InertSep SI

Si-OH

Average Particle Size : 60 μm
 Surface Area : 450 m^2/g
 Pore Volume : 0.7 mL/g
 Pore Size : 6 nm
 pH Range : 2-8

InertSep SI is a bare silica, which has strong polar interaction. It offers selective separation for similar compounds in structure using low-polar solvents. InertSep SI is regarded as the most polar sorbent available. Care should be taken with humidity and polar solvents, when using this material.

Syringe-Barrel Cartridges

Description	Bed Weight/Volume	Qty.(pk unit)	Cat.No.
InertSep SI	50 mg/1 mL	100 pcs(5 pcs)	5010-61340
	100 mg/1 mL	100 pcs(5 pcs)	5010-61341
	200 mg/3 mL	50 pcs(5 pcs)	5010-61342
	500 mg/3 mL	50 pcs(1 pc)	5010-61343
	500 mg/6 mL	30 pcs(1 pc)	5010-61344
	1 g/6 mL	30 pcs(1 pc)	5010-61345
	2 g/12 mL	20 pcs(1 pc)	5010-61346
	5 g/20 mL	20 pcs(1 pc)	5010-61347
	10 g/60 mL	16 pcs(1 pc)	5010-61348
	20 g/60 mL	16 pcs(1 pc)	5010-61349
	25 g/150 mL	8 pcs(1 pc)	5010-61350
	50 g/150 mL	8 pcs(1 pc)	5010-61351
70 g/150 mL	8 pcs(1 pc)	5010-61352	

Large-Size Cartridges (LSC)

Description	Bed Weight/Volume	Qty.(pk unit)	Cat.No.
InertSep LSC SI	100 mg	50 pcs(1 pc)	5010-63341
	200 mg	50 pcs(1 pc)	5010-63342
	500 mg	50 pcs(1 pc)	5010-63343

Luer-Device Cartridges

Description	Bed Weight/Volume	Qty.(pk unit)	Cat.No.
InertSep Slim-J SI	500 mg	50 pcs(5 pcs)	5010-65340
	1000 mg	50 pcs(5 pcs)	5010-65341
InertSep Slim SI	690 mg	50 pcs(5 pcs)	5010-65345

96-Well Plates

Description	Bed Weight/Volume	Qty.	Cat.No.
InertSep 96WP SI	50 mg	1 pc	5010-66320
	100 mg	1 pc	5010-66321

Bulk Material

Description	Volume	Cat.No.
InertSep SI	100 g	5010-69011

Silica-Based SPE (Polar)

InertSep SI FF

Si-OH

Average Particle Size : 120 μ m
 Surface Area : 450 m²/g
 Pore Volume : 0.7 mL/g
 Pore Size : 6 nm
 pH Range : 2-8

InertSep SI FF is an arranged version of InertSep SI for applications that need high flow late. This sorbent is also good at viscous sample and large volume sample to expedite the procedure.

Syringe-Barrel Cartridges

Description	Bed Weight/Volume	Qty.(pk unit)	Cat.No.
InertSep SI FF	50 mg/1 mL	100 pcs(5 pcs)	5010-62340
	100 mg/1 mL	100 pcs(5 pcs)	5010-62341
	200 mg/3 mL	50 pcs(5 pcs)	5010-62342
	500 mg/3 mL	50 pcs(1 pc)	5010-62343
	500 mg/6 mL	30 pcs(1 pc)	5010-62344
	1 g/6 mL	30 pcs(1 pc)	5010-62345
	2 g/12 mL	20 pcs(1 pc)	5010-62346
	5 g/20 mL	20 pcs(1 pc)	5010-62347
	10 g/60 mL	16 pcs(1 pc)	5010-62348
	20 g/60 mL	16 pcs(1 pc)	5010-62349
	25 g/150 mL	8 pcs(1 pc)	5010-62350
	50 g/150 mL	8 pcs(1 pc)	5010-62351
70 g/150 mL	8 pcs(1 pc)	5010-62352	

Large-Size Cartridges (LSC)

Description	Bed Weight/Volume	Qty.(pk unit)	Cat.No.
InertSep LSC SI FF	100 mg	50 pcs(1 pc)	5010-64341
	200 mg	50 pcs(1 pc)	5010-64342
	500 mg	50 pcs(1 pc)	5010-64343

Bulk Material

Description	Volume	Cat.No.
InertSep SI FF	100 g	5010-69030

Silica-Based SPE (Polar)

InertSep AL-A

Al₂O₃

Average Particle Size : 100 μm
 Surface Area : 130 m²/g
 Pore Volume : 0.3 mL/g
 Pore Size : 8 nm
 pH Range : 3.5-5.0(acid)

InertSep AL-A is packed with alumina (Al₂O₃). Available in Al₂O₃ acidic format.

Syringe-Barrel Cartridges

Description	Bed Weight/Volume	Qty.(pk unit)	Cat.No.
InertSep AL-A	50 mg/1 mL	100 pcs(5 pcs)	5010-61360
	100 mg/1 mL	100 pcs(5 pcs)	5010-61361
	200 mg/3 mL	50 pcs(5 pcs)	5010-61362
	500 mg/3 mL	50 pcs(1 pc)	5010-61363
	500 mg/6 mL	30 pcs(1 pc)	5010-61364
	1 g/6 mL	30 pcs(1 pc)	5010-61365
	2 g/12 mL	20 pcs(1 pc)	5010-61366
	5 g/20 mL	20 pcs(1 pc)	5010-61367
	10 g/60 mL	16 pcs(1 pc)	5010-61368

Large-Size Cartridges (LSC)

Description	Bed Weight/Volume	Qty.(pk unit)	Cat.No.
InertSep LSC AL-A	100 mg	50 pcs(1 pc)	5010-63361
	200 mg	50 pcs(1 pc)	5010-63362
	500 mg	50 pcs(1 pc)	5010-63363

Luer-Device Cartridges

Description	Bed Weight/Volume	Qty.(pk unit)	Cat.No.
InertSep Slim-J AL-A	500 mg	50 pcs(5 pcs)	5010-65360
	1000 mg	50 pcs(5 pcs)	5010-65361
	1710 mg	50 pcs(5 pcs)	5010-65362

Bulk Material

Description	Volume	Cat.No.
InertSep AL-A	100 g	5010-69012

1

InertSep Series

Silica-Based SPE (Polar)

InertSep AL-N

Al₂O₃

Average Particle Size : 100 μm
 Surface Area : 130 m²/g
 Pore Volume : 0.3 mL/g
 Pore Size : 8 nm
 pH Range : 6.0-7.5 (neutral)

InertSep AL-N is packed with alumina (Al₂O₃). Available in Al₂O₃ neutral format.

Syringe-Barrel Cartridges

Description	Bed Weight/Volume	Qty.(pk unit)	Cat.No.
InertSep AL-N	50 mg/1 mL	100 pcs(5 pcs)	5010-61400
	100 mg/1 mL	100 pcs(5 pcs)	5010-61401
	200 mg/3 mL	50 pcs(5 pcs)	5010-61402
	500 mg/3 mL	50 pcs(1 pc)	5010-61403
	500 mg/6 mL	30 pcs(1 pc)	5010-61404
	1 g/6 mL	30 pcs(1 pc)	5010-61405
	2 g/12 mL	20 pcs(1 pc)	5010-61406
	5 g/20 mL	20 pcs(1 pc)	5010-61407
	10 g/60 mL	16 pcs(1 pc)	5010-61408

Large-Size Cartridges (LSC)

Description	Bed Weight/Volume	Qty.(pk unit)	Cat.No.
InertSep LSC AL-N	100 mg	50 pcs(1 pc)	5010-63401
	200 mg	50 pcs(1 pc)	5010-63402
	500 mg	50 pcs(1 pc)	5010-63403

Luer-Device Cartridges

Description	Bed Weight/Volume	Qty.(pk unit)	Cat.No.
InertSep Slim-J AL-N	500 mg	50 pcs(5 pcs)	5010-65400
	1000 mg	50 pcs(5 pcs)	5010-65401
	1710 mg	50 pcs(5 pcs)	5010-65402
	1850 mg	50 pcs(5 pcs)	5010-65403

Bulk Material

Description	Volume	Cat.No.
InertSep AL-N	100 g	5010-69014

Silica-Based SPE (Polar)

InertSep AL-B

Al₂O₃

Average Particle Size : 100 μm
 Surface Area : 130 m²/g
 Pore Volume : 0.3 mL/g
 Pore Size : 8 nm
 pH : 9.0-10.5(basic)

InertSep AL-B is packed with alumina (Al₂O₃). Available in Al₂O₃ basic format.

Syringe-Barrel Cartridges

Description	Bed Weight/Volume	Qty.(pk unit)	Cat.No.
InertSep AL-B	50 mg/1 mL	100 pcs(5 pcs)	5010-61380
	100 mg/1 mL	100 pcs(5 pcs)	5010-61381
	200 mg/3 mL	50 pcs(5 pcs)	5010-61382
	500 mg/3 mL	50 pcs(1 pc)	5010-61383
	500 mg/6 mL	30 pcs(1 pc)	5010-61384
	1 g/6 mL	30 pcs(1 pc)	5010-61385
	2 g/12 mL	20 pcs(1 pc)	5010-61386
	5 g/20 mL	20 pcs(1 pc)	5010-61387
	10 g/60 mL	16 pcs(1 pc)	5010-61388

Large-Size Cartridges (LSC)

Description	Bed Weight/Volume	Qty.(pk unit)	Cat.No.
InertSep LSC AL-B	100 mg	50 pcs(1 pc)	5010-63381
	200 mg	50 pcs(1 pc)	5010-63382
	500 mg	50 pcs(1 pc)	5010-63383

Luer-Device Cartridges

Description	Bed Weight/Volume	Qty.(pk unit)	Cat.No.
InertSep Slim-J AL-B	500 mg	50 pcs(5 pcs)	5010-65380
	1000 mg	50 pcs(5 pcs)	5010-65381
	1710 mg	50 pcs(5 pcs)	5010-65382

Bulk Material

Description	Volume	Cat.No.
InertSep AL-B	100 g	5010-69013

1

InertSep Series

InertSep FL(Synthetic Magnesium Silicate)



Average Particle Size : 50-200 μm
 Surface Area : 230 m²/g
 Pore Volume : 0.5 mL/g
 Pore Size : 9 nm

InertSep FL is packed with synthetic magnesium silicate. This sorbent strongly adsorbs polar compounds from none polar matrices and is typically used for sample cleanup of organic extracts.

Syringe-Barrel Cartridges

Description	Bed Weight/Volume	Qty.(pk unit)	Cat.No.
InertSep FL	50 mg/1 mL	100 pcs(5 pcs)	5010-61420
	100 mg/1 mL	100 pcs(5 pcs)	5010-61421
	200 mg/3 mL	50 pcs(5 pcs)	5010-61422
	500 mg/3 mL	50 pcs(1 pc)	5010-61423
	500 mg/6 mL	30 pcs(1 pc)	5010-61424
	1 g/6 mL	30 pcs(1 pc)	5010-61425
	2 g/12 mL	20 pcs(1 pc)	5010-61426
	5 g/20 mL	20 pcs(1 pc)	5010-61427
	10 g/60 mL	16 pcs(1 pc)	5010-61428

Large-Size Cartridges (LSC)

Description	Bed Weight/Volume	Qty.(pk unit)	Cat.No.
InertSep LSC FL	100 mg	50 pcs(1 pc)	5010-63421
	200 mg	50 pcs(1 pc)	5010-63422
	500 mg	50 pcs(1 pc)	5010-63423

Luer-Device Cartridges

Description	Bed Weight/Volume	Qty.(pk unit)	Cat.No.
InertSep Slim-J FL	500 mg	50 pcs(5 pcs)	5010-65420
	900 mg	50 pcs(5 pcs)	5010-65422
	1000 mg	50 pcs(5 pcs)	5010-65421

Bulk Material

Description	Volume	Cat.No.
InertSep FL	100 g	5010-69015

InertSep FL-PR(Synthetic Magnesium Silicate)



Average Particle Size : 100-300 μm
 Surface Area : 230 m²/g
 Pore Volume : 0.5 mL/g
 Pore Size : 9 nm

InertSep FL-PR cartridges are packed with FL-PR, which is used for sample cleanup for analysis of residual pesticides in crops. This sorbent is also suitable for viscous samples and large volume samples to increase the throughput.

Syringe-Barrel Cartridges

Description	Bed Weight/Volume	Qty.(pk unit)	Cat.No.
InertSep FL-PR	50 mg/1 mL	100 pcs(5 pcs)	5010-61440
	100 mg/1 mL	100 pcs(5 pcs)	5010-61441
	200 mg/3 mL	50 pcs(5 pcs)	5010-61442
	500 mg/3 mL	50 pcs(1 pc)	5010-61443
	500 mg/6 mL	30 pcs(1 pc)	5010-61444
	910 mg/20 mL	20 pcs(1 pc)	5010-61453
	1 g/6 mL	30 pcs(1 pc)	5010-61445
	2 g/12 mL	20 pcs(1 pc)	5010-61446
	5 g/20 mL	20 pcs(1 pc)	5010-61447
	10 g/60 mL	16 pcs(1 pc)	5010-61448

Large-Size Cartridges (LSC)

Description	Bed Weight/Volume	Qty.(pk unit)	Cat.No.
InertSep LSC FL-PR	100 mg	50 pcs(1 pc)	5010-63441
	200 mg	50 pcs(1 pc)	5010-63442
	500 mg	50 pcs(1 pc)	5010-63443

Luer-Device Cartridges

Description	Bed Weight/Volume	Qty.(pk unit)	Cat.No.
InertSep Slim-J FL-PR	500 mg	50 pcs(5 pcs)	5010-65440
	900 mg	50 pcs(5 pcs)	5010-65442
	1000 mg	50 pcs(5 pcs)	5010-65441

Bulk Material

Description	Volume	Cat.No.
InertSep FL-PR	100 g	5010-69016

Silica-Based SPE (Ion Exchange)

1

InertSep Series

InertSep CBA

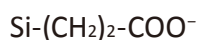

Average Particle Size	: 45 µm
Carbon Load	: 8.5 %
Surface Area	: 450 m ² /g
Pore Volume	: 0.7 mL/g
Pore Size	: 6 nm
Ion exchange capacity	: 1.2 meq/g
pH Range	: 2-8
Remark	: H ⁺ ion pair

InertSep CBA is a silica-based sorbent modified with carboxylethyl functional groups. The primary interactions of this sorbent are cation exchange and the secondary interactions are weak-polar and non-polar. This sorbent is suitable for extraction of drugs with strongly cationic amine groups.

Syringe-Barrel Cartridges

Description	Bed Weight/Volume	Qty.(pk unit)	Cat.No.
InertSep CBA	50 mg/1 mL	100 pcs(5 pcs)	5010-61500
	100 mg/1 mL	100 pcs(5 pcs)	5010-61501
	100 mg/3 mL	50 pcs(5 pcs)	5010-61511
	200 mg/3 mL	50 pcs(5 pcs)	5010-61502
	250 mg/3 mL	50 pcs(1 pc)	5010-61509
	500 mg/3 mL	50 pcs(1 pc)	5010-61503
	250 mg/6 mL	30 pcs(1 pc)	5010-61510
	500 mg/6 mL	30 pcs(1 pc)	5010-61504
	1 g/6 mL	30 pcs(1 pc)	5010-61505
	2 g/12 mL	20 pcs(1 pc)	5010-61506
	5 g/20 mL	20 pcs(1 pc)	5010-61507
	10 g/60 mL	16 pcs(1 pc)	5010-61508

Large-Size Cartridges (LSC)

Description	Bed Weight/Volume	Qty.(pk unit)	Cat.No.
InertSep LSC CBA	100 mg	50 pcs(1 pc)	5010-63501
	200 mg	50 pcs(1 pc)	5010-63502
	500 mg	50 pcs(1 pc)	5010-63503

Luer-Device Cartridges

Description	Bed Weight/Volume	Qty.(pk unit)	Cat.No.
InertSep Slim-J CBA	500 mg	50 pcs(5 pcs)	5010-65500
	1000 mg	50 pcs(5 pcs)	5010-65501

96-Well Plates

Description	Bed Weight/Volume	Qty.	Cat.No.
InertSep 96WP CBA	50 mg	1 pc	5010-66400
	100 mg	1 pc	5010-66401

Bulk Material

Description	Volume	Cat.No.
InertSep CBA	100 g	5010-69017

Silica-Based SPE (Ion Exchange)

1

InertSep Series

InertSep PRS

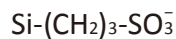

Average Particle Size	: 45 μm
Carbon Load	: 8.5 %
Surface Area	: 450 m ² /g
Pore Volume	: 0.7 mL/g
Pore Size	: 6 nm
Ion exchange capacity	: 1.2 meq/g
pH Range	: 2-8
Remark	: H ⁺ ion pair

InertSep PRS is a silica-based sorbent modified with sulfonylpropyl groups. The primary interactions of this sorbent are anion exchange and secondary interactions are slightly non-polar.

Syringe-Barrel Cartridges

Description	Bed Weight/Volume	Qty.(pk unit)	Cat.No.
InertSep PRS	50 mg/1 mL	100 pcs(5 pcs)	5010-61520
	100 mg/1 mL	100 pcs(5 pcs)	5010-61521
	200 mg/3 mL	50 pcs(5 pcs)	5010-61522
	500 mg/3 mL	50 pcs(1 pc)	5010-61523
	500 mg/6 mL	30 pcs(1 pc)	5010-61524
	1 g/6 mL	30 pcs(1 pc)	5010-61525
	2 g/12 mL	20 pcs(1 pc)	5010-61526
	500 mg/20 mL	20 pcs	5010-61529
	5 g/20 mL	20 pcs(1 pc)	5010-61527
	10 g/60 mL	16 pcs(1 pc)	5010-61528

Large-Size Cartridges (LSC)

Description	Bed Weight/Volume	Qty.(pk unit)	Cat.No.
InertSep LSC PRS	100 mg	50 pcs(1 pc)	5010-63521
	200 mg	50 pcs(1 pc)	5010-63522
	500 mg	50 pcs(1 pc)	5010-63523

Luer-Device Cartridges

Description	Bed Weight/Volume	Qty.(pk unit)	Cat.No.
InertSep Slim-J PRS	500 mg	50 pcs(5 pcs)	5010-65520
	1000 mg	50 pcs(5 pcs)	5010-65521

96-Well Plates

Description	Bed Weight/Volume	Qty.	Cat.No.
InertSep 96WP PRS	50 mg	1 pc	5010-66410
	100 mg	1 pc	5010-66411

Bulk Material

Description	Volume	Cat.No.
InertSep PRS	100 g	5010-69018

Silica-Based SPE (Ion Exchange)

1

InertSep Series

InertSep SCX

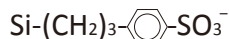

Average Particle Size	: 45 µm
Carbon Load	: 8.5 %
Surface Area	: 450 m ² /g
Pore Volume	: 0.7 mL/g
Pore Size	: 6 nm
Ion exchange capacity	: 0.6 meq/g
pH Range	: 2-8
Remark	: H ⁺ ion pair

InertSep SCX is a silica-based sorbent modified with propylbenzenesulfonyl groups. The primary interactions of this sorbent are both non-polar and strong cation exchange. Because the non-polar interactions on InertSep SCX is stronger than those on InertSep PRS, it is suitable for extractions which require both non-polar interactions and strong cation exchange.

Syringe-Barrel Cartridges

Description	Bed Weight/Volume	Qty.(pk unit)	Cat.No.
InertSep SCX	50 mg/1 mL	100 pcs(5 pcs)	5010-61540
	100 mg/1 mL	100 pcs(5 pcs)	5010-61541
	200 mg/3 mL	50 pcs(5 pcs)	5010-61542
	500 mg/3 mL	50 pcs(1 pc)	5010-61543
	500 mg/6 mL	30 pcs(1 pc)	5010-61544
	500 mg/20 mL	20 pcs(1 pc)	5010-61553
	1 g/6 mL	30 pcs(1 pc)	5010-61545
	2 g/12 mL	20 pcs(1 pc)	5010-61546
	5 g/20 mL	20 pcs(1 pc)	5010-61547
	10 g/60 mL	16 pcs(1 pc)	5010-61548
	20 g/60 mL	16 pcs(1 pc)	5010-61549
	25 g/150 mL	8 pcs(1 pc)	5010-61550
	50 g/150 mL	8 pcs(1 pc)	5010-61551
70 g/150 mL	8 pcs(1 pc)	5010-61552	

Large-Size Cartridges (LSC)

Description	Bed Weight/Volume	Qty.(pk unit)	Cat.No.
InertSep LSC SCX	100 mg	50 pcs(1 pc)	5010-63541
	200 mg	50 pcs(1 pc)	5010-63542
	500 mg	50 pcs(1 pc)	5010-63543

Luer-Device Cartridges

Description	Bed Weight/Volume	Qty.(pk unit)	Cat.No.
InertSep Slim-J SCX	500 mg	50 pcs(5 pcs)	5010-65540
	1000 mg	50 pcs(5 pcs)	5010-65541

96-Well Plates

Description	Bed Weight/Volume	Qty.	Cat.No.
InertSep 96WP SCX	50 mg	1 pc	5010-66420
	100 mg	1 pc	5010-66421

Bulk Material

Description	Volume	Cat.No.
InertSep SCX	100 g	5010-69019

Silica-Based SPE (Ion Exchange)

1

InertSep Series

InertSep SCX-2

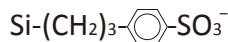

Average Particle Size	: 60 μm
Carbon Load	: 17 %
Surface Area	: 450 m ² /g
Pore Volume	: 0.7 mL/g
Pore Size	: 6 nm
Ion exchange capacity	: 1.2 meq/g
pH Range	: 2-8
Remark	: H ⁺ ion pair

InertSep SCX-2 employs the same chemical modification with InertSep SCX. The only difference is that propylbenzenesulfonyl groups are bonded more densely on the silica surface to increase ion exchange capacity and retentivity.

Syringe-Barrel Cartridges

Description	Bed Weight/Volume	Qty.(pk unit)	Cat.No.
InertSep SCX-2	50 mg/1 mL	100 pcs(5 pcs)	5010-61720
	100 mg/1 mL	100 pcs(5 pcs)	5010-61721
	200 mg/3 mL	50 pcs(5 pcs)	5010-61722
	500 mg/3 mL	50 pcs(1 pc)	5010-61723
	500 mg/6 mL	30 pcs(1 pc)	5010-61724
	500 mg/20 mL	20 pcs(1 pc)	5010-61733
	1 g/6 mL	30 pcs(1 pc)	5010-61725
	2 g/12 mL	20 pcs(1 pc)	5010-61726
	5 g/20 mL	20 pcs(1 pc)	5010-61727
	10 g/60 mL	16 pcs(1 pc)	5010-61728
	20 g/60 mL	16 pcs(1 pc)	5010-61729
	25 g/150 mL	8 pcs(1 pc)	5010-61730
	50 g/150 mL	8 pcs(1 pc)	5010-61731
70 g/150 mL	8 pcs(1 pc)	5010-61732	

Large-Size Cartridges (LSC)

Description	Bed Weight/Volume	Qty.(pk unit)	Cat.No.
InertSep LSC SCX-2	100 mg	50 pcs(1 pc)	5010-63661
	200 mg	50 pcs(1 pc)	5010-63662
	500 mg	50 pcs(1 pc)	5010-63663

Luer-Device Cartridges

Description	Bed Weight/Volume	Qty.(pk unit)	Cat.No.
InertSep Slim-J SCX-2	500 mg	50 pcs(5 pcs)	5010-65660
	1000 mg	50 pcs(5 pcs)	5010-65661

96-Well Plates

Description	Bed Weight/Volume	Qty.	Cat.No.
InertSep SCX-2	50 mg	1 pc	5010-66430
	100 mg	1 pc	5010-66431

Bulk Material

Description	Volume	Cat.No.
InertSep SCX-2	100 g	5010-69034

Silica-Based SPE (Ion Exchange)

InertSep NH2

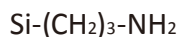

Average Particle Size : 60 μm
 Carbon Load : 10 %
 Surface Area : 450 m²/g
 Pore Volume : 0.7 mL/g
 Pore Size : 6 nm
 Ion exchange capacity : 0.9 meq/g
 pH Range : 2-8

InertSep NH2 is a silica-based sorbent modified with an aminopropyl groups. Anion exchange and polar interaction are combined as the primary interactions. As the secondary interactions, it has weak non-polar interactions. Similar to InertSep 2OH and InertSep SI used in normal phase mode, InertSep NH2 can be used for the separation of structural isomers.

Syringe-Barrel Cartridges

Description	Bed Weight/Volume	Qty.(pk unit)	Cat.No.
InertSep NH2	50 mg/1 mL	100 pcs(5 pcs)	5010-61600
	100 mg/1 mL	100 pcs(5 pcs)	5010-61601
	200 mg/3 mL	50 pcs(5 pcs)	5010-61602
	500 mg/3 mL	50 pcs(1 pc)	5010-61603
	500 mg/6 mL	30 pcs(1 pc)	5010-61604
	1 g/6 mL	30 pcs(1 pc)	5010-61605
	2 g/12 mL	20 pcs(1 pc)	5010-61606
	5 g/20 mL	20 pcs(1 pc)	5010-61607
	10 g/60 mL	16 pcs(1 pc)	5010-61608
	20 g/60 mL	16 pcs(1 pc)	5010-61609
	25 g/150 mL	8 pcs(1 pc)	5010-61610
	50 g/150 mL	8 pcs(1 pc)	5010-61611
	70 g/150 mL	8 pcs(1 pc)	5010-61612

Large-Size Cartridges (LSC)

Description	Bed Weight/Volume	Qty.(pk unit)	Cat.No.
InertSep LSC NH2	100 mg	50 pcs(1 pc)	5010-63601
	200 mg	50 pcs(1 pc)	5010-63602
	500 mg	50 pcs(1 pc)	5010-63603

Luer-Device Cartridges

Description	Bed Weight/Volume	Qty.(pk unit)	Cat.No.
InertSep Slim-J NH2	500 mg	50 pcs(5 pcs)	5010-65600
	1000 mg	50 pcs(5 pcs)	5010-65601
InertSep Slim NH2	360 mg	50 pcs(5 pcs)	5010-65605

96-Well Plates

Description	Bed Weight/Volume	Qty.	Cat.No.
InertSep 96WP NH2	50 mg	1 pc	5010-66600
	100 mg	1 pc	5010-66601

Bulk Material

Description	Volume	Cat.No.
InertSep NH2	100 g	5010-69020

InertSep NH2 FF

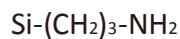

Average Particle Size	: 120 μm
Carbon Load	: 10 %
Surface Area	: 450 m ² /g
Pore Volume	: 0.7 mL/g
Pore Size	: 6 nm
Ion exchange capacity	: 0.9 meq/g
pH Range	: 2-8

InertSep NH2 FF is a modified version of InertSep NH2 for high flow lates. This sorbent is also suitable for viscous samples and large volume samples to increase the throughput.

Syringe-Barrel Cartridges

Description	Bed Weight/Volume	Qty.(pk unit)	Cat.No.
InertSep NH2 FF	50 mg/1 mL	100 pcs(5 pcs)	5010-62600
	100 mg/1 mL	100 pcs(5 pcs)	5010-62601
	200 mg/3 mL	50 pcs(5 pcs)	5010-62602
	500 mg/3 mL	50 pcs(1 pc)	5010-62603
	500 mg/6 mL	30 pcs(1 pc)	5010-62604
	1 g/6 mL	30 pcs(1 pc)	5010-62605
	2 g/12 mL	20 pcs(1 pc)	5010-62606
	5 g/20 mL	20 pcs(1 pc)	5010-62607
	10 g/60 mL	16 pcs(1 pc)	5010-62608
	20 g/60 mL	16 pcs(1 pc)	5010-62609
	25 g/150 mL	8 pcs(1 pc)	5010-62610
	50 g/150 mL	8 pcs(1 pc)	5010-62611
	70 g/150 mL	8 pcs(1 pc)	5010-62612

Large-Size Cartridges (LSC)

Description	Bed Weight/Volume	Qty.(pk unit)	Cat.No.
InertSep LSC NH2 FF	100 mg	50 pcs(1 pc)	5010-64601
	200 mg	50 pcs(1 pc)	5010-64602
	500 mg	50 pcs(1 pc)	5010-64603

Bulk Material

Description	Volume	Cat.No.
InertSep NH2 FF	100 g	5010-69031

Silica-Based SPE (Ion Exchange)

InertSep PSA

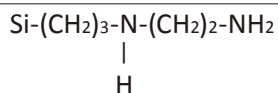

Average Particle Size	: 60 μm
Carbon Load	: 11.5 %
Surface Area	: 450 m ² /g
Pore Volume	: 0.7 mL/g
Pore Size	: 6 nm
Ion exchange capacity	: 1.5 meq/g
pH Range	: 2-8

InertSep PSA is a silica-based sorbent modified with ethylene-diamine-Npropyl groups. The primary interactions of this sorbent are anion exchange and secondary interactions are weak non-polar.

Syringe-Barrel Cartridges

Description	Bed Weight/Volume	Qty.(pk unit)	Cat.No.
InertSep PSA	50 mg/1 mL	100 pcs(5 pcs)	5010-61620
	100 mg/1 mL	100 pcs(5 pcs)	5010-61621
	200 mg/3 mL	50 pcs(5 pcs)	5010-61622
	500 mg/3 mL	50 pcs(1 pc)	5010-61623
	500 mg/6 mL	30 pcs(1 pc)	5010-61624
	500 mg/20 mL	20 pcs(1 pc)	5010-61629
	1 g/6 mL	30 pcs(1 pc)	5010-61625
	2 g/12 mL	20 pcs(1 pc)	5010-61626
	5 g/20 mL	20 pcs(1 pc)	5010-61627
	10 g/60 mL	16 pcs(1 pc)	5010-61628

Large-Size Cartridges (LSC)

Description	Bed Weight/Volume	Qty.(pk unit)	Cat.No.
InertSep LSC PSA	100 mg	50 pcs(1 pc)	5010-63621
	200 mg	50 pcs(1 pc)	5010-63622
	500 mg	50 pcs(1 pc)	5010-63623

Luer-Device Cartridges

Description	Bed Weight/Volume	Qty.(pk unit)	Cat.No.
InertSep Slim-J PSA	500 mg	50 pcs(5 pcs)	5010-65620
	1000 mg	50 pcs(5 pcs)	5010-65621

96-Well Plates

Description	Bed Weight/Volume	Qty.	Cat.No.
InertSep 96WP PSA	50 mg	1 pc	5010-66610
	100 mg	1 pc	5010-66611

Bulk Material

Description	Volume	Cat.No.
InertSep PSA	100 g	5010-69021

Silica-Based SPE (Ion Exchange)

1

InertSep Series

InertSep SAX

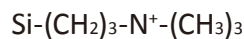

Average Particle Size : 45 μm
 Carbon Load : 7 %
 Surface Area : 450 m^2/g
 Pore Volume : 0.7 mL/g
 Pore Size : 6 nm
 Ion exchange capacity : 0.7 meq/g
 pH Range : 2-8
 Remark : OH^- ion pair

InertSep SAX is a silica-based sorbent modified with trimethylaminopropyl groups. Primary interactions are very strong anion exchange. Secondary interactions are non-polar. It is generally used for the extraction of weak anions such as carboxylic acids.

Syringe-Barrel Cartridges

Description	Bed Weight/Volume	Qty.(pk unit)	Cat.No.
InertSep SAX	50 mg/1 mL	100 pcs(5 pcs)	5010-61640
	100 mg/1 mL	100 pcs(5 pcs)	5010-61641
	150 mg/3 mL	50 pcs(5 pcs)	5010-61654
	200 mg/3 mL	50 pcs(5 pcs)	5010-61642
	360 mg/3 mL	50 pcs(5 pcs)	5010-61655
	500 mg/3 mL	50 pcs(1 pc)	5010-61643
	500 mg/6 mL	30 pcs(1 pc)	5010-61644
	1 g/6 mL	30 pcs(1 pc)	5010-61645
	2 g/12 mL	20 pcs(1 pc)	5010-61646
	5 g/20 mL	20 pcs(1 pc)	5010-61647
	10 g/60 mL	16 pcs(1 pc)	5010-61648
	20 g/60 mL	16 pcs(1 pc)	5010-61649
	25 g/150 mL	8 pcs(1 pc)	5010-61650
	50 g/150 mL	8 pcs(1 pc)	5010-61651
	70 g/150 mL	8 pcs(1 pc)	5010-61652

Large-Size Cartridges (LSC)

Description	Bed Weight/Volume	Qty.(pk unit)	Cat.No.
InertSep LSC SAX	100 mg	50 pcs(1 pc)	5010-63641
	200 mg	50 pcs(1 pc)	5010-63642
	500 mg	50 pcs(1 pc)	5010-63643

Luer-Device Cartridges

Description	Bed Weight/Volume	Qty.(pk unit)	Cat.No.
InertSep Slim-J SAX	500 mg	50 pcs(5 pcs)	5010-65640
	1000 mg	50 pcs(5 pcs)	5010-65641

96-Well Plates

Description	Bed Weight/Volume	Qty.	Cat.No.
InertSep 96WP SAX	50 mg	1 pc	5010-66620
	100 mg	1 pc	5010-66621

Bulk Material

Description	Volume	Cat.No.
InertSep SAX	100 g	5010-69022

Silica-Based SPE (Ion Exchange)

InertSep SAX-2

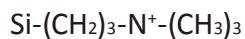

Average Particle Size : 60 μm
 Carbon Load : 11.5 %
 Surface Area : 450 m²/g
 Pore Volume : 0.7 mL/g
 Pore Size : 6 nm
 Ion exchange capacity : 0.45 meq/g
 pH Range : 2-8
 Remark : Cl⁻ ion pair

InertSep SAX-2 is a modified version of InertSep SAX for stronger non-polar interactions.

Syringe-Barrel Cartridges

Description	Bed Weight/Volume	Qty.(pk unit)	Cat.No.
InertSep SAX-2	50 mg/1 mL	100 pcs(5 pcs)	5010-61700
	100 mg/1 mL	100 pcs(5 pcs)	5010-61701
	200 mg/3 mL	50 pcs(5 pcs)	5010-61702
	500 mg/3 mL	50 pcs(1 pc)	5010-61703
	500 mg/6 mL	30 pcs(1 pc)	5010-61704
	500 mg/20 mL	20 pcs(1 pc)	5010-61713
	1 g/6 mL	30 pcs(1 pc)	5010-61705
	2 g/12 mL	20 pcs(1 pc)	5010-61706
	5 g/20 mL	20 pcs(1 pc)	5010-61707
	10 g/60 mL	16 pcs(1 pc)	5010-61708
	20 g/60 mL	16 pcs(1 pc)	5010-61709
	25 g/150 mL	8 pcs(1 pc)	5010-61710
	50 g/150 mL	8 pcs(1 pc)	5010-61711
	70 g/150 mL	8 pcs(1 pc)	5010-61712

Large-Size Cartridges (LSC)

Description	Bed Weight/Volume	Qty.(pk unit)	Cat.No.
InertSep LSC SAX-2	100 mg	50 pcs(1 pc)	5010-63651
	200 mg	50 pcs(1 pc)	5010-63652
	500 mg	50 pcs(1 pc)	5010-63653

Luer-Device Cartridges

Description	Bed Weight/Volume	Qty.(pk unit)	Cat.No.
InertSep Slim-J SAX-2	500 mg	50 pcs(5 pcs)	5010-65650
	1000 mg	50 pcs(5 pcs)	5010-65651

96-Well Plates

Description	Bed Weight/Volume	Qty.	Cat.No.
InertSep 96WP SAX-2	50 mg	1 pc	5010-66640
	100 mg	1 pc	5010-66641

Bulk Material

Description	Volume	Cat.No.
InertSep SAX-2	100 g	5010-69033

InertSep Slim-J AC (Active Carbon)



InertSep Slim-J AC

Base Gel : Active Carbon
 Average Particle Size : 60/150 mesh
 Surface Area : 800-1200 m²/g

InertSep Slim-J AC cartridges are packed with active carbon particles uniformly size classified for liquid permeability. As ultra-pure active carbon is employed, it is clear of worry about contamination. Good retentivity of this sorbent even for highly polar compounds ensure high recovery and reproducibility. Lure device format supports automation of SPE procedure.

Description	Bed Weight/Volume	Qty.	Cat.No.
InertSep Slim-J AC	400 mg	50 pcs	5010-25500

InertSep GC (Carbograph, Graphite Carbon)



InertSep GC

Base Gel : Graphite Carbon
 Average Particle Size : 120/400 mesh
 Surface Area : 85 m²/g
 Pore Volume : 1 mL/g
 Pore Size : 45 nm

InertSep GC cartridges are packed with graphite carbon in planar structure. They are generally used for removal of pigments from crop homogenates. In conjunction with other various normal phase sorbents and ion exchange sorbents, these cartridges are able to be used for a wide variety of applications as a cleanup sorbent.

Syringe-Barrel Cartridges

Description	Bed Weight/Volume	Qty.(pk unit)	Cat.No.
InertSep GC	100 mg/3 mL	50 pcs(10 pcs)	5010-68007
	150 mg/3 mL	50 pcs(10 pcs)	5010-68000
	250 mg/3 mL	50 pcs(10 pcs)	5010-68005
	300 mg/6 mL	30 pcs(10 pcs)	5010-68001
	500 mg/6 mL	30 pcs(10 pcs)	5010-68002
	1 g/12 mL	20 pcs(10 pcs)	5010-68003
	2 g/12 mL	20 pcs(20 pcs)	5010-68006
	500 mg/20 mL	20 pcs(10 pcs)	5010-68004

Luer-Device Cartridges

Description	Bed Weight/Volume	Qty.(pk unit)	Cat.No.
InertSep Slim GC	400 mg	50 pcs(5 pcs)	5010-65710

Bulk Material

Description	Volume	Cat.No.
InertSep GC	10 g	5010-69050
InertSep GC	100 g	5010-69051

InertSep GC/NH₂, GC/PSA

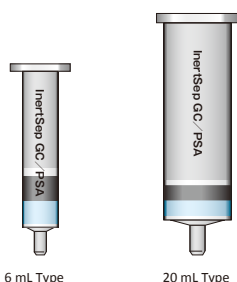

These two layer cartridges are packed with graphite carbon for removing pigments and NH₂ or PSA sorbent for sample cleanup of organic extracts. This consolidation of two layers achieves high sample cleanup performance which cannot be obtained only on one layer.

Two Layer Syringe-Barrel Type

Description	Bed Weight/Volume	Qty.(pk unit)	Cat.No.
InertSep GC/NH ₂	250 mg/250 mg/3 mL	50 pcs(10 pcs)	5010-68020
	500 mg/500 mg/6 mL	30 pcs(10 pcs)	5010-68022
	500 mg/500 mg/20 mL	20 pcs(10 pcs)	5010-68024
	1 g/500 mg/6 mL	30 pcs(10 pcs)	5010-68023
	1 g/1 g/20 mL	20 pcs(10 pcs)	5010-68025
InertSep GC/PSA	50 mg/50 mg/1 mL	50 pcs	5010-68016
	50 mg/125 mg/1 mL	50 pcs	5010-68017
	300 mg/500 mg/6 mL	30 pcs(10 pcs)	5010-68011
	500 mg/500 mg/6 mL	30 pcs(10 pcs)	5010-68012
	500 mg/500 mg/20 mL	20 pcs(10 pcs)	5010-68014
	1 g/1 g/20 mL	20 pcs(10 pcs)	5010-68015
	1 g/500 mg/6 mL	30 pcs(10 pcs)	5010-68013

InertSep SAX/PSA

InertSep SAX/PSA is a two-layer SPE cartridge packed with SAX and PSA. It is specifically used to remove agrochemical compounds that are often difficult to remove from crop samples by polar interactions.

Two Layer Syringe-Barrel Type

Description	Bed Weight/Volume	Qty.(pk unit)	Cat.No.
InertSep SAX/PSA	250 mg/250 mg/3 mL	50 pcs(10 pcs)	5010-68100
	500 mg/500 mg/6 mL	30 pcs(10 pcs)	5010-68101
	500 mg/500 mg/20 mL	20 pcs(10 pcs)	5010-68104
	1 g/1 g/20 mL	20 pcs(10 pcs)	5010-68105

InertSep GC/PSA/SI, GC/SAX/PSA

InertSep GC/PSA/SI is more efficient for removing a wide variety of polar matrix compounds than GC/PSA. InertSep GC/SAX/PSA are able to be used for cleanup of processed food.

Three Layer Syringe-Barrel Type

Description	Bed Weight/Volume	Qty.(pk unit)	Cat.No.
InertSep GC/PSA/SI	500 mg/500 mg/500 mg/20 mL	20 pcs(10 pcs)	5010-68034
InertSep GC/SAX/PSA	500 mg/500 mg/500 mg/20 mL	20 pcs(10 pcs)	5010-68044

InertSep GC/SAX/PSA/SI

InertSep GC/SAX/PSA/SI is a four layer SPE cartridge. GC has ability for the isolation removal of pigments and SAX, PSA and SI offer superior cleanup when conducting multi-residue pesticide analysis.

Four Layer Syringe-Barrel Type

Description	Bed Weight/Volume	Qty.(pk unit)	Cat.No.
InertSep GC/SAX/PSA/SI	500 mg/500 mg/500 mg/500 mg /20 mL	20 pcs(10 pcs)	5010-68054

InertSep SAX/PSA/SI

InertSep SAX/PSA/SI is a three-layer SPE cartridge for cleanup. It is available for sample cleanup to make analysis of residual pesticides.

Three Layer Syringe-Barrel Type

Description	Bed Weight/Volume	Qty.(pk unit)	Cat.No.
InertSep SAX/PSA/SI	500 mg/500 mg/500 mg /20 mL	20 pcs(10 pcs)	5010-68114

InertSep C18/DRY

InertSep C18/DRY is a two-layer SPE cartridge and designed for sample preparation for residual pesticide analysis. C18 is to remove lipids and DRY is for dehydration.

Two Layer Syringe-Barrel Type

Description	Bed Weight/Volume	Qty.(pk unit)	Cat.No.
InertSep C18/DRY	1 g/3 g/12 mL	20 pcs(1 pc)	5010-68133

InertSep C18/SAX/PSA,AL-N/C18/SAX/PSA

Three- and four-layer-type solid phase extraction cartridges are used for rapid simultaneous analysis of pesticide residues. Since graphite carbon is not used, the purification process can be performed with only a small amount of acetonitrile solvent without toluene. For particularly pigmented samples, the four-layer-type AL-N/C18/SAX/PSA can be recommend.

Three and Four-Layer Syringe-Barrel Type

Description	Bed Weight/Volume	Qty.	Cat.No.
InertSep C18/SAX/PSA	200 mg/100 mg/100 mg/1 mL	100 pcs	5010-68110
InertSep AL-N/C18/SAX/PSA	100 mg/200 mg/100 mg/100 mg/1 mL	50 pcs	5010-68111

InertSep Slim-J DRY

Na₂SO₄

InertSep Slim-J DRY cartridge is packed with anhydrous Na₂SO₄ for dehydration.

Luer-Device Cartridges

Description	Bed Weight/Volume	Qty.(pk unit)	Cat.No.
InertSep Slim-J DRY	1.4 g	50 pcs(1 pc)	5010-65700
	2.8 g	50 pcs(1 pc)	5010-65701

InertSep PCB

InertSep PCB is a two-layer SPE cartridge packed with SCX and SI. It has been designed for the extraction of PCBs from complex matrix.

Syringe-Barrel Cartridges

Description	Bed Weight/Volume	Qty.(pk unit)	Cat.No.
InertSep PCB	1 g/3 mL	50 pcs(5 pcs)	5010-68121
	1 g/6 mL	30 pcs(1 pc)	5010-68120

InertSep Phospholipid Remover



InertSep Phospholipid has both excellent phospholipid removal ability and low adsorption, and can be used for serum and plasma samples, etc.

Description	Bed Weight/Volume	Qty	Cat.No.
InertSep Phospholipid Remover	50 mg/1 mL	100 pcs	5010-27810
	100 mg/3 mL	50 pcs	5010-27811

InertSep K-solute(Diatomaceous earth)



InertSep K-solute

InertSep K-solute is packed with diatomaceous earth and ideal for the sample to form an emulsion during liquid-liquid extraction procedures. Dedicated rack for InertSep makes the operation simple and efficient further more.

Reservoir dimensions

Volume of Used Reservoir	O.D.	Length
12 mL	18 mm	90 mm
20 mL	23 mm	99 mm
60 mL	30 mm	155 mm
150 mL	41 mm	172 mm

Procedure 1 Apply a sample to InertSep K-solute



Procedure 2 Leave it to stand for 5 to 15 minutes



Procedure 3 Elute with an elution solvent

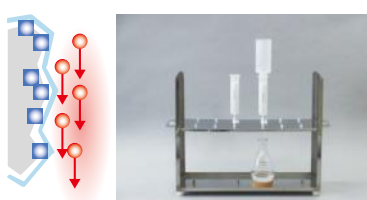

Syringe-Barrel Cartridges

Description	Reservoir Volume	Sample Volume	Qty.	Cat.No.
InertSep K-solute	12 mL	2 mL	100 pcs	5010-68125
			100 pcs	5010-68127
	60 mL	10 mL	25 pcs	5010-68208
			100 pcs	5010-68218
		20 mL	25 pcs	5010-68209
			100 pcs	5010-68219
	150 mL	50 mL	25 pcs	5010-68210
			50 pcs	5010-68220

Bulk

Description	Qty.	Cat.No.
Sorbent Supported Liquid Extraction (Bulk)	1 kg	5010-69500

Adaptors

Description	Qty.	Cat.No.
Connecting Adaptor (PP) 1, 3, 6 mL Reservoir	12 pcs	5010-60000
Connecting Adaptor (PP) 12, 20 mL Reservoir	12 pcs	5010-60001
Connecting Adaptor (PP) 60 mL Reservoir	12 pcs	5010-60002
Connecting Adaptor (PP) 150 mL Reservoir	1 pc	5010-50336
Connecting Adaptor (PP) LSC Reservoir	12 pcs	5010-60004

Reservoir with Adaptors

Description	Qty.	Cat.No.
Reservoir with Adaptor for 1, 3, 6 mL	12 pcs	5010-60015
50 mL Reservoir with Adaptor for 12, 20 mL	12 pcs	5010-60016
200 mL Reservoir with Adaptor for 60 mL	12 pcs	5010-60017

InertSep VRA (Multifunctional Cleanup SPE Cartridge for Aflatoxins)

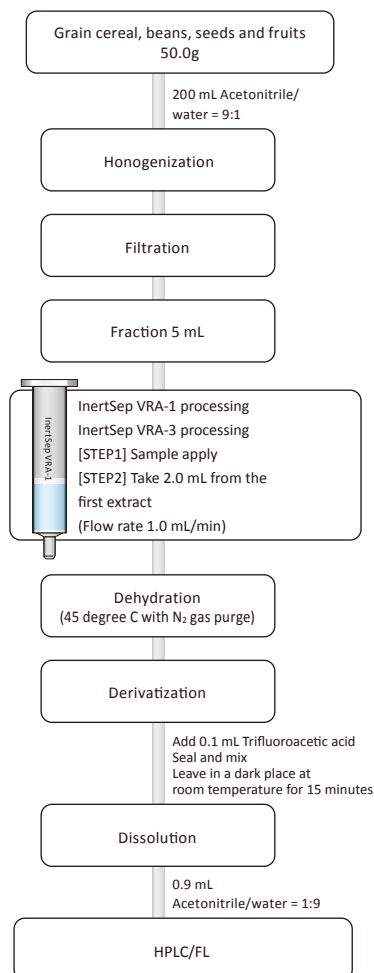

Total Aflatoxin Analysis

A number of mycotoxins are contained in natural food products. Among these, Aflatoxins produced by fungus such as *Aspergillus flavus* are carcinogenic to liver cells, and have attracted considerable attention in food safety.

InertSep VRA Series

InertSep VRA series are multifunctional solid phase extraction cartridges for cleanup samples in complex organic matrices.

● Feature

These multifunctional cartridges have the advantages of both reversed phase and ion exchange silica-based sorbents.

Description	Details	Qty.	Cat.No.
InertSep VRA-1	Mix mode: Reversed and ion exchange phase (Column size : 6 mL)	30 pcs	5010-68140
InertSep VRA-2	Economy model of VRA-1 (Column size : 6 mL)	30 pcs	5010-68141
InertSep VRA-3	Strong reversed phase model (Column size : 6 mL)	30 pcs	5010-68142

InertSep VRA-RP (Multifunctional Cleanup SPE Cartridge for pesticide residue analysis and biological samples)

InertSep VRA-PR

InertSep VRA-PR is a solid-phase mini-column for trace cleanup in biological samples and for cleanup of QuEChERS samples in pesticide residue analysis.

For removal of strong pigment components, columns stacked with "AL-N" are recommended.

● Feature

- These multifunctional cartridges have the advantages of both reversed phase and ion exchange silica-based sorbents.

Description	Bed Weight/Volume	Qty.	Cat.No.
InertSep VRA-PR	400mg/1mL	100 pcs	5010-68153
InertSep VRA-PR	1600mg/6mL	30 pcs	5010-68154
InertSep AL-N/VRA-PR	100mg/50mg/1mL	100 pcs	5010-68150
InertSep AL-N/VRA-PR	400mg/1600mg/6mL	30 pcs	5010-68151
InertSep AL-N/VRA-PR	100mg/400mg/1mL	100 pcs	5010-68152

InertSep mini AERO series

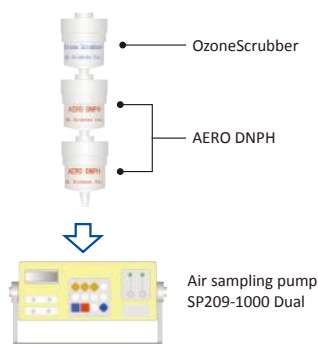

Ex 1) How to use InertSep mini AERO

Note) Use the OzoneScrubber depending on the requirement

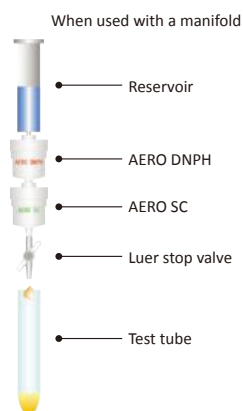

Ex 2) How to use InertSep mini AERO

InertSep mini AERO series are active samplers for the analysis of aldehydes and ketones in outdoor gas, car cabin and exhaust gas in compliance with: Offensive Odor Control Law, Clean Air Act, and EPA. There are four types: AERO DNPH, AERO DNPH-HR, AERO OzoneScrubber, and AERO SC, InertSep mini AERO series.

● Features

InertSep mini AERO DNPH

This active sampler is packed with spherical silica coated with 2,4-Dinitrophenylhydrazine reagent for derivatization of aldehydes and ketones. The size of 120 μm spherical silica allows for high air permeability, resulting in high collection efficiency of the target compounds and low blank compared with irregular silica.

InertSep mini AERO DNPH-HR

This is newly developed and offers improved efficiency for acrolein collection, which is difficult to collect with the conventional DNPH cartridges.

InertSep mini AERO OzoneScrubber

Potassium iodide is used to remove ozone interference. It is known that the DNPH derivatives are decomposed by ozone, which affects the results. InertSep AERO OzoneScrubber is used in series with DNPH cartridge at its inlet side.

InertSep mini AERO SC

This cartridge is packed with polymeric packing material of strong cation exchange to remove unreacted DNPH.

Unreacted DNPH interferes with GC analysis, so is connected to the outlet side of DNPH cartridge.

Description	Bed Weight	Qty.	Cat.No.
InertSep mini AERO DNPH [●R/F]	300 mg	20 pcs	5010-23500
InertSep mini AERO DNPH-HR [●R/F]	300 mg	20 pcs	5010-23501
InertSep mini AERO OzoneScrubber	1.5 g	20 pcs	5010-23510
InertSep mini AERO SC	250 mg	20 pcs	5010-23520

Note: [●R/F] Refrigerated/Freezing

InertSep Slim-J AERO SDB400

InertSep Slim-J AERO SDB400 is used for extraction of semi-volatile organic compounds like insecticides and fire retardants in air.

Description	Bed Weight	Qty.	Cat.No.
InertSep Slim-J AERO SDB400	400 mg	20 pcs	5010-65780



2. Accessories for SPE

● Vacuum Manifold	64
● Reservoir and Adaptor	68
● Tube	70
● Gravity Flow Manifold	72
● Other Accessories	75
● Syringe Filter	76

Introduction of InertSep Vacuum Manifold System

InertSep vacuum manifold is specially developed for performing efficient solid phase extraction. According to the application there are various kinds of useful kits and options.

2

Accessories for SPE

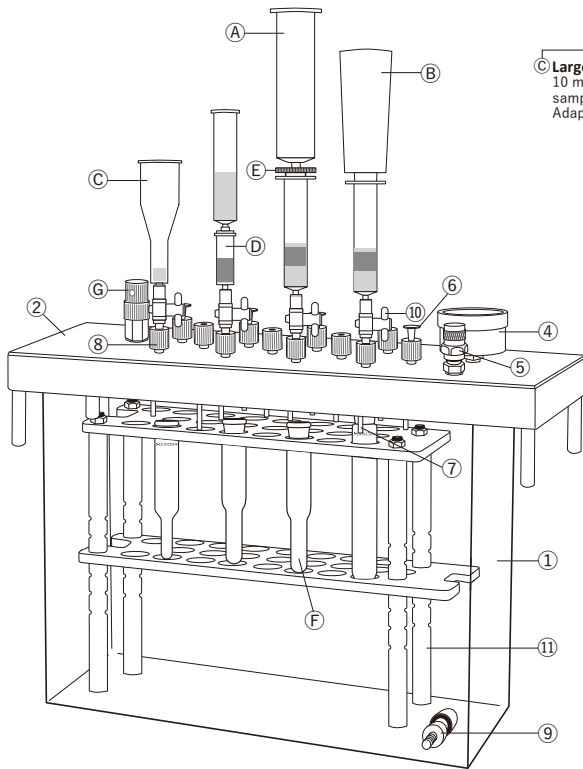

C Large Size Cartridge
10 mL reservoir used with samples up to 10 mL. Adaptor not required.

A Empty Reservoir
1 mL to 150 mL reservoirs are available for large sample amount. Requires a connecting adaptor.

B Reservoir with adaptor
Ideal for use in the pretreatment of food. Useful when using a cleanup volume of 20 mL approx.

D Luer Device Cartridge
Used for connecting a solid phase cartridge, connecting an empty reservoir or connection to a automatically instrument for solid phase extraction.

E Connecting adaptor for InertSep
Used to connect a syringe barrel type regular cartridge to another luer device.

10 5010-60010 Luer Stop Valve (PTFE)
Used to control or stop the flow rate during solid phase extraction.

2 5010-50238 Top Cover Assembly
Fit onto the glass chamber to perform solid phase extraction.

G Safety valve
Used to prevent excessive applied vacuum breaking the glass chamber.

6 5010-50016 Sealing plug
Need to plug any line not being used.

4 5010-50014 Vacuum gauge
Display the level of vacuum in the glass chamber.

5 5010-50015 Bleed valve
Used to adjust the amount of vacuum applied. Adjust while monitoring the pressure displayed on the vacuum gauge.

8 5010-50032 PTFE Luer fitting
A luer type connection can be made, e.g. with a solid phase cartridge or filter disk. Also used to connect the delivery tips to the cover.

7 5010-50019, 5010-50020 Delivery Tips
The standard delivery tip is manufactured from stainless steel (5010-50019). When correction resistance is required, use the PTFE type (5010-50020).

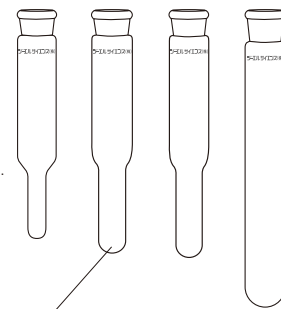

F 5010-51010 etc, GL-SPE
Concentration tubes There are 11 different sizes. Select, depending on the volume of the extraction solvent and concentration volume.

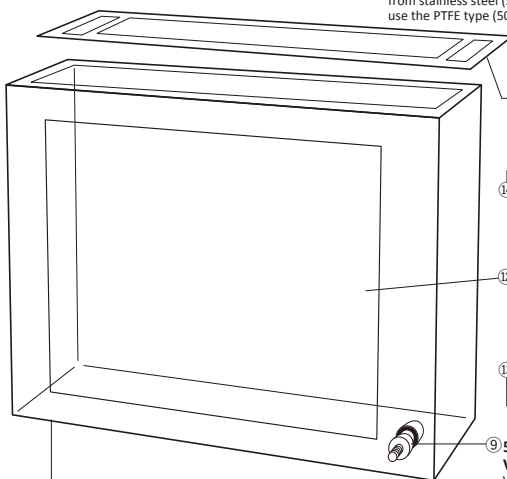

3 5010-50239 Gasket
Used to seal the cover assembly and the glass chamber to maintain vacuum.

14 5010-50018 Stainless steel nut for rack
5010-50129 Hexagon nut M6x4 for rack

12 5010-50041 Glass protection film

13 5010-50017 O-ring
5010-50128 Resin clip for rack

9 5010-50033 Vacuum tube connector assembly
Vacuum tube connector Used to connect the glass chamber to the vacuum pump.

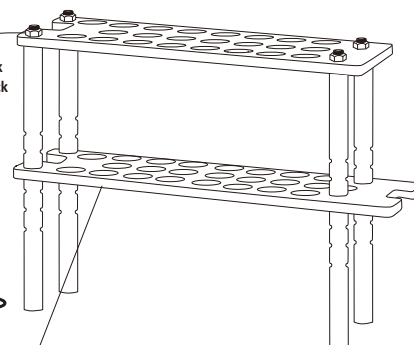

11 5010-50240 Bottom plate
There 5 type of racks: 12/16 mm test tube, 20 mL concentration tube, 30 mL Concentration tube, TS 29/38 eggplant shaped flask, TS 29/38 Florence flask 50/100 mL.

InertSep Vacuum Manifold Kit



5010-50230



5010-50234



5010-50235



5010-50233

For the efficient SPE analysis using InertSep vacuum manifold system, necessary accessories are provided as a kit for general or environmental analysis which needed many samples such as river water. Some kits are suitable for your analytical purposes.

Description	Specification	Qty.	Cat.No.
InertSep Vacuum Manifold Kit 12/16 mm (for Test Tube/ Concentration Tube) 12 Samples	Glass Chamber: 1 pc Cover 1 pc Gasket 1 pc Vacuum Gauge 1 pc Bleed Valve 1 pc Safety Valve 1 pc Plug 12 pcs Cartridge Adaptor 12 pcs PTFE Female Luer 12 pcs Stainless Delivery Tip 12 pcs PTFE Delivery Tip 12 pcs 12/16 mm Rack 1 pc 12 mm Waste Liquid Funnel 12 pcs 16 mm Waste Liquid Funnel 12 pcs	1 set	5010-50230
InertSep Vacuum Manifold Kit (for 4 Eggplantshaped Flasks)	Glass Chamber: 1 pc Cover 1 pc Gasket 1 pc Vacuum Gauge 1 pc Bleed Valve 1 pc Safety Valve 1 pc Plug 4 pcs PTFE Female Luer 12 pcs Stainless Delivery Tip 12 pcs TS29/38 Rack for 4 Florence Flasks 1 pc PTFE Delivery Tip 4 pcs	1 set	5010-50234
InertSep Vacuum Manifold Kit 20 (for 20 samples-20/30 mL Concentration Tube)	Glass Chamber 1 pc Gasket 1 pc, plug 20 pcs Stainless Delivery Tip 20 pcs PTFE Delivery Tip 20 pcs Rack for 20/30 mL Concentration Tube 1 pc Vacuum Controller 1 pc	1 set	5010-50235
InertSep Vacuum Manifold Kit for Inorganic Analysis For 50 mL DigiTUBE/8 Samples	Glass chamber 1 pc Cover (for 8 samples) 1 pc Gasket 1 pc Vacuum Gauge (SUS) 1 pc Bleed Valve (SUS) 1 pc Safety Valve (SUS) 1 pc Plug 8 pcs Luer Stop Valve (PTFE) 8 pcs PTFE Female Luer 8 pcs Delivery Tip (PTFE) 8 pcs DigiTUBE Rack 1 pc	1 set	5010-50233

*Parts used for inorganic analysis are made of different materials. See page 67 for details.

SPE Vacuum Kit



5010-50040

The SPE Vacuum Kit is used in combination with the InertSEP aspiration manifold for solid phase extraction. The starter kit is a basic vacuum kit combined with a concentration tube and other components.

Description	Specification	Qty.	Cat.No.
SPE Vacuum Kit	Diaphragm vacuum pump Suction Filtration Bottle Vacuum Hose 2 m Silicon Plug Hose connector	1 set	5010-50040

Option for SPE Vacuum kit

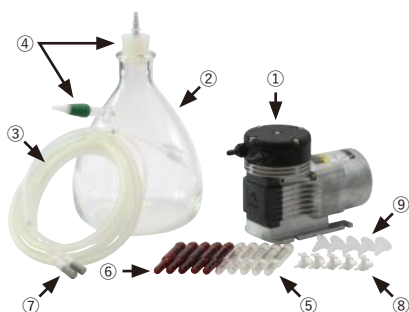

Option for SPE Vacuum kit

No.	Description	Specification	Qty.	Cat.No.
①	Diaphragm vacuum pump	–	1 pc	5010-50026
②	Suction Filtration Bottle 3 L	With a silicon plug and a hose connector set	1 set	5010-50028
—	Suction Filtration Bottle 1 L	With a silicon plug and a hose connector set	1 set	5010-50027
③	Vacuum Hose	2 m	1 pc	5010-50030
④	Hose Connector set	–	1 set	5010-50029
⑤	GL-SPE Concentration Tube	0.5 mL&1.0 mL/7 mL Clear Taper	10 pcs	5010-51013
⑥	GL-SPE Concentration Tube	Brown 0.5 mL · 1.0 mL/7 mL Clear Taper	10 pcs	5010-51014
⑦	Ls Tubing 6	with Cartridge Connection Adapter	6 pcs	5010-50212
⑧	Lure Stop Valve	PTFE	12 pc	5010-60010
⑨	SPE Cartridge Adaptor	for 1,3,6 mL (PP)	12 pc	5010-60000

Accessories for Vacuum Manifold



5010-50238



5010-50024

5010-50022



5010-60010



5010-50249



5010-50122



5010-50127

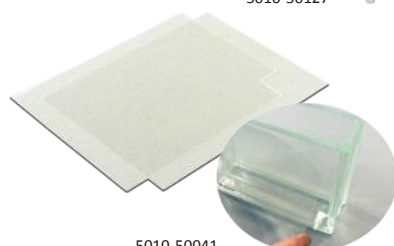

5010-50041

InertSep/GL-SPE Vacuum Manifold Accessories

No. *	Description	Specification	Qty.	Cat.No.
①	Glass Chamber	Suction Tube Connector 1 pc	1 pc	5010-50237
		For Inorganic Compounds Analysis	1 pc	5010-50243
②	Top Cover Assembly (PE)	For General Analysis	1 pc	5010-50238
		For Inorganic Compounds Analysis	1 pc	5010-50244
		Eggplant Flask 4 pcs	1 pc	5010-50247
		For 20 Samples	1 pc	5010-50254
③	Gasket	Polystyrene Foam	2 pcs	5010-50239
④	Vacuum Gauge	For General Analysis (Brass)	1 pc	5010-50014
		For Inorganic Compounds Analysis (Stainless Steel)	1 pc	5010-50123
⑤	Bleed Valve	For General Analysis (Brass)	1 pc	5010-50015
		For Inorganic Compounds Analysis (Stainless Steel)	1 pc	5010-50124
⑥	Plug	PP	12 pcs	5010-50016
⑦	Stainless Delivery Tip	Stainless Steel	12 pcs	5010-50019
		PTFE Delivery Tip	PTFE	12 pcs
—	12 mm Waste Funnel	PP	12 pcs	5010-50022
—	16 mm Waste Funnel	PP	12 pcs	5010-50024
⑧	Luer Fitting	PTFE	12 pcs	5010-50032
⑨	Vacuum Tube Connector	(PP, Fluoro Rubber)	1 pc	5010-50033
		For Inorganic Compounds Analysis (PP, Perfluor)	1 pc	5010-50125
⑩	Luer Stop Valve	PTFE	12 pcs	5010-60010
		Luer Flow Control Valve	PP	10 pcs

Accessories for InertSep Vacuum Manifold Kit

No. *	Description	Specification	Qty.	Cat.No.
⑪	Rack(PE)	12 mm/16 mm Test Tube, 7 mL Concentration Tube (for 12 Samples)	1 pc	5010-50240
		20 mL (for Test Tube with Funnel O.D. 22 mm, 12 Samples)	1 set	5010-50241
		30 mL (for Test Tube with Funnel O.D. 22 mm, 12 Samples)	1 set	5010-50242
		TS29/38 50 mL 4 pcs or 100 mL 2 pcs	1 pc	5010-50249
		Eggplant Flask	1 pc	5010-50246
		50 mL DigiTUBE for Inorganic Compounds Analysis/8 Samples	1 pc	5010-50246
		7 mL Concentration Tube, 16 mm Test Tube (for 20 Samples)	1 pc	5010-50256
20/30 mL Concentration Tube (for 20 Samples)	1 pc	5010-50253		
—	Waste Tray	Stainless Steel	1 pc	5010-50122
—	Drain Plate	For Inorganic Compounds Analysis (PP and POM:Legs)	1 pc	5010-50127
⑫	Glass Protection Film	Prevention of scattering when glass breaks (PE)	2 pcs	5010-50041
⑬	O-Ring	For fixing rack lower plate (FKM)	10 pcs	5010-50017
⑭	SUS Nut	For fixing rack upper plate (Stainless Steel)	4 pcs	5010-50018
⑮	Resin Clip	For fixing rack lower plate for Inorganic Compounds Analysis(FKM)	4 pcs	5010-50128
⑯	Resin Nut	For fixing rack upper plate for Inorganic Compounds Analysis (Stainless Steel)	4 pcs	5010-50129

* Refer in 64 page figure

InertSep Empty Reservoirs and Frits

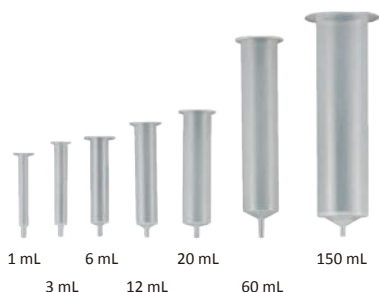

An empty reservoir made of PP. It is useful for pouring conditioning solutions into luer device–type or small-volume cartridges or for sample loading. When filling with a filler, use fritted.

Size

Volume	O.D. (mm)	I.D. (mm)	Length (mm)	Volume	O.D. (mm)	I.D. (mm)	Length (mm)
1 mL	7.7	5.7	66	20 mL	22.9	20.1	99
3 mL	10.9	8.9	75	60 mL	30	26.7	155
6 mL	14.7	12.8	78	150 mL	41	37.7	172
12 mL	18	15.7	90				

Volume	Without Flit		With 2 pcs Flits*	
	Qty.	Cat.No.	Qty.	Cat.No.
1 mL	50 pcs	5010-60100	50 pcs	5010-60120
3 mL	50 pcs	5010-60101	50 pcs	5010-60121
6 mL	30 pcs	5010-60102	30 pcs	5010-60122
12 mL	20 pcs	5010-60103	20 pcs	5010-60123
20 mL	20 pcs	5010-60104	20 pcs	5010-60124
60 mL	10 pcs	5010-60105	10 pcs	5010-60125
150 mL	10 pcs	5010-60106	10 pcs	5010-60126

*: One frit is attached to the reservoir, and one is included.

Description	Specification	Qty.	Cat.No.
Only Flit (PE)	For 1 mL	100 pcs	5010-60150
	For 3 mL	100 pcs	5010-60151
	For 6 mL	60 pcs	5010-60152
	For 12 mL	40 pcs	5010-60153
	For 20 mL	40 pcs	5010-60154
	For 60 mL	20 pcs	5010-60155
	For 150 mL	20 pcs	5010-60156

InertSep Cartridge Adaptors



It is attached to the top of a syringe–barrel type cartridge to connect an empty reservoir, and it is convenient for use when loading samples.

Description	Specification	Qty.	Cat.No.
InertSep Cartridge Adaptors (PP)	SPE Cartridge Adaptor for 1, 3, 6 mL (PP)	12 pcs	5010-60000
	SPE Cartridge Adaptor for 12,20 mL (PP)	12 pcs	5010-60001
	SPE Cartridge Adaptor for 60 mL (PP)	12 pcs	5010-60002
	SPE Cartridge LSC Adaptor (PP)	12 pcs	5010-60004
	SPE Cartridge Adaptor for 150 mL (PP)	1 pc	5010-50336

Reservoirs with Adaptor



An adapter for connecting a solid phase column and a reservoir are integrated into one unit. There is no need to connect the adapter and reservoir. The tapered connection allows for a firm connection to a solid phase column.

Description	Specification	Qty.	Cat.No.
25 mL Reservoir with Adaptor for 1, 3, 6 mL SPE Cartridges	PP	12 pcs	5010-60015
50 mL Reservoir with Adaptor for 12, 20 mL SPE Cartridges		12 pcs	5010-60016
200 mL Reservoir with Adaptor for 60 mL SPE Cartridges		12 pcs	5010-60017

Luer Stop Valve



The flow rate can be adjusted simply by connecting the solid phase column to the manifold and opening/closing a valve. The material is made of PTFE and has excellent solvent resistance.

Description	Specification	Qty.	Cat.No.
Luer Stop Valve	PTFE	12 pcs	5010-60010

Waste Container for Vacuum Manifold



5010-50122



5010-50127

It is placed in a glass chamber and used to collect the effluent that has passed through the solid phase column.

Description	Specification	Qty.	Cat.No.
Waste Tray	Stainless Steel	1 pc	5010-50122
Drain Plate	PP and POM: Legs (for Inorganic Compounds Analysis)	1 pc	5010-50127

Useful Items for Vacuum Manifold



The sealing plug has the same luer-tip shape as the tip of the solid phase column. It can plug ports that are not in use, such as suction manifolds.

Description	Specification	Qty.	Cat.No.
Sealing Plug	PP	12 pcs	5010-50016

Note: Twelve plugs are included with the InertoSep Suction Manifold Kit and system.

LS Tubing

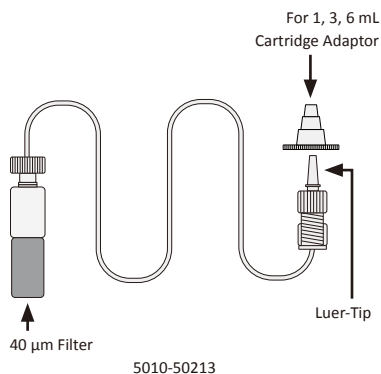

A tube with a 40-µm pore-size filter and lure tip type adapter. It prevents debris and dirt from flowing into the solid phase column when a large-volume of sample water is passed through.

(If the SS component is particularly high, prefiltration is recommended before use, if necessary.)

The length of the tube is ~1 m.

LS Tubing 1, 6, and 12 come with cartridge adapters (for 1, 3, and 6 mL).

Description	Specification	Qty.	Cat.No.
LS Tubing 0	without Cartridge Connection Adapter	1 pc	5010-50214
LS Tubing 1	with Cartridge Connection Adapter 1 pc	1 pc	5010-50213
LS Tubing 6	with Cartridge Connection Adapter 6 pcs	6 pcs	5010-50212
LS Tubing 12	with Cartridge Connection Adapter 12 pcs	12 pcs	5010-50211

GL-SPE Concentration tubes/Test tubes

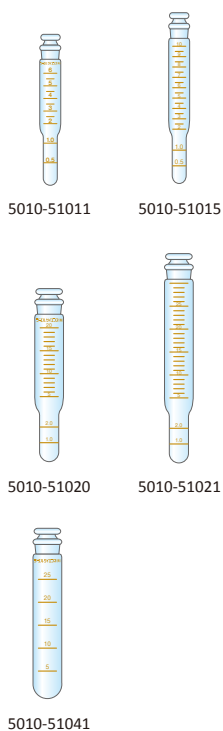

GL-SPE Concentration Tubes are collection tubes used to collect eluted solutions from solid phase columns. Some of the concentration tubes and test tubes are equipped with a scalpel scale so that the collected eluate can be concentrated or volume-constituted by adding a solvent without transferring the eluate to another test tube or other container.

Description	Color	Scale (Volume) mL	O.D. mm	Scale (Max. Volume) mL	Plug	Qty.	Cat.No.
Co-Stoppered Graduated Tube	Clear	—	12	6(6.5)	Co-Stoppered	20 pcs	5010-51001
Spitz Tube 12 mm	Clear	—	16	14(15)		20 pcs	5010-51002
Co-Stoppered Graduated Tube	Clear	1.0 mL		6(7)	Tapered	10 pcs	5010-51010
Spitz Tube 16 mm						10 pcs	5010-51011
GL-SPE Concentration Tube	Amber	0.5&1.0 mL			10(10.5)	10 pcs	5010-51012
	Clear					10 pcs	5010-51013
	Amber				Co-Stoppered	10 pcs	5010-51014
	Clear					10 pcs	5010-51015
	Amber			10 pcs		5010-51016	
	Clear			1.0&2.0&5.0 mL		5(6) ^{*1}	10 pcs
GL-SPE Test Tubes	Clear	1.0&2.0 mL		22	20(20.5)	Co-Stoppered	6 pcs
	Clear	1.0&2.0 mL	30(30)		6 pcs		5010-51021
	Clear	5.0 mL	16.5	5(16)	Tapered	10 pcs	5010-51040
	Clear	5.0&10 mL		10(16)		10 pcs	5010-51039
	Amber	5.0 mL		5(9)		10 pcs	5010-51042
	Clear	—	22	25 ^{*2}	—	6 pcs	5010-51041

1: Scaled to 0.1 and 0.2 mL.

2: Scaled to 5 mL.

Note: Scales other than the female scale and the spitz tube scale indicate approximate amounts.

Racks



5010-50034

(Concentration tube not included)

Racks are available to match the shape of the eluate receiver (This is for both the InertSEP suction manifold and the GL-SPE suction manifold).

Description	Specification	Diameter	Qty.	Cat.No.
Rack (PE)	12 mm/16 mm Test Tube (for 12 Samples)	12.5 mm/17 mm	1 pc	5010-50240
	20 mL Concentration Tube with Funnel (for 12 Samples)	φ23 (For Funnel φ13m)	1 set	5010-50241
	30 mL Test Tube with Funnel (for 12 Samples)		1 set	5010-50242
	TS29/38 50 mL 4 pcs or 100 mL 2 pcs Eggplant Flask	32 mm (30 mm)	1 pc	5010-50249
	For 50 mL DidiTUBEs (for Inorganic Compounds Analysis,8 Samples)	31 mm	1 pc	5010-50246
	7 mL Concentration Tube, 16 mm Test Tube (for 20 Samples)	17 mm	1 pc	5010-50256
	20/30 mL Concentration Tube (for 20 Samples)	23 mm	1 pc	5010-50253

Adapters for Backflush

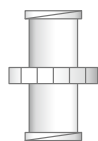

5010-52013

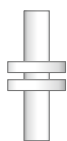

5010-52012



5010-52011 example

The back-flush adapter is used when eluting solid phase columns from the opposite direction of the flow direction.

Description	Specification	Qty.	Cat.No.
Male Luer Union for Backflush	Luer Tip Male on both Sides (PP)	10 pcs	5010-52012
Female Luer Union for Backflush	Luer Tip Female on both Sides (PP)	10 pcs	5010-52013
Backflush Adaptor for SPE Cartridge	Luer Tip Female on both Sides (PTFE)	5 pcs	5010-52011

GL-SPE Gravity Flow Manifold



5010-50430

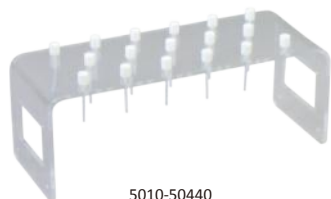

5010-50440

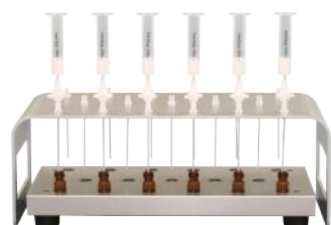

5010-50430 + 5010-50432
Combination Example

The GL-SPE natural drop manifold is optimized for solid phase extraction using the natural drop method. Twenty-four delivery tips are included.

- Simple design
- Optimal performance for Mycotoxins sample preparation
- Gravity flow is improved with the delivery tips
- Luer stop valve offers the adjustment of flow rate
- Optional extension panels for 4 mL Vials, GL-SPE concentration tubes and eggplant flasks are available

Description	Specification	Qty.	Cat.No.
GL-SPE Gravity Flow Manifold	For General Analysis (Aluminum)	1 set	5010-50430
	For Inorganic Compounds Analysis (PVC)	1 set	5010-50440

Accessories for Gravity Flow Manifold

Description	Specification	Qty.	Cat.No.
Extension Panel (Adjusting Height)	For General Analysis (Aluminum)	2 pcs	5010-50431
	For Inorganic Compounds Analysis (PVC)	2 pcs	5010-50441
Delivery Tips	For Gravity Flow(PP)	24 pcs	5010-50420
		100 pcs	5010-50421
Luer Stop Valve	PTFE	12 pcs	5010-60010
Tray (Aluminum)	For 4 mL Vials	1 pc	5010-50432
	For 20 mL Concentration Tubes	1 pc	5010-50433
	For 200/300 mL Eggplant-Shaped Flask	1 pc	5010-50434

GL-SPE Gravity Flow Rack



This rack is used to perform solid phase extraction operations by natural drop, such as InertSep K-solute. By adjusting the height of the stand, the receiver size and stand can be selected and set. Twelve samples can be processed simultaneously.

Description	Specification	Qty.	Cat.No.
GL-SPE Gravity Flow Rack Basic Unit	Stainless Steel	1 set	5010-50410

The basic unit does not include a stand for the receiver.

Accessories for GL-SPE Gravity Flow Rack

Description	Specification	Qty.	Cat.No.
Gravity Flow Collection Stand (Stainless Steel)	For 50/100 mL Eggplant-Shaped Flask	1 pc	5010-50422
	For 200/300 mL Eggplant-Shaped Flask	1 pc	5010-50423
	For 20/30 mL Concentration Tubes	1 pc	5010-50424
	For 50 mL Centrifuge Tube	1 pc	5010-50425
Delivery Tip	For GL-SPE Gravity Flow	24 pcs	5010-50420
		100 pcs	5010-50421
Luer Stop Valve	PTFE	12 pcs	5010-60010

For InertSep mini AERO DNPH

GL-SPE Manifold 20 for InertSep mini AERO DNPH



The InertSep Elution Manifold 20 is an InertSep mini AERO DNPH elution-only manifold. A flow-controlled (approximately 1 mL/min) spontaneous drop enables the efficient elution of up to 20 samples in DNPH cartridges after aldehyde collection.

No pumping equipment is required for elution.

It is capable of natural drop treatment at a flow rate of approx. 1 mL/min*.

It can reduce manual elution labor.

*: To perform elution by spontaneous drop, a 5 mL DNPH elution syringe is separately required. It is also extracted in the range of 0.6–1.2 mL/min when acetonitrile solvent is used (Flow rate cannot be changed).

Description	Specification	Qty.	Cat.No.
InertSep Manifold 20	For InertSep mini AERO DNPH (20 Samples)	1 set	5010-50236

Accessories for InertSep Manifold 20

Description	Specification	Qty.	Cat.No.
Top Cover Assembly	–	1 pc	5010-50251
Delivery Tip	PTFE	20 pcs	5010-50134
Gasket	For 20 Samples (For InertSep Vaccume Manifold)	2 pcs	5010-50252
7 mL Rack for Concentration Tubes and Test Tubes	For 20 Samples	1 pc	5010-50256

Note: Gaskets cannot be used in the common process.

Option for InertSep Manifold 20

Description	Specification	Qty.	Cat.No.
Syringe for DNPH Elution	5 mL Glass(without needle)	6 pcs	3008-41151

GL-SPE mini Vacuum Manifold

2

Accessories for SPE



GL-SPE mini Vacuum Manifold

GL-SPE mini vacuum manifold kit is space-saving, and kit 12C for cartridges and kit 96W for 96-well plates are available. Kit 12C can be used with SPE cartridge of up to 6 mL. As its option, vials can be placed.

● Features

- Two types for cartridges or 96-well plates
- Space-saving
- Concentration tubes, 7 mL test tubes and tubes with 16 mm O.D. x 100 mm length are placeable as connection tubes.

Description	Format	Qty.	Cat.No.
GL-SPE Mini Vacuum Manifold Kit 12C (12 place positions for SPE cartridges)	Cartridge	1 pc	5010-50150
GL-SPE Mini Vacuum Manifold Kit 96W	96-well plate	1 pc	5010-50155
Vacuum Controller	Common	1 pc	5010-33071

Note: GL-SPE mini manifold kit 12C and 96W don't include the vacuum controller.

Accessories for GL-SPE Mini Manifold

Description	Qty.	Cat.No.
GL-SPE Mini Vacuum Manifold Chamber for 12C	1 pc	5010-50160
GL-SPE Mini Vacuum Manifold Top Plate for 12C * ¹	1 pc	5010-50161
GL-SPE Mini Vacuum Manifold Concentration Rack for 12C	1 pc	5010-50162
GL-SPE Mini Vacuum Manifold Delivery Tip for 12C	15 pcs	5010-50163
GL-SPE Mini Vacuum Manifold Chamber for 96W	1 pc	5010-50165
GL-SPE Mini Vacuum Manifold Base Unit (Common)	1 pc	5010-50166
GL-SPE Mini Vacuum Manifold Drain Plate (Common)	1 pc	5010-50167
GL-SPE Mini Vacuum Manifold Shim Set 1 t x 2 pcs, 2 t x 1 pc for 96W	1 set	5010-50168
GL-SPE Mini Vacuum Manifold Gasket Set * ² (Common)	1 set	5010-50169

*1 : Top Plate doesn't include delivery tip.

*2 : Gasket set contains a gasket for top side and a gasket for bottom side.

Eggplant-Shaped Flasks



A transparent sliding eggplant flask is used to collect the eluted liquid from the solid phase column. The sliding part is TS29/38.

Description	Volume	Qty.	Cat.No.
TS29/38	50 mL	2 pcs	5010-51031
	100 mL	2 pcs	5010-51032
	200 mL	2 pcs	5010-51033*

* : 200 mL eggplant flasks cannot be used with the inertosep aspiration manifold.

Connector Tubings

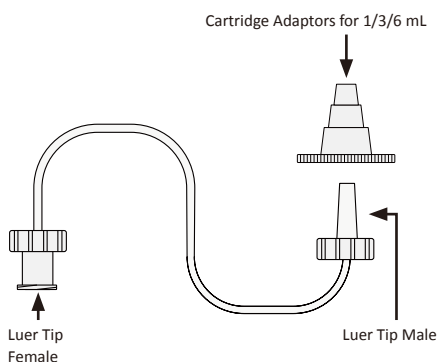

A 30-cm tube with lure tip male on one side and lure tip female on the other. One InertSep cartridge adapter (for 1, 3, and 6 mL) is included per bottle.

Description	Specification	Qty.	Cat.No.
Connector Tubings	PTFE Tubing 30 cm	1 pc	5010-52021
		5 pcs	5010-52022

Cap for SPE Columns



Male luer cap

Female luer cap

It can be used as an inlet/outlet plug for luer device-type solid phase columns or as an unused plug for luer connections.

Description	Specification	Qty.	Cat.No.
Male luer cap	PP	50 pcs	5010-52015
Female luer cap		50 pcs	5010-52016

Plastic Disposable Syringe



A low-blank disposable syringe made of highly inert polypropylene. It can be used for filtration treatment prior to analysis. In addition, the Luer-lock type connection makes it easy to connect to a syringe.

Description	Volume	Qty.(pcs)	Cat.No.
Plastic Disposable Syringe	2 mL	100	1030-55102
	5 mL	100	1030-55105
	10 mL	100	1030-55110
	20 mL	100	1030-55120

GL Filter



Impurity particle removal filter for HPLC.

PTFE (hydrophobic and hydrophilic), Nylon, and PES are available as filter materials.

2

Accessories for SPE

Chemical resistance list

○ : Available, △ : Available for a short time, × : Disavailable, — : No Data

PTFE: Polytetrafluoroethylene
PES: Polyethersulfone

	Filter Diameter	Pore size	PTFE Hydrophilic	PTFE Hydrophobic	Nylon	PES
Cat.No. Ring Color	13 mm	0.22 μm	5040-29005 (GL0606)	5040-29009 (GL0610)	5040-29001 (GL0602)	5040-29013 (GL0622)
		0.45 μm	5040-29006 (GL0607)	5040-29010 (GL0611)	5040-29002 (GL0603)	5040-29014 (GL0623)
	25 mm	0.22 μm	5040-29007 (GL0608)	5040-29011 (GL0612)	5040-29003 (GL0604)	5040-29015 (GL0624)
		0.45 μm	5040-29008 (GL0609)	5040-29012 (GL0613)	5040-29004 (GL0605)	5040-29016 (GL0625)
ACIDS	Acetic acid 25		○	○	○	○
	Hydrochloric acid 25%		○	○	×	○
	Sulfuric acid 25%		○	○	×	○
	Nitric acid 25%		○	○	×	○
	Phosphoric acid 25%		○	○	×	—
	Formic acid 25%		○	○	×	—
Alcohol	Trichloroacetic acid 10%		○	○	×	—
	Methyl alcohol 98%		○	○	○	○
	Ethyl alcohol 70%		○	○	△	○
	Isopropyl alcohol		○	○	○	○
	Butanol		○	○	○	○
	Benzyl alcohol		○	○	○	—
Others	Glycerinum		○	○	○	○
	Triethanolamine		○	○	○	—
	Aniline		○	○	—	—
	Pyridine		○	○	○	×
	Acetonitrile		○	○	○	△
	Ethyl acetate		○	○	○	×
	N-butyl acetate		○	○	○	×
	Propyl acetate		○	○	○	×
	Cellosolve acetate		○	○	—	×
	Methyl Cellosolve		○	○	—	×
	Isopropyl myristate		○	○	○	×
	Acetone		○	○	○	×
	Cyclohexanone		○	○	○	×
	Methyl ethyl ketone		○	○	○	×
	Methyl-Isobutyl Ketone		○	○	—	×
	Dioxane		○	○	○	×
	Tetrahydrofuran		○	○	○	×
	Dimethyl sulfoxide		○	○	○	×
	Isopropyl ether		○	○	—	○
	Phenol solution 10%		○	○	—	×
Formaldehyde Solution 30%		○	○	○	○	
Hydrogen Peroxide		○	○	○	—	
Silicone oil/silicone oil		○	○	—	○	

- The data in this table are reference values.
- Please try a small amount of sample in advance to confirm its safety before conducting the main experiment.

3. Products Related Life Sciences Analysis

● Filter Plate	78
● Monolith Silica	80
● MonoSpin	81
● SPE Tip Columns for Trace Samples	85
● Exosome	86
● MonoSpin ProA, MonoSpin ProG, MonoSpin ProL	88
● Phosphorylation Purification & Enrichment	90
● Tip Columns for Enrichment of Phosphopeptides	93
● Desalting and Enrichment Phosphopeptide/ Fractionation Tips	94

FastRemover Series

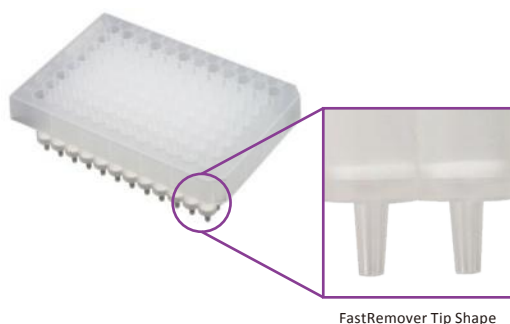

This 96-well filter plate uses a low adsorption filter and a housing with low elution of plasticizers and other substances. Serum and plasma samples can be processed easily and reliably.

- Can be used for high-sensitivity analysis due to a low blank to use pellets that have undergone a dissolution test.
- The tip has a long nozzle shape, which enables small-volume elution and prevents cross-contamination between wells.
- Can be used for processing with automated equipment due to its structure with excellent liquid permeability without clog error.

Filter Plate FastRemover MF

The UHPLC apparatus, which has been widely used in recent years, has a low pipe inner diameter to reduce dead volume, and it is said to have a high risk of system and column clogging because of particulate contamination. Therefore, it is recommended that the measurement sample also be passed through a 0.2- μm filter. However, conventional filter plates have a short nozzle, which causes the sample to splash, and there is concern about contamination of other wells. The FastRemover MF has a long nozzle that enters each well, allowing the sample to be filtered with minimal risk of contamination.

LC/MS Analysis Result of Post-Filtration Eluate

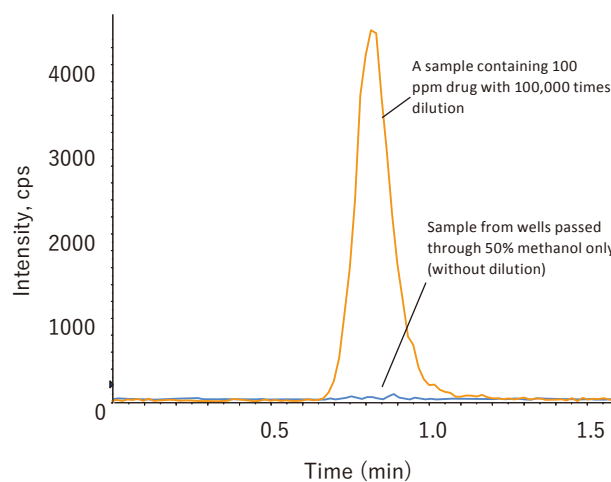

Filter Plate for Deproteinization FastRemover for Protein

The deproteinization method requires a significant amount of time and effort when processing multiple samples. In processing with FastRemover for Protein, the sample is easily recovered by the pass-through filtration of the protein-denatured sample using an organic solvent and aspiration. FastRemover for Protein uses polypropylene pellets, which have low plasticizer elution, and the membrane is molded from PTFE, which exhibits a low adsorption capacity, into a multilayer membrane. Thus, it can be used with any denaturing agent, from methanol to acetonitrile.

Filter Plate for Phospholipids/Pro

Biological samples, such as blood, contain phospholipids. In LC/mass spectrometry (MS) (/mass spectrometry (MS)) analysis, these phospholipids may suppress the ionization of the target substance.

FastRemover for phospholipids removes more than 90% of phospholipids for more accurate analysis.



Specification

Description	Specification
Pore Size	0.2 μm
Max. Throughput Volume	1.0 mL
Recommended Solvent	0.1 to 1% Formic Acid-Acetonitrile Solution 1:4 or 1:3 (Biological sample:Solvent)
Max. Sample Capacity	150 μL (Serum)

Fast Remover Series Specification

Description	Specification
Material of Filter	PP, PE, PTFE
Pore Size	0.2 μm or 0.45 μm
Material of Housing	PP
Number	96
Volume	1 mL
Sterility	Non-Sterile



Lineup

Description	Pore Size	Qty.	Cat.No.
FastRemover MF	0.2 μm	50 pcs	7510-11037
FastRemover for Protein	0.45 μm	1 pc	7820-11001
		5 pcs	7820-11005
	0.2 μm	1 pc	7820-11011
		5 pcs	7820-11015
FastRemover for Phospholipid	0.2 μm	1 pc	7510-11021

Monolith Silica ~ New separation media that are neither particulate nor membrane ~

Silica monoliths are integral silica gels with uniform continuous pores and produced from ethyl silicate. Unlike the particle media, the silica monolith is shaped like a disk. Silica monoliths have high liquid permeability and large surface area as they have through pores and mesopores on their framework surface. Thus, this state of the art medium is becoming popular worldwide for its properties: high recovery, high performance of adsorption, and desorption.

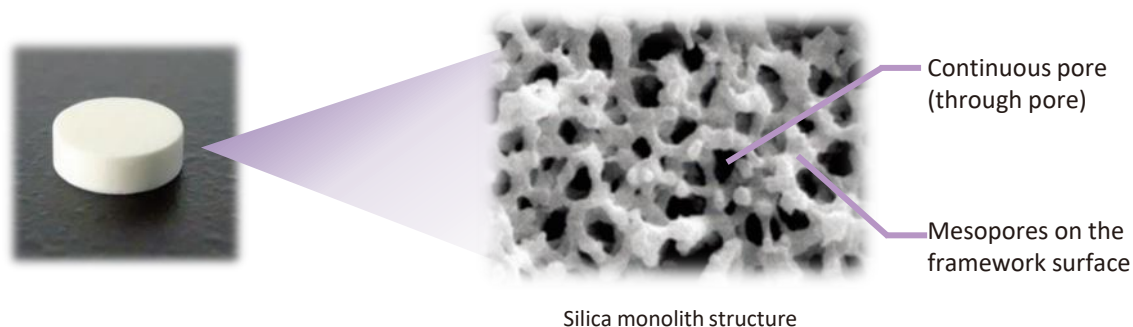

Advantages of Monolithic SPE materials over particle packed SPE materials

- Disk-shaped silica monoliths do not use frits to hold particle media in traditional solid phase extraction cartridges.
- Monolithic material has a massive surface area, making it possible to reduce the sample volume. Silica monoliths makes it possible to retain samples in the cartridge and completely elute small samples during processing.
- Despite its high liquid permeability, it is also suitable for fast elution without losing its high recovery as it achieves rapid sample diffusion and separation.

Silica monolith

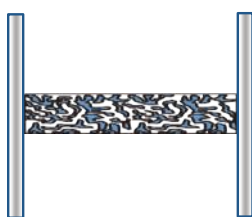

- No filter required
- Minimized separation media

Bed volume for separation media : **small**

Sample diffusion in the column : **fast**

Separation speed : **fast**

Particle-filled Form

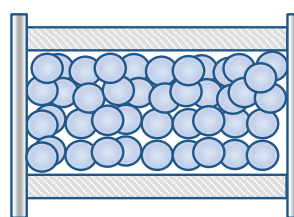

- Need for filters
→ liquid may be remained in the filter

Bed volume for separation media : **large**

Sample diffusion in the column : **slow**

Separation speed : **slow**

MonoSpin series

MonoSpin is a solid-phase extraction spin column that uses silica monoliths with uniform continuum pores. It effectively and rapidly extracts, isolates, purifies, and concentrates samples by centrifugation.

【Features】

- Easy operation by centrifuge
- Speedy sample treatment with a superb through the pore
- Excellent reproducibility (S-type) even at 100 μ L or fewer elution volumes.

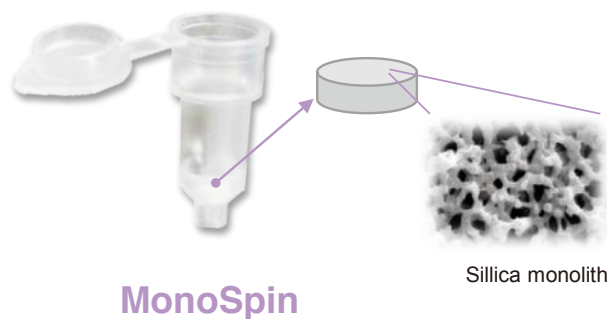

Operation method

Short time centrifugation is used to pass the liquid in solid-phase extraction.

The whole sample treatment process can be done within 10 min.

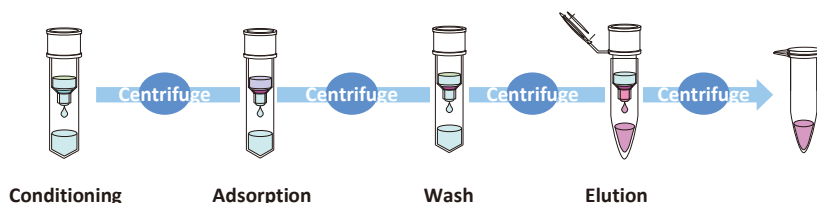

Centrifuge Operation

Shape

MonoSpin series cartridges of different types are available:

Type S: Excellent for pretreating the sample for 50–800 μ L

Type L: Appropriate for sample 0.5–8 mL.

For the details of the varied functional group, please see the next page.



S Type

- Disk size : 4.2 × 1.5 mm
- Sample volume : up to 800 μ L
- Elution volume : 50 to 800 μ L
- Centrifugation speed : 2,000 to 10,000 × g



L Type

- Disk size : 9 × 3 mm
- Sample volume : up to 8 mL
- Elution volume : 0.5 to 8 mL
- Centrifugation speed : 1,000 × g

NOTE) MonoSpin ProA and MonoSpin ProG have different shapes. Please see page 88 for details.

96 Well plate type

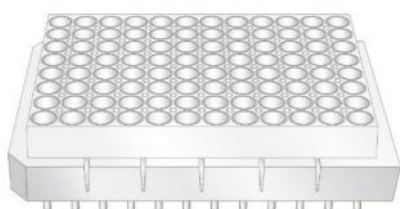

- Sample volume : up to 800 μ L
- Elution volume : 50 to 800 μ L
- Centrifugation speed : 1,000 to 5,000 × g (can be used in vacuum aspiration)

NOTE) MonoSpin C18 FF, MonoSpin ProA and MonoSpin ProG have different specifications. Please see page 82 and 83 for details.

MonoSpin series lineup

MonoSpin C18/C18 FF

S L 96

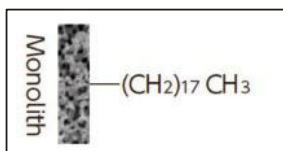

Octadecyl functional group. Optimal for drug extraction in biological samples and desalting and enrichment of peptide samples. High-flow (FF) designs are also available.

MonoSpin C18-AX

S 96

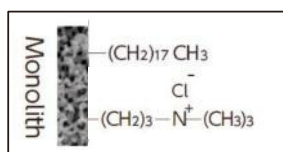

It is a mix mode type in which both octadecyl and quaternary ammonium groups are chemically bonded. It can reliably retain bio-samples at high salt concentrations and is particularly suitable for the recovery of acidic drugs.

MonoSpin SAX

S L 96

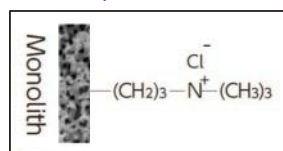

Bond with Trimethyl aminopropyl, combining strong anion exchange and weak hydrophobic interaction. It is best for extracting acidic drugs.

MonoSpin NH2

S L 96

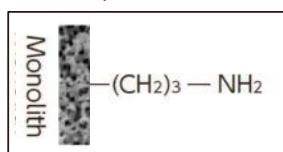

It is bonded with aminopropyl and is beneficial for enriching the sugar chain or hydrophilic compounds by HILIC mode.

MonoSpin Amide

S 96

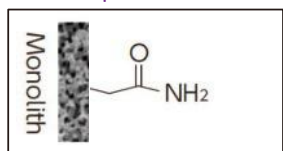

It is bonded with an amide group. MonoSpin amide is best for extracting sugar chains and various acidic and basic hydrophilic compounds by HILIC mode.

MonoSpin TiO

S

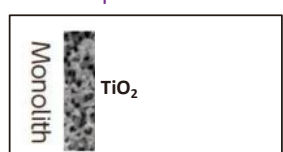

It is characterized by a monolith skeleton coated with dioxide titanium. It is excellent for enriching phosphopeptides.

MonoSpin ME

S L

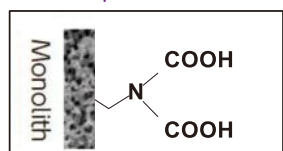

It is bonded with iminodiacetic acid groups. Therefore, it is optimal for the recovery of trace metals in samples.

MonoSpin ProA, ProG, ProL

S L 96

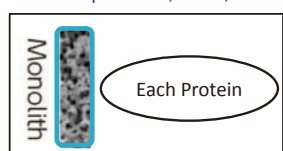

They are affinity carriers on which each protein is immobilized. Antibodies can be purified quickly. MonoSpin ProL is S type only. The shape of the L-shaped column is a syringe barrel type.

MonoSpin Ph

S

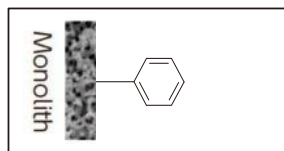

The phenyl group is chemically bonded, which makes it feasible to use weaker hydrophobicity than C18. Therefore, it is suitable for the recovery of hydrophobic drugs from biological samples under reversed phase mode.

MonoSpin C18-CX

S 96

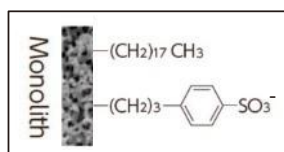

Its octadecyl and benzenesulfonic acid groups are bonded. Thus, purifying dissociated basic drugs in serum and urine is appropriate. Compared with MonoSpin C18 and SCX alone, SCX has higher cleanup efficacy as it works as hydrophobic and ion-exchange interactions.

MonoSpin SCX

S L 96

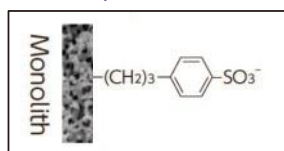

It is bonded with propyl benzene sulfonic acid, combining strong cation exchange and hydrophobic interaction. Therefore, MonoSpin SCX is excellent for extracting basic drugs.

MonoSpin CBA

S L 96

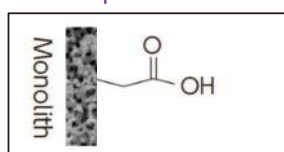

It is bonded with propyl benzene sulfonic acid, combining strong cation exchange and hydrophobic interaction. It is excellent for extracting basic drugs.

MonoSpin PBA

S 96

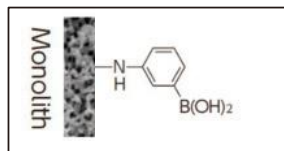

It is bonded with phenyl boric acid, which gives you higher selectivity. Hence, MonoSpin PBA is excellent for extracting cis diol compounds, such as catechol amines.

MonoSpin Trypsin

S



The columns are immobilized with trypsin, a digestive protein enzyme. It enables the rapid digestion of proteins.

MonoSpin Phospholipid

S L

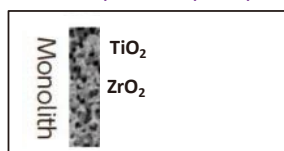

It has a phospholipid removal column coated with titanium dioxide and zirconium dioxide on a silica monolith. It adsorbed phospholipids in samples with an easy pretreatment.

MonoSpin AG

S L 96

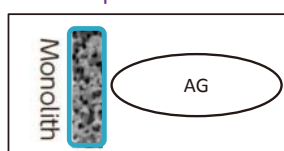

It is a column that combines octadecyl groups and cation exchange groups. Hydrophobic interaction and ion exchange action work.

S : S-type column products L : L-type column products 96 : 96-well plate-type product

Order Information

MonoSpin type S

Description	Qty.(pcs)	Cat.No.
MonoSpin C18	50	5010-21700
	100	5010-21701
MonoSpin C18 FF	50	5010-21670
	100	5010-21671
MonoSpin Ph	50	5010-21733
	100	5010-21734
MonoSpin C18-AX	50	5010-21735
	100	5010-21736
MonoSpin C18-CX	50	5010-21731
	100	5010-21732
MonoSpin SAX	50	5010-21720
	100	5010-21721
MonoSpin SCX	50	5010-21725
	100	5010-21726
MonoSpin NH2	50	5010-21710
	100	5010-21711
MonoSpin CBA	50	5010-21729
	100	5010-21730
MonoSpin Amide	50	5010-21727
	100	5010-21728
MonoSpin PBA	50	5010-21715
	100	5010-21716
MonoSpin TiO	50	5010-21705
	100	5010-21706
MonoSpin Trypsin HP	30	7510-11302
MonoSpin ME	50	5010-21737
	100	5010-21738
MonoSpin Phospholipid	50	5010-21698
	100	5010-21699
MonoSpin AG	50	5010-21696
	100	5010-21697



MonoSpin Type S

Recovery tube
(1.7 mL)Liquid waste tube
(2 mL)

MonoSpin type S Trial kit

Trial and custom kits are shipped with various columns packaged for initial method development.

Description	Content	Cat.No.
MonoSpin Trial Kit 1	C18, TiO, SCX, SAX 10 each	5010-21740
MonoSpin Trial Kit 2	C18, Amide, CBA, NH2 10 each	5010-21741
MonoSpin Trial Kit 3	SCX, SAX, CBA, NH2 10 each	5010-21742

MonoSpin type L

Description	Qty.(pcs)	Cat.No.
MonoSpin L C18	30	7510-11320
MonoSpin L SAX	30	7510-11321
MonoSpin L SCX	30	7510-11322
MonoSpin L NH2	30	7510-11323
MonoSpin L CBA	30	7510-11324
MonoSpin L ME	30	7510-11325
MonoSpin L Phospholipid	30	7510-11326



MonoSpin type L

MonoSpin 96 well plate

Description	Qty.(pcs)	Cat.No.
MonoSpin 96WP C18	1	5010-21900
MonoSpin 96WP NH2	1	5010-21901
MonoSpin 96WP PBA	1	5010-21902
MonoSpin 96WP SAX	1	5010-21903
MonoSpin 96WP SCX	1	5010-21904
MonoSpin 96WP Amide	1	5010-21905
MonoSpin 96WP CBA	1	5010-21906
MonoSpin 96WP C18-CX	1	5010-21907
MonoSpin 96WP C18-AX	1	5010-21908

SPE Tip Columns for Trace Samples

MonoTip C18



MonoTip C18

MonoTip C18

MonoTip C18 is a pretreatment tip consisting of octadecyl groups bonded to silica monoliths with uniform continuous pores. Simple pipetting allows for the desalting and concentration of proteins and peptides in reversed-phase mode.

High purification efficiency, large loadings, good reproducibility.

With conventional tips that use particle fillers, it is difficult to keep the particle space constant, resulting in poor reproducibility and low recovery rates. However, by exploiting the monolith with uniform continuous pores, a high purification efficiency, large sample loadings, and good reproducibility can be achieved.

Effective sample concentration

Sample: β -casein trypsin digestible (0.1 mg/mL)

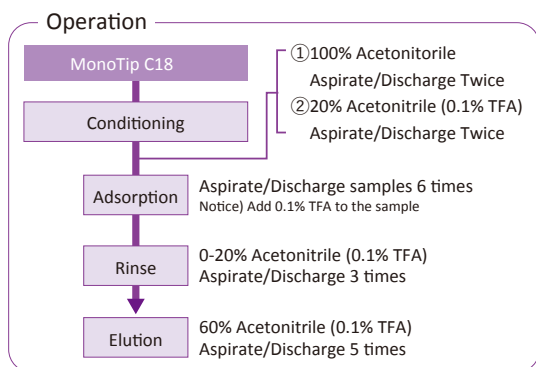

Condition

Column : Inertsil WP300 C18 (150 X 2.1 mm I.D.)
 Eluent : A: H₂O (0.1 %TFA)
 B: CH₃CN/H₂O=90/10 (0.1 %TFA)
 A/B = 90/10-20 min-40/60
 Flow rate : 0.3 mL/min
 Detection : UV210 nm
 Injection Vol. : 5 μ L

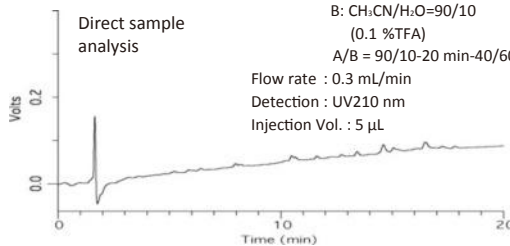

Preparation with MonoTip C18

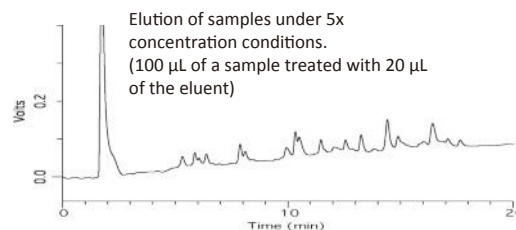

Purifications of antihistamine in serum

- "Simultaneous determination of ten antihistamine drugs in human plasma using pipette tip solid-phase extraction and gas chromatography/mass spectrometry." Hasegawa C et al., *Rapid Commun. Mass Spectrom* (2006);20: 537-543
- "Rapid demonstration of diversity of sulfatide molecular species from biological materials by MALDI-TOF/MS" Kyogashima M et al., *Glycobiology* (2006); 16(8),719-728
- "Simultaneous determination of methamphetamine and amphetamine in human urine using pipette tip solid-phase extraction and gas chromatography/mass spectrometry." Kumazawa T. et al. *J Pharm Biomed Anal.* 2007 Jan 8;
- "Establishment of a quantitative, qualitative, and high-throughput analysis of sulfatides from small amounts of sera by matrix-assisted laser desorption ionization-time of flight mass spectrometry." Li G et al. *Anal Biochem.* 2007 Mar 1;362(1):1-7

Description	Volume	Qty.(pcs)	Cat.No.
MonoTip C18	200 μ L	24	5010-21002
		96	5010-21000

Note: MonoTip C18 is a product based on patent-registered technology.

EVSecond

Exosome Purification Columns

Recent studies have reported significant roles of extracellular vesicle “Exosome” in development and progression of various diseases including cancer metastasis. Therefore, exosomes are considered as important targets for biomarkers and drugs. However, it remains difficult to isolate high-purity exosomes from biological fluids such as serum. EVSecond is a size exclusion chromatography open column optimized for effective purification of exosomes. Highly-purified exosomes can be easily collected from serum, plasma, or cell culture supernatant.

Features

- Simple gravity-flow handling without ultracentrifugation.
- EVSecond-purified exosomes possess efficient purity for comprehensive miRNA, proteome, and metabolome analysis.
- Exosomes are gently eluted in PBS without structural damage, allowing re-administration experiments of collected exosomes to cells or animals.

Advantages Over Traditional Procedures

- Much higher-purity exosomes can be obtained compared to ultracentrifugation or polymer precipitation methods.
- Unlike immuno-affinity purification using anti-tetraspanin antibodies, whole exosomes can be collected regardless of surface antigen profiles.

Typical Protocol using EVSecond

Gravity-flow is applied to each step.

1. Set columns on GL-SPE EXO fraction rack after mixing beads gently and thoroughly.



2. Block beads with 0.22 µm filter-purified FBS.



3. Equilibrate columns with PBS.



4. Load 50-700 µL 0.22 µm filter-purified samples (serum, plasma, or cell culture supernatant).



5. Load PBS and collect appropriate fractions including exosomes.

* Exosome-containing fractions can be identified by western blotting or ELISA experiments detecting tetraspanins (CD9, CD63, CD81, etc.)

GL-SPE EXO Fraction Rack

Open column rack optimized for EVSecond.
It helps smooth column handling and fractionation.

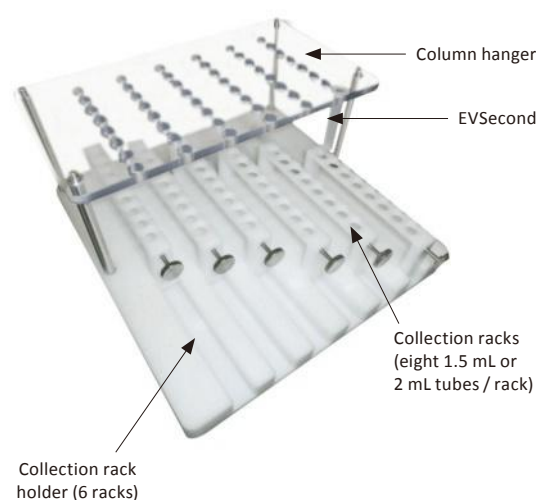

Dimensions : 300 (W) x 300 (D) x 150 (H) mm

Purification of Exosomes from Human Serum

A large amount of free proteins, metabolites, and nucleotides are involved in serum samples. Insufficient purification of exosomes often causes co-detection of non-exosomal components, leading to incorrect quantification results in omics studies. Exosomes were isolated from 100, 200, 300, or 700 μL of human serum using EVSecond method. Exosomes were clearly separated from serum free proteins such as albumin or immunoglobulins.

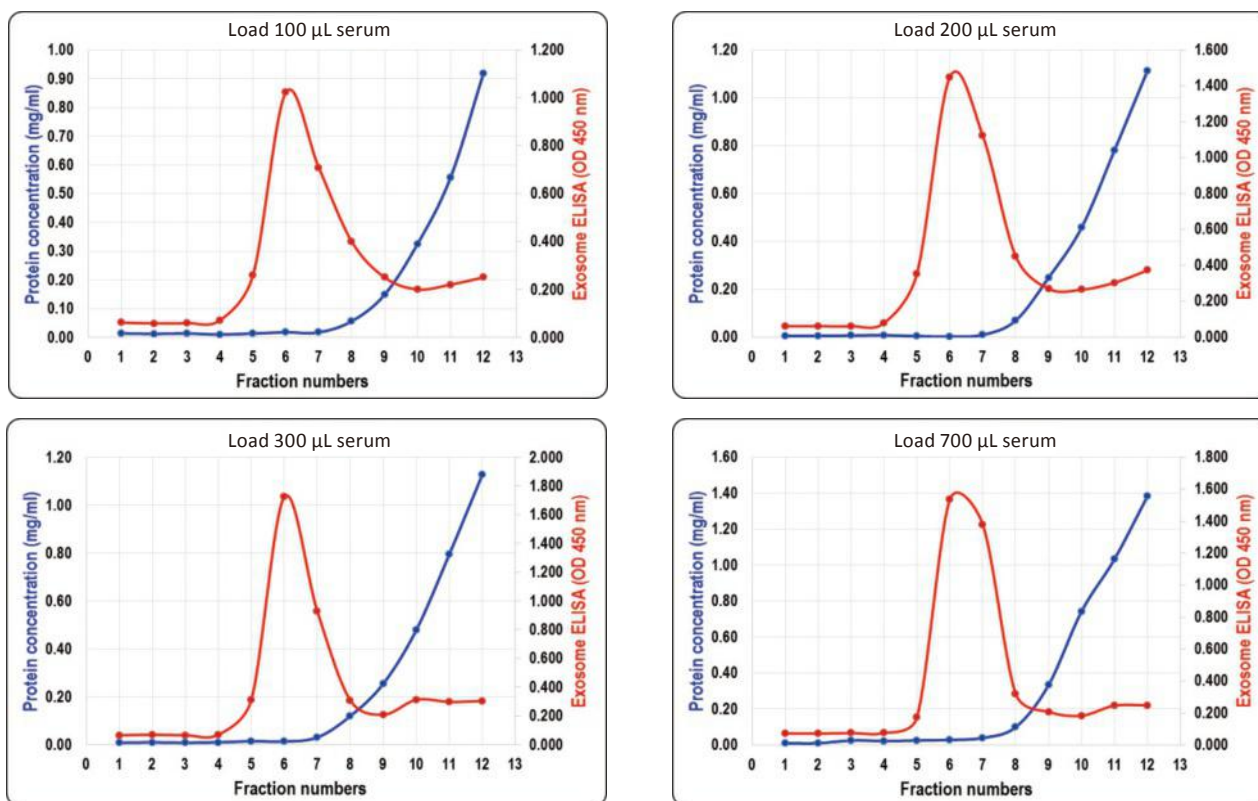

(100 μL / fraction)

Red line : CD9-CD9 exosome sandwich ELISA (detecting exosomes)

Blue line : Bradford assay (detecting serum free proteins)

Data provided by Dr. Koji Ueda from Graduate School of Frontier Sciences, The University of Tokyo

EVSecond

Description	Qty.	Cat.No.
EVSecond L70	10 pcs	5010-21395
GL-SPE EXO Fraction Rack	1 set	5010-50450

EVSecond was developed based on the cooperation from Dr. Koji Ueda from Graduate School of Frontier Sciences, The University of Tokyo.

MonoSpin ProA, MonoSpin ProG, MonoSpin ProL

3

Products Related Life Sciences Analysis

MonoSpin ProA, MonoSpin ProG, MonoSpin ProL

MonoSpin ProA, MonoSpin ProG and MonoSpin ProL are already immobilized onto a silica monolith offering rapid purification of antibodies. Additionally, a 96-well plate format is available to purify a multi-analyte. Each reagent for the purification of samples is attached.



【Shapes】

Spin Column Type



- Purification with compact tabletop centrifuge just in two minutes (e.g., 2,300 × g)
 - Appropriate for purification of small volume sample (approximately 0.4 mg)
- Maximum sample volume : 500 μ L
Elution volume : 50 μ L Sample
loading capacity : ProA 400 μ g, ProG 300 μ g, ProL 200 μ g

96 Well plate Type



- Purification by both aspiration or centrifuge
 - Available for a multi-analyte with the same spin column volume.
- Maximum sample volume : 500 μ L
Elution volume : 50 μ L Sample
loading capacity : ProA 400 μ g, ProG 300 μ g

Large Spin Column



- Maximum 16 mg antibody can be recovered by centrifuge.
- Maximum sample volume : 8 mL
Elution volume : 2 mL Sample
loading capacity : ProA 16 mg, ProG 12 mg

MonoSpin ProA, MonoSpin ProG, MonoSpin ProL

Description	Qty.(pcs)	Cat.No.
MonoSpin ProA column	10	7510-11310
MonoSpin ProG column	10	7510-11311
MonoSpin ProL column	6	7510-11317
MonoSpin ProA 96 well plate	1	7510-11312
MonoSpin ProG 96 well plate	1	7510-11313
MonoSpin L ProA	4	7510-11314
MonoSpin L ProG	4	7510-11315
MonoSpin ProA/G buffer kit	-	7510-11316

Phosphorylated Protein Research

The study of reversible phosphorylation plays an important role in elucidating many cellular phenomena, including cell cycle, cell growth, apoptosis, and differentiation. However, when analyzing phosphopeptides in proteins, there are cases in which phosphopeptides are difficult to detect by MS because of their small amounts and low ionization efficiency. To solve this problem, GL Sciences offers the Titansphere series, which is optimized for the purification and concentration of phosphopeptides using titanium dioxide (titania) to specifically adsorb phosphopeptides.

Adsorption Mechanism

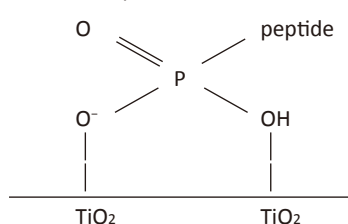

● Principle

- It is believed that phosphate groups and titanium dioxide adsorb under acidic conditions.
- Various studies have shown that titania and phosphopeptides bind selectively to each other. Evaluating the performance of titania optimized for the purification and concentration of phosphopeptides and the stability achieved only by in-house synthesis.

Titansphere TiO Bulk Materials (Titania Dioxide)

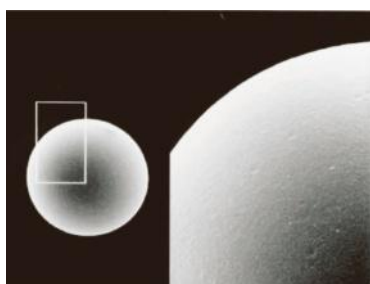

Titania Bulk Material

Titansphere TiO is a high-performance bead made of titania (titanium dioxide: TiO₂) synthesized into uniform porous spherical particles that can selectively concentrate and purify phosphopeptides.

● Specification

Description	Specification
Particle Size	5 μm, 10 μm
Particle Shape	Spherical
Adsorption Spot	Titanium Dioxide Crystal
Pore Size	100 Å
pH Range	2 ~ 12
Gravity	1.74

Note: This filler was developed with the cooperation of Dr. Hiroshi Nakamura, who was affiliated with the Faculty of Pharmaceutical Sciences, Tokyo University of Science at the time of product development.

How to make a Titania Column

- (1) Put an Empore Disk C8 cut to an appropriate size in the tip of the tip for 200 μL and use it as a filter.
- (2) Titansphere TiO filler is stirred with CH₃CN/H₂O = 80/20 (v/v) and loaded into the tip. (Fill volume should be changed according to the purpose).
- (3) Pressurize with air from the top of the tip using a syringe.

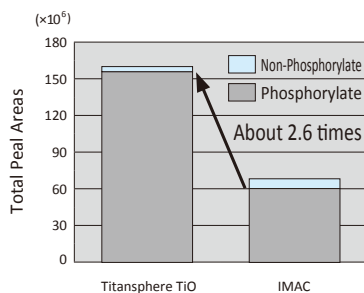
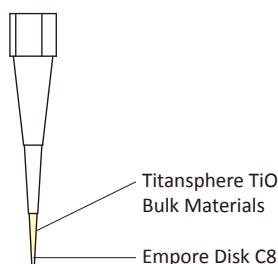

Comparison of Phosphorylated Peptide Recovery Amount

Compare Titansphere TiO with IMAC

Arabidopsis cell extracts were used to conduct a comparison study with commercial IMAC. Compared with IMAC, a high amount of phosphorylated peptides was detected, with a 2.6-fold increase in the total peak area of phosphorylated peptides and a 1.8-fold increase in the peptide identification constant.

Description	Specification	Volume	Cat.No.
Titansphere TiO	5 μm	500 mg	5020-75000
	10 μm	500 mg	5020-75010

Titansphere Phos-TiO Kit



Tip Column

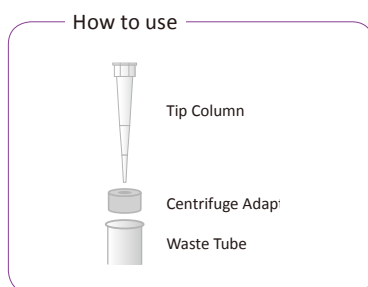

This kit includes a chip column, dedicated buffer, and protocols. The chip columns are optimized for the Phos-TiO Kit to enhance the adsorption capacity and the efficient purification and concentration of phosphopeptides. The Phos-TiO MP kit is also suitable for the purification and enrichment of multiple phosphorylated peptides.

● Specification

Sorbent Mass/Tip Volume	1 mg/10 µL	3 mg/200 µL
Sample Loading Capacity	1.2 µg	3.5 µg

Sample: Tyr(PO₃H₂)-Angiotensin II

● Features

- High selectivity
Due to its high affinity toward peptides containing phosphate groups, phosphopeptides can be detected by MS even in unstimulated cell extracts containing small amounts of phosphopeptides.
- Easy operation
The operation process consists of only five steps. It can be purified and concentrated in a short time, with an operation time of approximately 40 min. In addition, each step is performed entirely by centrifugation. Therefore, human error is minimized, and the system can be easily operated by anyone.
- Small-large numbers of samples can be handled.
Since the chip column is a stand-alone unit, experiments can be performed from one sample to many samples at once using a dedicated centrifugal adapter (sold separately).

Description	Sorbent Mass/Tip Volume	Qty.	Cat.No.
Titansphere Phos-TiO Kit	1 mg/10 µL	24 Times	5010-21300
	3 mg/200 µL	24 Times	5010-21305
	3 mg/200 µL	96 Times	5010-21306
TitanspherePhos-TiO MP kit	1 mg/200 µL	24 Times	5010-21280
	3 mg/200 µL	24 Times	5010-21281

Note: A centrifugal adapter is required for operation. Please purchase separately.



Centrifuge Adapter

Description	Sorbent Mass/Tip Volume	Qty.	Cat.No.
Titansphere Phos-TiO Tip	1 mg/10 µL	24 pcs	5010-21302
		96 pcs	5010-21303
	1 mg/200 µL	24 pcs	5010-21316
		96 pcs	5010-21317
	3 mg/200 µL	24 pcs	5010-21307
		96 pcs	5010-21308



For 10 µL Tip
96WP Centrifuge Adapter



For 200 µL Tip
96WP Centrifuge Adapter

Description	Particle Size	Qty.	Cat.No.
Titansphere Phos-TiO Bulk	10 µm	500 mg	5010-21315

Description	Sorbent Mass/Tip Volume	Qty.	Cat.No.
Centrifuge Adapter	10 µL, 200 µL	24 pcs	5010-21514
96WP Centrifuge Adapter	10 µL	1 pc	5010-21340
	200 µL	1 pc	5010-21341

Phosphorylation Purification & Enrichment

3

Products Related Life Sciences Analysis

Titansphere Phos-TiO



A syringe-barrel type cartridge column is used for the selective collection and concentration of phosphorylated peptides with a larger loading capacity than that of the tip type.

From conditioning to elution, the process can be performed in a centrifuge. This reduces human error and makes it easy for anyone to operate.

Sorbent Mass/Tip Volume	50 mg/3 mL	100 mg/3 mL
Particle Size	10 μm	
Sample Loading Capacity	60 μg	120 μg

Note: The loading volume is a guide when Tyr (PO₃H₂)-Angiotensin II is used. The maximum sample load varies depending on the state of the matrix.

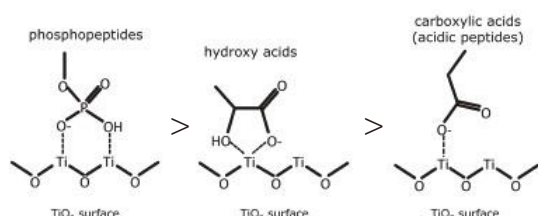

Principle

Titanium dioxide is thought to adsorb with high affinity for phosphate groups. However, our recommended purification method using a lactic acid solution (hydroxy acid) prevents the adsorption of non-phosphorylated peptides because the lactic acid binds to the remaining active sites and inhibits the binding of the carboxyl groups.

How to Operate

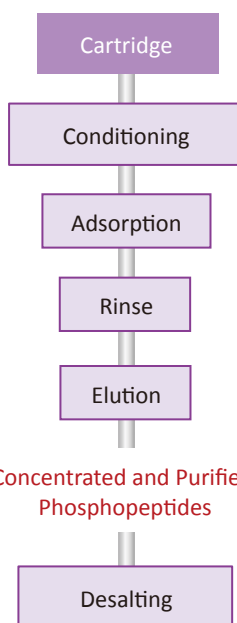

From conditioning to elution, various solutions and samples are passed through a centrifuge. (Conditioning and elution solutions are listed as examples).

Note: Due to the small particle size, purification and concentration cannot be performed using a suction manifold.

Add Buffer A: 80 % Acetonitrile (0.5 % TFA), then centrifuge
Add Buffer B: 300 mg/mL of Lactic acid in Buffer A, then centrifuge

Add 5 % ammonium aqueous solution, then centrifuge.
Add 5 % pyrrolidine aqueous solution, then centrifuge

MonoSpin C18 is recommended for desalting. (Page 128)
For more information on desalination, please contact us separately.

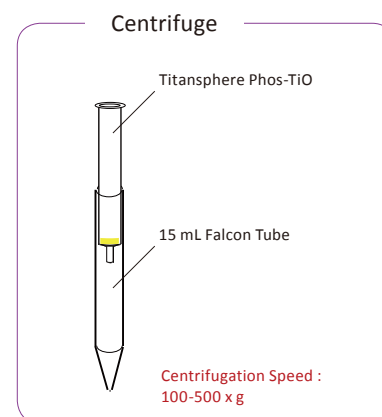

Description	Sorbent Mass/Tip Volume	Qty.(pk unit)	Cat.No.
Titansphere Phos-TiO	50 mg/3 mL	25 pcs(1 pc)	5010-21290
	100 mg/3 mL	25 pcs(1 pc)	5010-21291
Description	Volume	Cat.No.	
Lactic Acid for Titansphere Phos-TiO 3mL Cartridge	15 mL	5010-21295	

Tip Columns for Enrichment of Phosphopeptides

MonoTip TiO

MonoTip TiO is a pretreatment tip consisting of a matrix silica gel coated with titanium dioxide that selectively collects phosphopeptides.

Using MonoTip TiO to collect only phosphorylated peptides, the detection sensitivity can be improved, and the time required for analysis can be reduced



● Features

- Peptides can be easily purified by pipetting. Unlike the case in the IMAC method, no metal coordination bonding process is required here, and there is no metal dropout.
- Sample volume: 50–200 μL . Each chip can hold $\sim 5 \mu\text{g}$ of phosphopeptide and can be concentrated by reducing the eluate.

Appication

Sample : β -Casein

1 phosphopeptide : FQpSEEQQTEDELQDK(MW=2061)

4 phosphopeptides: RFLEELNVPGEIVEpSLpSpSpSpSEESLTR(MW=3122)

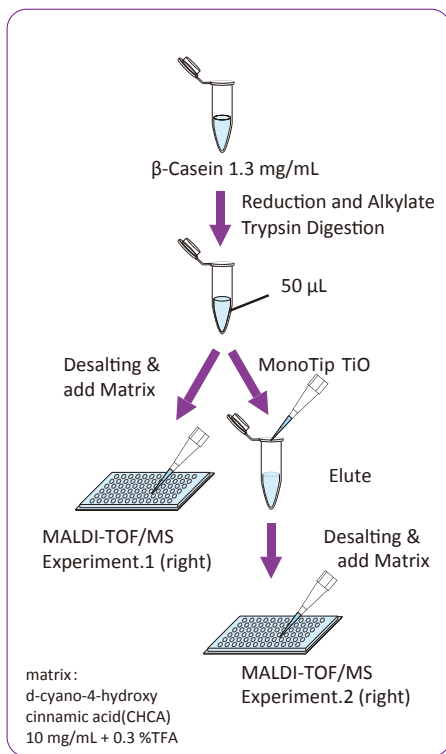

Experiment 1: Sample before purification (phosphorylated peptides are barely detectable)

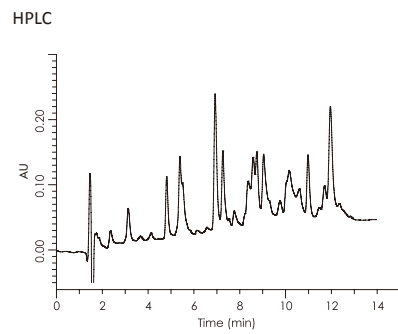

Many types of digests are observed

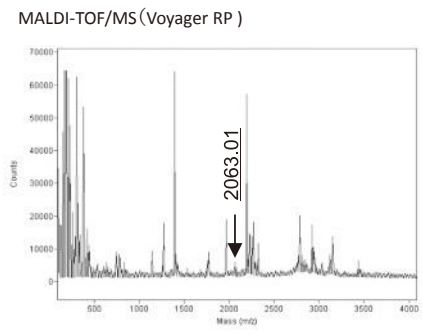

Detects only monophosphorylated peptides

Experiment 2: Post-purification sample (can be selectively extracted from many peptides)

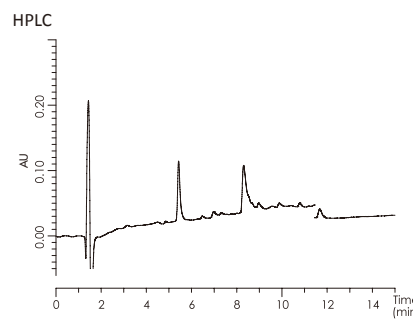

Only two types of digests are observed. Purification effect by MonoTip will be confirmed.

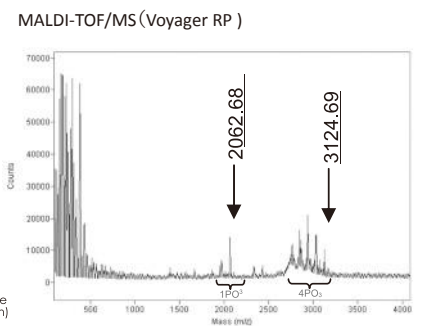

Phosphorylated peptides and tetraphosphorylated peptides in significant amounts are detected.

Specification

Description	Specification
Operation time	Approx. 6 mins
Suitable sample volume	20 ~ 200 μL
Sample loading volume	$\sim 5 \mu\text{g}$
Tip volume	200 μL

Description	Specification
Packing material	Silica Monolith (Highly pure silica gel)
Through-pore Diameter	10 ~ 20 μm
Meso-pore Diameter	20 nm
Surface area	200 m^2/g
Functional group	Dioxide titan coating

Description	Volume	Qty.	Cat.No.
MonoTip TiO	200 μL	24 pcs	5010-21007
		96 pcs	5010-21005

GL-Tip Series

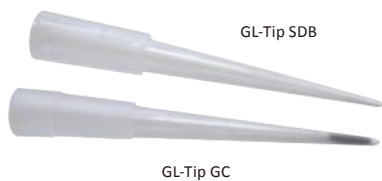

How to operate

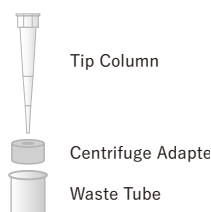

Prepare a centrifuge capable of operating at 3000 x g.

Peptide Desalting and Enrichment Tip

GL-Tip SDB is a 200- μ L tip filled with SDB (styrene divinylbenzene) polymer. Trapping with SDB chips, which have even stronger retention than C18 (silica matrix), reduces the peptide loss and enables efficient desalting.

The GL-Tip GC packed with GC can trap highly hydrophilic peptides and can be used in conjunction with the GL-Tip SDB to improve peptide identification.

Spin Tips for Peptide Fractionation GL-Tip SCX / GL-Tip SDB-SCX

GL-Tip SCX is a chip filled with SCX (cation-exchange resin), and GL-Tip SDB-SCX is a chip combining the SDB (styrene divinyl benzene) polymer and SCX.

The GL-Tip SDB-SCX can perform desalting in the first stage of SDB, allowing the direct handling of salt-containing samples.

Comparison of salinity gradient and TFA gradient methods

Conventionally, peptide fractionation is performed by elution using a salt-concentration gradient; however, the same peptides are often mixed in the fractions before and after, resulting in inefficiency due to the identification of the same peptides. However, the use of a more efficient TFA gradient method (patent pending), which is an improvement over the salinity gradient method, is expected to improve the peptide identification constant and efficiency. The GL-Tip SCX is a chip optimized for the TFA gradient method.

Its fractionation efficiency was tested using phosphorylated peptides derived from human colon cancer DLD-1 established cells. The TFA gradient method identified 14,307 peptides with the same constant, indicating high efficiency. In addition, few overlapping peptides were observed in the eluate, allowing for efficient identification.

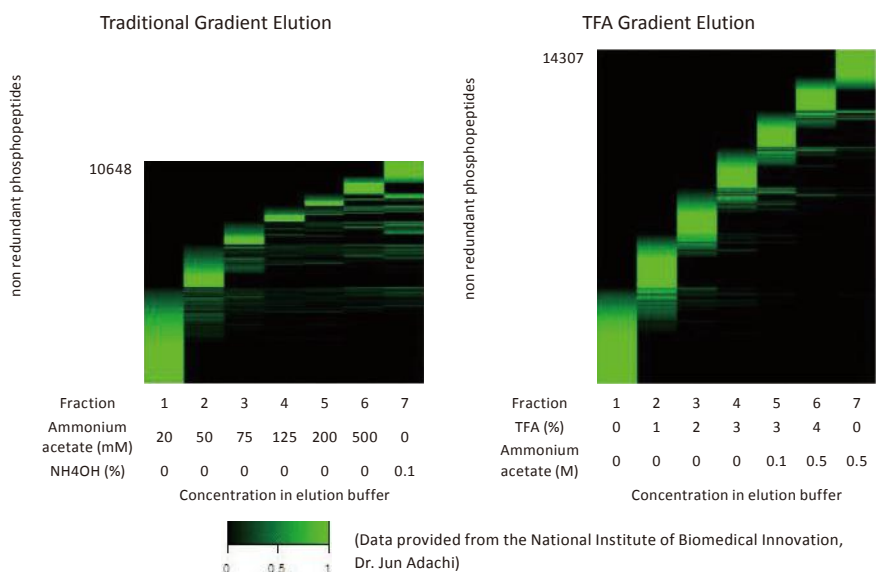

Description	Volume	Sample Loading Capacity (Reference)	Qty.	Cat.No.
GL-Tip SDB	200 μ L	60 μ g	96 pcs	7820-11200
GL-Tip GC	200 μ L	30 μ g	96 pcs	7820-11201
GL-Tip SDB-SCX	200 μ L	60 μ g	96 pcs	7510-11202
GL-Tip SCX	200 μ L	60 μ g	96 pcs	7510-11203
Centrifuge Adapter	For 10/200 μ L Tip Column	-	24 pcs	5010-21514

Note: GL-Tip SCX and SDB-SCX were developed in cooperation with Dr. Takeshi Asanaga and Dr. Jun Adachi of the National Institute of Biomedical Innovation, Health and Nutrition. GL-Tip SCX and SDB-SCX are products based on patent pending technology.

4. Cat.No. Index

Cat.No. Index

1030

-55102	75
-55105	75
-55110	75
-55120	75

3008

-41151	73
--------	----

5010

-21000	85
-21002	85
-21005	93
-21007	93
-21280	91
-21281	91
-21290	92
-21291	92
-21295	92
-21300	91
-21302	91
-21303	91
-21305	91
-21306	91
-21307	91
-21308	91
-21315	91
-21316	91
-21317	91
-21340	91
-21341	91
-21395	87
-21514	91/94
-21670	83
-21671	83
-21696	83
-21697	83
-21698	83
-21699	83
-21700	83
-21701	83
-21705	83
-21706	83
-21710	83
-21711	83
-21715	83
-21716	83
-21720	83
-21721	83
-21725	83
-21726	83
-21727	83
-21728	83
-21729	83
-21730	83
-21731	83
-21732	83
-21733	83
-21734	83
-21735	83
-21736	83
-21737	83
-21738	83
-21740	83
-21741	83
-21742	83
-21900	84
-21901	84

-21902	84
-21903	84
-21904	84
-21905	84
-21906	84
-21907	84
-21908	84
-23500	61
-23501	61
-23510	61
-23520	61
-25020	13
-25025	13
-25030	13
-25035	13
-25036	13
-25050	13
-25051	13
-25200	13
-25205	13
-25500	54
-26020	13
-27100	15
-27101	15
-27102	15
-27103	15
-27104	15
-27105	15
-27111	15
-27113	15
-27114	15
-27205	16
-27210	18
-27215	24
-27216	25
-27235	17
-27240	19
-27300	16
-27301	16
-27302	16
-27303	16
-27304	16
-27305	16
-27306	16
-27307	16
-27319	17
-27320	17
-27321	17
-27322	17
-27323	17
-27324	17
-27325	17
-27326	17
-27327	17
-27330	17
-27331	17
-27350	18
-27351	18
-27352	18
-27353	18
-27354	18
-27355	18
-27356	18
-27357	18
-27370	19
-27371	19
-27372	19
-27373	19
-27374	19
-27375	19
-27376	19

-27377	19
-27400	24
-27401	24
-27402	24
-27403	24
-27404	24
-27405	24
-27406	24
-27407	24
-27410	25
-27411	25
-27412	25
-27413	25
-27414	25
-27415	25
-27416	25
-27417	25
-27430	13
-27431	13
-27520	12
-27521	12
-27522	12
-27523	12
-27524	12
-27525	12
-27532	12
-27533	12
-27534	12
-27535	12
-27536	12
-27537	12
-27538	12
-27539	12
-27540	12
-27541	12
-27556	21
-27565	20
-27566	20
-27576	21
-27591	20
-27620	15
-27621	15
-27622	15
-27623	15
-27624	15
-27625	12
-27626	12
-27630	16
-27631	16
-27632	16
-27633	16
-27634	16
-27640	17
-27641	17
-27642	17
-27643	17
-27644	17
-27645	17
-27650	18
-27651	18
-27652	18
-27653	18
-27654	18
-27660	19
-27661	19
-27662	19
-27663	19
-27664	19
-27670	24
-27671	24
-27672	24

-27673	24
-27674	24
-27681	25
-27682	25
-27683	25
-27684	25
-27810	59
-27811	59
-30250	14
-33071	74
-50014	67
-50015	67
-50016	67/69
-50017	67
-50018	67
-50019	67
-50020	67
-50022	67
-50024	67
-50026	66
-50027	66
-50028	66
-50029	66
-50030	66
-50032	67
-50033	67
-50040	66
-50041	67
-50122	67/69
-50123	67
-50124	67
-50125	67
-50127	67/69
-50128	67
-50129	67
-50134	73
-50150	74
-50155	74
-50160	74
-50161	74
-50162	74
-50163	74
-50165	74
-50166	74
-50167	74
-50168	74
-50169	74
-50211	70
-50212	66/70
-50213	70
-50214	70
-50230	65
-50233	65
-50234	65
-50235	65
-50236	73
-50237	67
-50238	67
-50239	67
-50240	67/71
-50241	67/71
-50242	67/71
-50243	67
-50244	67
-50246	67/71
-50247	67
-50249	67/71
-50251	73
-50252	73
-50253	67/71
-50254	67

-50256	67/71/73	-60156	68	-61165	34	-61400	41
-50336	59/68	-61000	26	-61166	34	-61401	41
-50410	72	-61001	26	-61167	34	-61402	41
-50420	72	-61002	26	-61168	34	-61403	41
-50421	72	-61003	26	-61180	35	-61404	41
-50422	72	-61004	26	-61181	35	-61405	41
-50423	72	-61005	26	-61182	35	-61406	41
-50424	72	-61006	26	-61183	35	-61407	41
-50425	72	-61007	26	-61184	35	-61408	41
-50430	72	-61008	26	-61185	35	-61420	43
-50431	72	-61009	26	-61186	35	-61421	43
-50432	72	-61010	26	-61187	35	-61422	43
-50433	72	-61011	26	-61188	35	-61423	43
-50434	72	-61012	26	-61189	35	-61424	43
-50440	72	-61013	26	-61190	35	-61425	43
-50441	72	-61014	26	-61191	35	-61426	43
-50450	87	-61015	26	-61192	35	-61427	43
-51001	70	-61016	26	-61204	31	-61428	43
-51002	70	-61020	28	-61300	36	-61440	44
-51010	70	-61021	28	-61301	36	-61441	44
-51011	70	-61022	28	-61302	36	-61442	44
-51012	70	-61023	28	-61303	36	-61443	44
-51013	66/70	-61024	28	-61304	36	-61444	44
-51014	66/70	-61025	28	-61305	36	-61445	44
-51015	70	-61026	28	-61306	36	-61446	44
-51016	70	-61027	28	-61307	36	-61447	44
-51017	70	-61028	28	-61308	36	-61448	44
-51020	70	-61040	29	-61320	37	-61453	44
-51021	70	-61041	29	-61321	37	-61500	45
-51031	75	-61042	29	-61322	37	-61501	45
-51032	75	-61043	29	-61323	37	-61502	45
-51033	75	-61044	29	-61324	37	-61503	45
-51039	70	-61045	29	-61325	37	-61504	45
-51040	70	-61046	29	-61326	37	-61505	45
-51041	70	-61047	29	-61327	37	-61506	45
-51042	70	-61048	29	-61328	37	-61507	45
-52011	71	-61049	29	-61329	37	-61508	45
-52012	71	-61050	29	-61330	37	-61509	45
-52013	71	-61051	29	-61331	37	-61510	45
-52015	75	-61052	29	-61332	37	-61511	45
-52016	75	-61080	32	-61340	38	-61520	46
-52021	75	-61081	32	-61341	38	-61521	46
-52022	75	-61082	32	-61342	38	-61522	46
-60000	59/66/68	-61083	32	-61343	38	-61523	46
-60001	59/68	-61084	32	-61344	38	-61524	46
-60002	59/68	-61085	32	-61345	38	-61525	46
-60004	59/68	-61086	32	-61346	38	-61526	46
-60010	66/67/69/72	-61087	32	-61347	38	-61527	46
-60015	59/69	-61088	32	-61348	38	-61528	46
-60016	59/69	-61089	32	-61349	38	-61529	46
-60017	59/69	-61090	32	-61350	38	-61540	47
-60100	68	-61091	32	-61351	38	-61541	47
-60101	68	-61092	32	-61352	38	-61542	47
-60102	68	-61120	33	-61360	40	-61543	47
-60103	68	-61121	33	-61361	40	-61544	47
-60104	68	-61122	33	-61362	40	-61545	47
-60105	68	-61123	33	-61363	40	-61546	47
-60106	68	-61124	33	-61364	40	-61547	47
-60120	68	-61125	33	-61365	40	-61548	47
-60121	68	-61126	33	-61366	40	-61549	47
-60122	68	-61127	33	-61367	40	-61550	47
-60123	68	-61128	33	-61368	40	-61551	47
-60124	68	-61129	33	-61380	42	-61552	47
-60125	68	-61130	33	-61381	42	-61553	47
-60126	68	-61131	33	-61382	42	-61600	49
-60150	68	-61132	33	-61383	42	-61601	49
-60151	68	-61160	34	-61384	42	-61602	49
-60152	68	-61161	34	-61385	42	-61603	49
-60153	68	-61162	34	-61386	42	-61604	49
-60154	68	-61163	34	-61387	42	-61605	49
-60155	68	-61164	34	-61388	42	-61606	49

Cat.No. Index

4

Cat.No. Index

-61607	49	-62012	27	-62751	22	-63641	52
-61608	49	-62040	30	-62752	22	-63642	52
-61609	49	-62041	30	-62753	22	-63643	52
-61610	49	-62042	30	-62754	22	-63651	53
-61611	49	-62043	30	-62755	22	-63652	53
-61612	49	-62044	30	-62760	22	-63653	53
-61620	51	-62045	30	-62761	22	-63661	48
-61621	51	-62046	30	-62762	22	-63662	48
-61622	51	-62047	30	-62763	22	-63663	48
-61623	51	-62048	30	-62764	22	-64001	27
-61624	51	-62049	30	-62765	22	-64002	27
-61625	51	-62050	30	-63001	26	-64003	27
-61626	51	-62051	30	-63002	26	-64041	30
-61627	51	-62052	30	-63003	26	-64042	30
-61628	51	-62340	39	-63021	28	-64043	30
-61629	51	-62341	39	-63022	28	-64341	39
-61640	52	-62342	39	-63023	28	-64342	39
-61641	52	-62343	39	-63041	29	-64343	39
-61642	52	-62344	39	-63042	29	-64601	50
-61643	52	-62345	39	-63043	29	-64602	50
-61644	52	-62346	39	-63081	32	-64603	50
-61645	52	-62347	39	-63082	32	-65000	26
-61646	52	-62348	39	-63083	32	-65001	26
-61647	52	-62349	39	-63121	33	-65005	26
-61648	52	-62350	39	-63122	33	-65006	26
-61649	52	-62351	39	-63123	33	-65020	28
-61650	52	-62352	39	-63161	34	-65021	28
-61651	52	-62600	50	-63162	34	-65025	28
-61652	52	-62601	50	-63163	34	-65026	28
-61654	52	-62602	50	-63181	35	-65040	29
-61655	52	-62603	50	-63182	35	-65041	29
-61700	53	-62604	50	-63183	35	-65045	29
-61701	53	-62605	50	-63301	36	-65046	29
-61702	53	-62606	50	-63302	36	-65080	32
-61703	53	-62607	50	-63303	36	-65081	32
-61704	53	-62608	50	-63321	37	-65120	33
-61705	53	-62609	50	-63322	37	-65121	33
-61706	53	-62610	50	-63323	37	-65160	34
-61707	53	-62611	50	-63341	38	-65161	34
-61708	53	-62612	50	-63342	38	-65180	35
-61709	53	-62690	21	-63343	38	-65181	35
-61710	53	-62691	21	-63361	40	-65200	31
-61711	53	-62692	21	-63362	40	-65201	31
-61712	53	-62693	21	-63363	40	-65205	31
-61713	53	-62700	21	-63381	42	-65300	36
-61720	48	-62701	21	-63382	42	-65301	36
-61721	48	-62702	21	-63383	42	-65320	37
-61722	48	-62703	21	-63401	41	-65321	37
-61723	48	-62704	21	-63402	41	-65325	37
-61724	48	-62705	21	-63403	41	-65340	38
-61725	48	-62706	21	-63421	43	-65341	38
-61726	48	-62710	23	-63422	43	-65345	38
-61727	48	-62711	23	-63423	43	-65360	40
-61728	48	-62712	23	-63441	44	-65361	40
-61729	48	-62713	23	-63442	44	-65362	40
-61730	48	-62720	23	-63443	44	-65380	42
-61731	48	-62721	23	-63444	44	-65381	42
-61732	48	-62722	23	-63501	45	-65382	42
-61733	48	-62723	23	-63502	45	-65400	41
-62000	27	-62724	23	-63503	45	-65401	41
-62001	27	-62725	23	-63521	46	-65402	41
-62002	27	-62726	23	-63522	46	-65403	41
-62003	27	-62730	20	-63523	46	-65420	43
-62004	27	-62731	20	-63541	47	-65421	43
-62005	27	-62732	20	-63542	47	-65422	43
-62006	27	-62733	20	-63543	47	-65440	44
-62007	27	-62740	20	-63601	49	-65441	44
-62008	27	-62741	20	-63602	49	-65442	44
-62009	27	-62742	20	-63603	49	-65500	45
-62010	27	-62743	20	-63621	51	-65501	45
-62011	27	-62744	20	-63622	51	-65520	46
		-62750	22	-63623	51		

-65521	46
-65540	47
-65541	47
-65600	49
-65601	49
-65605	49
-65620	51
-65621	51
-65640	52
-65641	52
-65650	53
-65651	53
-65660	48
-65661	48
-65700	58
-65701	58
-65710	54
-65720	13
-65721	13
-65726	13
-65740	15
-65775	13
-65780	61
-65795	12
-65805	21
-65815	23
-65825	20
-65835	22
-66000	26
-66001	26
-66010	27
-66011	27
-66020	28
-66021	28
-66030	29
-66031	29
-66040	30
-66041	30
-66050	32
-66051	32
-66070	33
-66071	33
-66090	34
-66091	34
-66100	35
-66101	35
-66230	15
-66231	15
-66300	36
-66301	36
-66310	37
-66311	37
-66320	38
-66321	38
-66400	45
-66401	45
-66410	46
-66411	46
-66420	47
-66421	47
-66430	48
-66431	48
-66440	12
-66441	12
-66442	12
-66450	12
-66460	21
-66461	21
-66462	21
-66465	21
-66466	21

-66470	23
-66471	23
-66480	20
-66481	20
-66482	20
-66486	20
-66490	22
-66491	22
-66492	22
-66500	18
-66501	18
-66510	19
-66511	19
-66600	49
-66601	49
-66610	51
-66611	51
-66620	52
-66621	52
-66640	53
-66641	53
-66700	16
-66701	16
-66710	17
-66711	17
-66800	24
-66801	24
-68000	54
-68001	54
-68002	54
-68003	54
-68004	54
-68005	54
-68006	54
-68007	54
-68011	55
-68012	55
-68013	55
-68014	55
-68015	55
-68016	55
-68017	55
-68020	55
-68022	55
-68023	55
-68024	55
-68025	55
-68034	56
-68044	56
-68054	57
-68100	56
-68101	56
-68104	56
-68105	56
-68110	58
-68111	58
-68114	57
-68120	58
-68121	58
-68125	59
-68127	59
-68133	57
-68140	60
-68141	60
-68142	60
-68150	60
-68151	60
-68152	60
-68153	60
-68154	60
-68208	59

-68209	59
-68210	59
-68218	59
-68219	59
-68220	59
-69000	26
-69001	28
-69002	29
-69003	32
-69005	33
-69007	34
-69008	35
-69009	36
-69010	37
-69011	38
-69012	40
-69013	42
-69014	41
-69015	43
-69016	44
-69017	45
-69018	46
-69019	47
-69020	49
-69021	51
-69022	52
-69024	27
-69026	30
-69030	39
-69031	50
-69033	53
-69034	48
-69050	54
-69051	54
-69100	13
-69101	13
-69102	13
-69103	13
-69112	15
-69113	15
-69114	15
-69115	15
-69116	16
-69117	16
-69118	17
-69119	17
-69120	18
-69121	18
-69122	19
-69123	19
-69126	24
-69127	24
-69128	25
-69129	25
-69130	12
-69131	12
-69132	12
-69133	12
-69134	21
-69135	21
-69136	23
-69137	23
-69138	20
-69139	20
-69140	22
-69141	22
-69500	59

5020

-75000	90
--------	----

-75010	90
--------	----

5040

-29001	76
-29002	76
-29003	76
-29004	76
-29005	76
-29006	76
-29007	76
-29008	76
-29009	76
-29010	76
-29011	76
-29012	76
-29013	76
-29014	76
-29015	76
-29016	76

6045

-11000	67
--------	----

7510

-11021	79
-11037	79
-11202	94
-11203	94
-11302	83
-11310	89
-11311	89
-11312	89
-11313	89
-11314	89
-11315	89
-11316	89
-11317	89
-11320	84
-11321	84
-11322	84
-11323	84
-11324	84
-11325	84
-11326	84

7820

-11001	79
-11005	79
-11011	79
-11015	79
-11200	94
-11201	94

GL Sciences disclaims any and all responsibility for any injury or damage which may be caused by this data directly or indirectly.

We reserve the right to amend this information or data at any time and without any prior announcement. Please note that, in the interests of continuous improvement, models or specifications are subject to change without notice. Please also note that the company name and product name appearing in this catalogue are the trademark or registered trademark of each corresponding company. In the descriptions in this catalogue, TM and R marks are not used.

GL Sciences Inc. Japan

22-1 Nishishinjuku 6-chome
Shinjuku-ku, Tokyo
163-1130, Japan

Phone : +81-3-5323-6620
Fax : +81-3-5323-6621
Email : world@glsciences.co.jp
Web : www.glsciences.com

GL Sciences Inc. USA

4733 Torrance Blvd. Suite 255
Torrance, CA 90503
USA

Phone : +1-310-265-4424
Fax : +1-310-265-4425
Email : info@glsciencesinc.com
Web : www.glsciencesinc.com

GL Sciences B.V.

Dillenburgstraat 7C
5652AM, Eindhoven
The Netherlands

Phone : +31-40-254-9531
Email : info@glsciences.eu
Web : www.glsciences.eu

GL Sciences (Shanghai) Limited

Tower B, Room 2003
Far East International Plaza
No.317 Xianxia Road, Changning District
Shanghai, China 200051

Phone : +86-21-62782272
Email : contact@glsciences.com.cn
Web : www.glsciences.com.cn



International Distributors

Visit our Website at www.glsciences.com/distributors

