

CONSUMABLES GEARED TOWARDS THE FUTURE

INTERACTIVE PDF

[CLICK HERE TO VIEW THE MAIN INDEX](#)

2023 Chromatography Consumables and Supplies

GC | LC | Mass Spec | Sample Preparation



ORDERING ONLINE: IT'S THAT EASY



Sign Up and Get Started Today at www.perkinelmer.com/register

Quick and Efficient Three Steps - that's how easy it is to buy online

1. Visit www.perkinelmer.com
2. Click on "Login/Register" at the top of the web page to register.
All you need is your PerkinElmer account number.
3. Search for the product you need and add to your cart

Benefits of ordering online:

- Real time product availability
- Immediate order processing
- Order confirmations
- Shipment notifications
- Quick re-order
- Save items to favorites list
- Tracking information and updates
- All orders available in "my account" order history

Step 1: Quick registration.

Step 2: Shop by product number, alphabetical listing, or by technology.

Step 3: Checkout via your shopping cart.

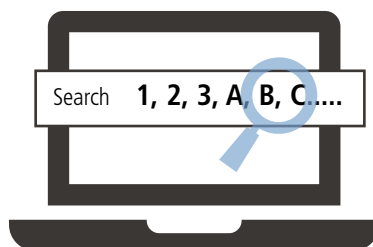

The power and convenience of real-time purchasing information are now available online.
When will the product ship? Shipment date of each item is visible in the shopping cart.

Shop Online today!

www.perkinelmer.com/category/consumables

Chromatography

Today's advanced and increasingly diverse Advanced Materials laboratories are facing new challenges on a daily basis – starting from raw materials right up to the finished product. PerkinElmer's comprehensive portfolio of analytical solutions is designed to give you the higher accuracy, sensitivity, and ease of use your laboratory demands for examining with confidence, the purity, composition, and performance of your compounds. What's more, a range of complementary services is available to keep your laboratory up and running, meeting the stringent requirements of a variety of environments and working practices.

Better insights for better products.

CHOOSE PERKINELMER.

Ordering Information

Place your order online at: www.perkinelmer.com

Online ordering is currently available in Australia, Austria, Belgium, Canada, China, Denmark, Finland, France, Germany, Ireland, Italy, Luxembourg, the Netherlands, Norway, Puerto Rico, Singapore, Spain, Sweden, Switzerland, the United Kingdom and the United States.

Please visit our website for specific Country/Region details relevant to each business portfolio. **Country Specific Fact Sheets.**

Return Goods Policy

Before returning any item to PerkinElmer, please obtain a Return Authorization Number from a customer service representative. Call your local PerkinElmer office and please have the following information ready:

- Our Order Number or your Purchase Order Number.
- The PerkinElmer part numbers of the items that you wish to return.
- Reason for return.

Our customer service representative will provide you with a Return Authorization Number and the return address. We cannot accept any returns without a Return Authorization Number. Policy may vary. Please contact your local PerkinElmer representative for details.

Technical Support

For technical assistance, please contact your local PerkinElmer Customer Care Representative. See local office listings.

Check with your local PerkinElmer Customer Care center for current pricing.

PerkinElmer and the PerkinElmer logo are registered trademarks of PerkinElmer, Inc. All other product and company names mentioned herein may be the trademarks or registered trademarks of their respective owners.

PerkinElmer is not responsible for typographical or photographic errors that may appear in this catalog. We reserve the right to make adjustments or corrections due to changing market conditions, product discontinuations, or typographical or photographic errors in advertisements or product descriptions. Terms and conditions and item availability are subject to change without notice.

Terms and Conditions

For details on our terms and conditions, including warranties, please visit: **Terms and Conditions of Sale**

Table of Contents

>	SPE, SYRINGES & FILTERS	4–16
>	VIALS, CAPS AND SEPTA	17–36
>	LC COLUMNS	37
>	LC ACCESSORIES & CONSUMABLES	38–61
>	GC COLUMNS	62–88
>	GC CONSUMABLES & ACCESSORIES	89–119
>	THERMAL DESORPTION	120–124
>	ARNEL ANALYZER CONSUMABLES	125–134
>	TORION ACCESSORIES & CONSUMABLES	135–140
>	GAS MANAGEMENT	141–164
>	STANDARDS	165–170

SPE, Syringes & Filters

PerkinElmer offers a wide selection of superior quality products designed to work with your PerkinElmer instruments. Our precision designed products deliver the peace of mind that comes from knowing that you'll get the results you need.

Quick Reference Index

	Page
➤ Nylon Syringe Filters	16
➤ PTFE (hydrophobic) Syringe Filters	16
➤ PTFE (hydrophilic) Syringe Filters	16
➤ PVDF Syringe Filters	16
➤ SPE Application and Selection Packs	14
➤ SPE Vacuum Pumps and Manifolds	15
➤ Supra-Clean and Supra-Poly SPE Application Overview	6-7
➤ Supra-Clean Columns and Cartridges	8
➤ Supra-Poly HLB Columns	10
➤ Supra-Poly Columns	11
➤ Supra-d QuEChERS Dispersive SPE	12
➤ Supra-d QuEChERS for Multiple Pesticide Residue Analysis	13
➤ Syringes	15

QuEChERS

We provide a complete range of products for QuEChERS methodologies, offering all three standard QuEChERS methods: Original QuEChERS method, American AOAC Standard (Official Method 2007.01) QuEChERS method and European Standard (EN 15662) QuEChERS method.



[VIEW PAGE](#)

SPE Cartridges

We offer a broad array of analytes and matrices to fit your applications. Our SPE solutions are available in a variety of formats including Large Reservoir Capacity (LRC) columns, Polypropylene (PP) columns and cartridges, and also glass columns. Each technology is offered with a wide selection of polymer and silica sorbents, and large and small sample volumes (50 µL to 1 L) allow you to perform scalable analyzes depending upon your required detection limits.



[VIEW PAGE](#)

SPE Application Packs

Ideal for extraction of known entities from a variety of matrices, our packs are expertly tailored to meet your application needs and are designed to support major EPA methods and applications.

[VIEW PAGE](#)

SUPRA-CLEAN

SUPRA-POLY

QUECHERS

PUMPS AND
MANIFOLDS

SYRINGES

SYRINGE FILTERS

Supra-Clean and Supra-Poly SPE Solutions

Recovery, capacity, selectivity and reproducibility are the principal sample prep demands of today's analyst. We have developed an innovative SPE product range incorporating silica and polymer based technology. Supra-Clean® (silica) and Supra-Poly® (polymer) deliver the recovery, reproducibility, and reliability desired for consistently excellent results.

Both utilize Precise Bed Technology® (PBT) with our spherical media (Figure 1) allowing columns to be evenly and consistently filled with particles sized for optimum distribution. This homogeneous filling yields a +/- 1% variation in bed volume precision, ensuring you experience repeatability and optimized recovery reproducibility.

Spherical media and consistent particle distribution enable smaller elution volumes and better, more reproducible extraction, purification, concentration and recovery.



Figure 1: Comparison of Spherical and Irregular Media.

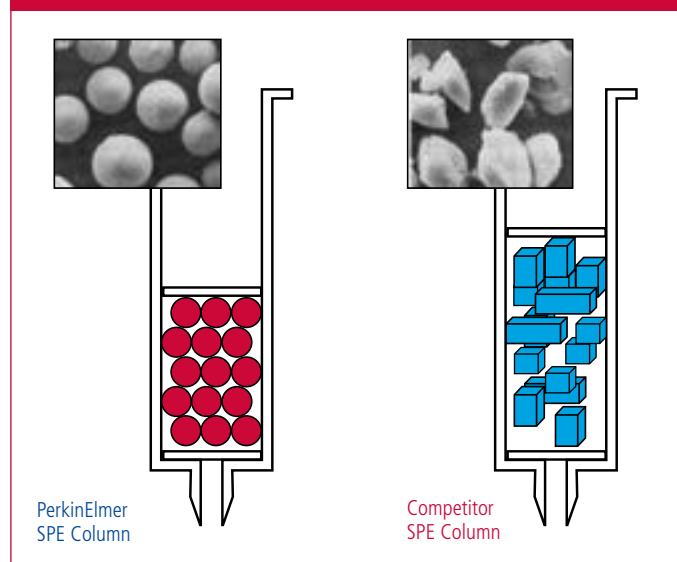
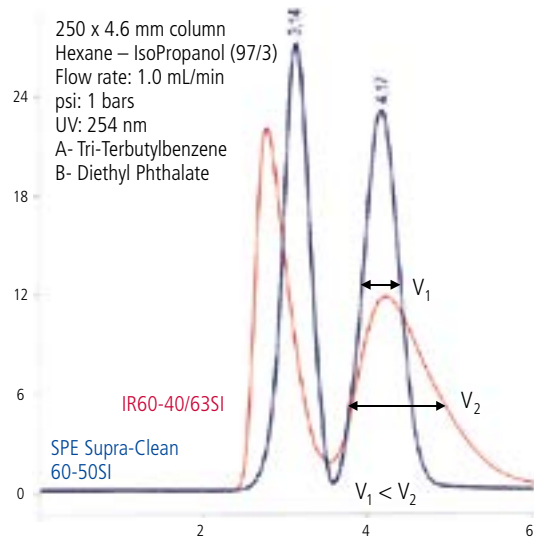

Figure 2: Performance Comparison of PerkinElmer Spherical SPE Media vs. Leading Irregular SPE Silica.



PerkinElmer's smaller, more homogeneous, spherical media deliver sharper, narrower peaks for faster, more accurate sample analysis.

Ideal for a broad array of analytes and matrices, our SPE solutions are available in a variety of formats including Large Reservoir Capacity (LRC) columns, Polypropylene (PP) columns and cartridges, and also glass columns. Each technology is offered with a wide selection of polymer and silica sorbents, and large and small sample volumes (50 μ L to 1 L) allow you to perform scalable analytes depending upon your required detection limits.

Each finished product is delivered with an individual quality certificate.

Supra-Clean and Supra-Poly Application Overview

Supra-Clean Spherical Silica											
Phase	Mechanism	Interaction Mode	Compounds	Matrix	Typical Applications	pH Range	End-Capping	Pore Size (Å)	Surface Area (m ² /g)	Particle Size (µm)	Comments
C18-S	Hydrophobic	Reversed Phase	Polar to Non-Polar compounds	Biological fluids, aqueous samples	Drugs and drug metabolites in biological matrices, trace organic material in water, toxins in food	2 – 8	Yes	60	500	50	18% Carbon Load (CL)
High Recovery REC18	Hydrophobic	Reversed Phase	Non-polar and mid-polar compounds including 100% water solvents	Biological fluids, aqueous samples toxins in food	Drugs and drug metabolites in biological matrices, trace organic material in water	2 – 8	Yes	–	–	50	High capacity and better recovery especially for high aqueous conditions. 15% CL
Phenyl (PH-S)	Hydrophobic	Reversed Phase	Non-polar to mid-polar aromatic compounds	Biological fluids	Benzodiazepines in biological matrices, extraction of aromatic compounds	2 – 8	No	60	500	50	9% CL
Silica (SI-S)	Hydrophilic	Normal Phase	Polar compounds	Non-polar organics, oils, lipids	Aldehydes, amines, pesticides, herbicides, carotenoids, fat soluble vitamins, aflatoxins, fatty acids, and phospholipids	2 – 8	No	60	500	50	Bare Silica
Amino (NH ₂ -S)	Hydrophilic	Normal Phase	Polar to Mid-Polar aromatic compounds	Biological fluids, aqueous samples, buffered organics	Basic compounds, polar amine compounds, carbohydrates	2 – 8	No	60	500	50	5% CL
Strong Cation Exchange (SCX)	Ion Exchange	Ion Exchange	Basic compounds	Biological fluids, aqueous samples, buffered organics	Cations, antibiotics, drugs, amino acids, catecholamines, herbicides, nucleic acid bases, nucleosides, and surfactants	2 – 8	No	60	450	60	Strong Acid – Sulfonic acid; Exchange capacity 0.70 meq/g
Weak cation Exchange (WCX)	Ion Exchange	Ion Exchange	Strong basic compounds	Biological fluids, aqueous samples	Cations, amines, antibiotics, drugs, amino acids, catecholamines, nucleic acid bases, nucleosides, and surfactants	2 – 8	No	60	450	60	Weak Acid – Carboxylic acid; Exchange capacity 0.22 meq/g
Strong Anion Exchange (SAX)	Ion Exchange	Ion Exchange	Acidic compounds	Biological fluids, aqueous samples	Acidic food pigments, organic acids, phenol compounds, nucleic acids, nucleotides, surfactants	2 – 8	No	60	450	60	Strong Base – quaternary amine; Exchange capacity 0.30 meq/g
Cyano (CN-S)	Hydrophilic	Normal Phase	Polar to Mid-Polar compounds	Non-polar organics, oils, lipids	Polar compounds in hexane and oil	2 – 8	Yes	60	500	50	8% CL; Mid-range polarity between silica and C18
Florisil (FL-S)	Hydrophilic	Normal Phase	Polar compounds	Ideal for polar compounds in non-polar matrix	Pesticides, Polychlorinated Biphenyls (PCB)	2 – 8	No	–	–	200	Standard grade. Alternative to silica for viscous matrices due to large particle size
Florisil Pesticide (FL-S)	Hydrophilic	Normal Phase	Polar compounds	Ideal for polar compounds in non-polar matrix	Pesticides	2 – 8	No	–	–	200	High purity pesticide grade. Alternative to silica for viscous matrices
Polyamine (P6)	Hydrophilic	Reversed Phase	Carboxylic acids, phenolics and nitroaromatics	Aqueous and mid-polar matrices	Aromatic and natural products; Flavones, Chalkones, Anthraquinones	2 – 8	No	–	–	100	Nylon 6
300 A (C4)	Hydrophobic	Reversed Phase	Non-polar to mid-polar compounds	Biological Samples	Hydrophobic peptides and polypeptides	2 – 8	No	300	–	–	Large pore size for isolation of large biomolecules
LCC	Hydrophobic	Reversed Phase	Non-polar to mid-polar compounds	Biological fluids, aqueous samples	Non-polar compounds in aqueous solution	2 – 8	Yes	60	500	50	10% CL; Lower carbon load than C18-S and REC18
Mixed mode (MM1)	Ion Exchange/ Hydrophobic	Reversed Phase/SCX	Basic compounds	Biological samples	Drugs and drug metabolites	2 – 8	No	60	450	60	Exchange capacity 0.09 meq/g
Mixed mode (MM2)	Ion Exchange/ Hydrophobic	Reversed Phase/WCX	Very basic compounds	Biological samples	Drugs and drug metabolites	2 – 8	No	60	450	60	Exchange capacity 0.10 meq/g
Mixed mode (MM3)	Ion Exchange/ Hydrophobic	Reversed Phase/SAX	Acidic compounds	Biological samples	Drugs and drug metabolites	2 – 8	No	60	450	60	Exchange capacity 0.14 meq/g

Supra-Poly Spherical Polymer											
Phase	Mechanism	Interaction Mode	Compounds	Matrix	Typical Applications	pH Range	End-Capping	Pore Size (Å)	Surface Area (m ² /g)	Particle Size (µm)	Comments
Extreme Capacity (XC)	Hydrophobic	Reversed Phase	Polar and non-polar	Aqueous or organic	Drugs and drug metabolites biological fluids	0 – 14	No	–	1500	70	High capacity polystyrene-divinylbenzene (PSDVB)
Extreme Capacity Wide Pore (XWP)	Hydrophobic	Reversed Phase	Polar and non-polar	Biological and viscous samples	Drugs and drug metabolites biological fluids	0 – 14	No	Wide Pore	1200	90	High capacity PSDVB for large biomolecules and viscous matrices
Hydrophilic (ATH)	Hydrophilic	Reversed Phase	Mid to non-polar compounds	Aqueous or organic	Mid-polar and non-polar compounds in aqueous and organic solvents	1 – 13	No	70	800	75	Mixed hydrophilic/hydrophobic interactions
Lipophilic (ATL)	Lipophilic	Reversed Phase	Mid to non-polar compounds	Crude samples	Lipids	0 – 14	No	70	800	100	PSDVB; Alternative to high flow silica for mid-polar to non-polar compounds (<30000) in crude samples
Environmental (AEV)	Hydrophilic/ Hydrophobic	Reversed Phase	Mid to non-polar compounds	Aqueous or Organic	Aqueous environmental compounds that are not retained on C18	1 – 12	No	70	800	75	Advanced environmental; Polystyrene-co-2-hydroxyethyl methacrylate (PSHEMA)
HLB	Hydrophilic/lipophilic balanced	Reversed Phase	Mid to non-polar compounds	Aqueous or organic	Mid-polar and non-polar compounds in aqueous and organic solvents	0 – 14	No	80	850	30 and 60	Hydrophilic-lipophilic-balanced reversed-phase sorbent for acids, bases and neutrals

Supra-Clean Columns and Cartridges

Supra-Clean SPE products are available in a range of media weights, volumes and formats, including easy to order selection kits and application packs.

- Pure spherical silica
- Pore size 60 – 120 Å
- 17 chemistries with pH range 2 – 8

Columns

Media Weight	Volume	Qty.	Part No.
Supra-Clean C18			
50 mg	1 mL	50	N9306476
100 mg	1 mL	100	N9306478
100 mg	3 mL	50	N9306523
200 mg	3 mL	50	N9306462
500 mg	3 mL	50	N9306438
500 mg	3 mL*	50	N9306642
200 mg	6 mL	30	N9306634
500 mg	6 mL	30	N9306448
500 mg	6 mL*	30	N9306640
1 g	6 mL	30	N9306422
2 g	6 mL	30	N9306430
2 g	15 mL	20	N9306479
2 g	25 mL	20	N9306475
Supra-Clean REC18			
50 mg	1 mL	50	N9306519
100 mg	1 mL	100	N9306520
100 mg	3 mL	50	N9306455
200 mg	3 mL	50	N9306521
500 mg	3 mL	50	N9306522
200 mg	6 mL	30	N9306633
500 mg	6 mL	30	N9306457
1 g	6 mL	30	N9306491
Supra-Clean Strong Anion Exchange (SAX)			
50 mg	1 mL	50	N9306553
100 mg	1 mL	100	N9306471
100 mg	3 mL	50	N9306554
200 mg	3 mL	50	N9306482
500 mg	3 mL	50	N9306555
500 mg	6 mL	30	N9306556

Media Weight	Volume	Qty.	Part No.
Supra-Clean Strong Cation Exchange (SCX)			
50 mg	1 mL	50	N9306536
100 mg	1 mL	100	N9306432
100 mg	3 mL	50	N9306537
200 mg	3 mL	50	N9306538
500 mg	3 mL	50	N9306539
500 mg	6 mL	30	N9306540
Supra-Clean Weak Cation Exchange (WCX)			
50 mg	1 mL	50	N9306544
100 mg	1 mL	100	N9306545
100 mg	3 mL	50	N9306546
200 mg	3 mL	50	N9306547
500 mg	3 mL	50	N9306420
500 mg	6 mL	30	N9306407
Supra-Clean 300Å C4			
50 mg	1 mL	50	N9306590
100 mg	1 mL	100	N9306591
100 mg	3 mL	50	N9306592
200 mg	3 mL	50	N9306593
Supra-Clean Mixed-Mode (MM1)			
50 mg	1 mL	50	N9306541
100 mg	1 mL	100	N9306542
100 mg	3 mL	50	N9306419
200 mg	3 mL	50	N9306543
500 mg	3 mL	50	N9306481
500 mg	6 mL	30	N9306416
200 mg	15 mL	50	N9306713
Supra-Clean Mixed-Mode (MM2)			
50 mg	1 mL	50	N9306548
100 mg	1 mL	100	N9306549
100 mg	3 mL	50	N9306550
200 mg	3 mL	50	N9306551
500 mg	3 mL	50	N9306411
500 mg	6 mL	30	N9306552

Media Weight	Volume	Qty.	Part No.
Supra-Clean Mixed-Mode (MM3)			
500 mg	6 mL	30	N9306649
Supra-Clean Florisil (FL-S)			
200 mg	3 mL	50	N9306511
500 mg	3 mL	50	N9306512
500 mg	6 mL	30	N9306494
1 g	6 mL	30	N9306413
2 g	6 mL	20	N9306513
2 g	15 mL	20	N9306514
2 g	25 mL	20	N9306515
Supra-Clean Florisil (FL-S) Pesticide Grade			
200 mg	3 mL	50	N9306516
500 mg	3 mL	50	N9306400
500 mg	6 mL	30	N9306517
1 g	6 mL	30	N9306436
2 g	6 mL	30	N9306470
2 g	15 mL	20	N9306443
2 g	25 mL	20	N9306447
Supra-Clean Silica (SI-S)			
100 mg	3 mL	50	N9306532
200 mg	3 mL	50	N9306444
500 mg	3 mL	50	N9306402
500 mg	6 mL	30	N9306466
1 g	6 mL	30	N9306404
2 g	6 mL	20	N9306533
2 g	15 mL	20	N9306534
2 g	25 mL	20	N9306535
Supra-Clean Cyano (CN-S)			
500 mg	3 mL	50	N9306645
500 mg	6 mL	30	N9306644
Supra-Clean Amino (NH₂-S)			
50 mg	1 mL	50	N9306528
100 mg	1 mL	100	N9306410
100 mg	3 mL	50	N9306529
500 mg	3 mL	50	N9306414
200 mg	6 mL	50	N9306530
500 mg	6 mL	30	N9306531

Media Weight	Volume	Qty.	Part No.
Supra-Clean Polyamine (P6)			
500 mg	3 mL	50	N9306518
500 mg	6 mL	30	N9306434
Supra-Clean Phenyl (PH-S)			
50 mg	1 mL	50	N9306401
100 mg	1 mL	100	N9306524
100 mg	3 mL	50	N9306525
200 mg	3 mL	50	N9306490
500 mg	3 mL	50	N9306421
500 mg	6 mL	30	N9306526
1 g	6 mL	30	N9306527
Supra-Clean LCC			
500 mg	3 mL	50	N9306643
500 mg	6 mL	30	N9306641

* Not end-capped

Cartridges

Media Weight	Qty.	Part No.
Supra-Clean C18		
390 mg	50	N9306587
910 mg	50	N9306588
1690 mg	50	N9306589
Supra-Clean Silica (SI-S)		
300 mg	50	N9306584
700 mg	50	N9306585
1300 mg	50	N9306586

Supra-Poly HLB Columns

Supra-Poly SPE products are available in a range of media weights, volumes and formats, including glass and Large Reservoir Capacity (LRC) columns.

- Contains macro-porous polymers with ultra-pure, pharmaceutical grade spherical particles
- Shorter analysis times, greater load capacity and reduced solvent usage
- Ideal for high throughput assays

Supra-Poly HLB

Media Weight	Volume	Qty.	Part No.
30 µm Columns			
30 mg	1 mL	50	N9306650
50 mg	1 mL	50	N9306655
60 mg	1 mL	50	N9306656
100 mg	1 mL	50	N9306657
30 mg	3 mL	50	N9306651
60 mg	3 mL	50	N9306658
100 mg	3 mL	50	N9306659
200 mg	3 mL	50	N9306660
500 mg	3 mL	30	N9306661
100 mg	6 mL*	30	N9306672
150 mg	6 mL	30	N9306662
200 mg	6 mL	30	N9306663
200 mg	6 mL*	30	N9306673
500 mg	6 mL*	30	N9306674
500 mg	6 mL	30	N9306664
500 mg	15 mL	20	N9306665
1 g	15 mL	20	N9306666
30 mg	15 mL**	50	N9306668
60 mg	15 mL**	50	N9306669
100 mg	15 mL**	50	N9306670
200 mg	15 mL**	50	N9306671
1 g	25 mL	20	N9306667

Media Weight	Volume	Qty.	Part No.
60 µm Columns			
30 mg	1 mL	50	N9306652
50 mg	1 mL	50	N9306675
60 mg	1 mL	50	N9306676
100 mg	1 mL	50	N9306677
30 mg	3 mL	50	N9306653
60 mg	3 mL	50	N9306678
100 mg	3 mL	50	N9306679
200 mg	3 mL	50	N9306680
500 mg	3 mL	30	N9306681
100 mg	6 mL*	30	N9306692
150 mg	6 mL	30	N9306682
200 mg	6 mL	30	N9306683
200 mg	6 mL*	30	N9306693
500 mg	6 mL	30	N9306684
500 mg	15 mL	20	N9306685
500 mg	6 mL*	30	N9306694
1 g	15 mL	20	N9306686
30 mg	15 mL**	50	N9306688
60 mg	15 mL**	50	N9306689
100 mg	15 mL**	50	N9306690
200 mg	15 mL**	50	N9306691
1 g	25 mL	20	N9306687

* Glass columns
** LRC columns

Supra-Poly Columns

SPE products are available in a range of media weights, volumes and formats, including easy to order selections and application packs.

- Contains macro-porous polymers with ultra-pure, pharmaceutical grade spherical particles
- Shorter analysis times, greater load capacity and reduced solvent usage
- Ideal for high throughput assays

Supra-Poly Extreme Capacity 1500 m²/g (XC)

Media Weight	Volume	Qty.	Part No.
Columns			
30 mg	1 mL	50	N9306441
50 mg	1 mL	50	N9306500
60 mg	1 mL	50	N9306501
100 mg	1 mL	50	N9306403
60 mg	3 mL	50	N9306502
100 mg	3 mL	50	N9306440
200 mg	3 mL	50	N9306428
200 mg	6 mL	30	N9306635
500 mg	6 mL	30	N9306405
1 g	15 mL	20	N9306503

Supra-Poly Extra Wide Particle 1200 m²/g (XWP)

Media Weight	Volume	Qty.	Part No.
Columns			
30 mg	1 mL	50	N9306504
50 mg	1 mL	50	N9306427
60 mg	1 mL	50	N9306505
100 mg	1 mL	50	N9306506
60 mg	3 mL	50	N9306507
100 mg	3 mL	50	N9306508
200 mg	3 mL	50	N9306509
500 mg	6 mL	30	N9306418
1 g	15 mL	20	N9306510

Supra-Poly Environmental (AEV)

Media Weight	Volume	Qty.	Part No.
Columns			
100 mg	3 mL	50	N9306648

Supra-Poly Hydrophilic (ATH)

Media Weight	Volume	Qty.	Part No.
Columns			
100 mg	3 mL	50	N9306646
200 mg	3 mL	50	N9306638
200 mg	6 mL	30	N9306636

Supra-Poly Lipophilic (ATL)

Media Weight	Volume	Qty.	Part No.
Columns			
100 mg	3 mL	50	N9306647
200 mg	3 mL	50	N9306639
200 mg	6 mL	30	N9306637

Compared to other industry-leading SPE materials, our Extreme Capacity (XC) and Extra Wide Particles (XWP) lead market in surface area. This allows for higher capacities at lower bed weights.

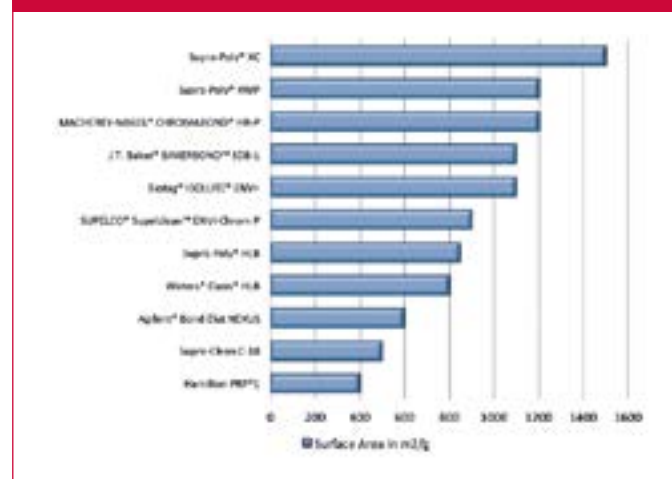

Supra-d QuEChERS Dispersive SPE

For more than 30 years, pesticide extraction methods have evolved to ensure rugged and safe liquid chromatography (LC) or gas chromatography (GC) analysis. Initial techniques of liquid to liquid extraction and Dispersive SPE (dSPE) have been optimized to combat emulsions, loss of analytes and excessive solvent consumption.

Our Supra-d QuEChERS dispersive SPE turns sample preparation into an easy two-step process by using the QuEChERS method. QuEChERS (Quick, Easy, Cheap, Effective, Rugged, Safe) dispersive SPE, is the number one used sample preparation approach in pesticide residue analysis. It eliminates complex liquid extraction methods and extends the range of recovered pesticides. The QuEChERS procedure is fast and easy, improving lab productivity and resulting in fewer errors.

Features and Benefits:

- High recoveries are achieved for more accurate analyzes
- Up to 4 times faster than traditional methods
- Low solvent usage and waste for maximum cost savings



Our SPE extraction and clean-up kits have been customized for your specific sample preparation needs. They are designed for both steps of the QuEChERS method and each kit includes pre-prepared products for simplicity and error-free extractions. A certificate of quality is included in each kit, ensuring you have the best for your application. With our extensive line of dispersive SPE kits you'll be sure to find what you're looking for.

QuEChERS simple two-step procedure:

Step 1: Extraction

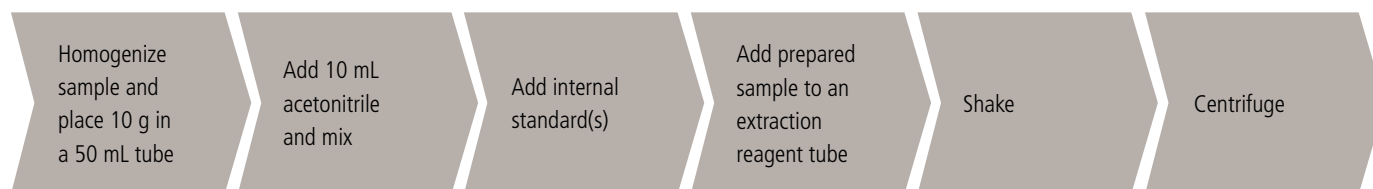

Step 2: Clean-Up

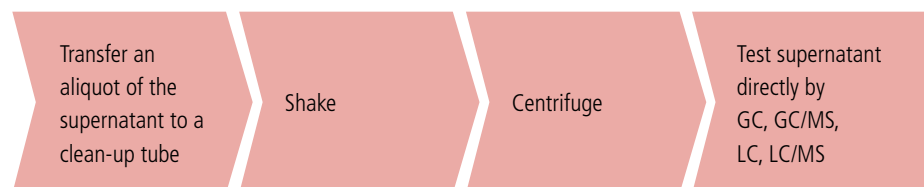

Supra-d QuEChERS for Multiple Pesticide Residue Analysis

We provide a complete range of products for QuEChERS methodologies, offering all three standard QuEChERS methods: Original QuEChERS method, American AOAC Standard (Official Method 2007.01) QuEChERS method and European Standard (EN 15662) QuEChERS method. View our varieties of extraction and clean-up kits below for added convenience.



Method	Vol.	Qty.	MgSO ₄	Na Acetate	Na Citrate	Na Citrate Sesquihydrate	NaCl	Part No.	Empty Tube Part No.	Powder Pack (pkg. 50) Part No.	Powder Pack (pkg. 500) Part No.
Extraction Kits											
AOAC 2007.01	50 mL	50	6 g	1.5 g				N9306900	N9306935	N9306936	N9306939
EN 15662	50 mL	50	4 g		1 g	0.5 g	1 g	N9306901	N9306935	N9306937	N9306940
Original	50 mL	50	4 g				1 g	N9306902	N9306935	N9306938	N9306941
Description	Vol.	Qty.	MgSO ₄ *	PSA**	C18***	PGC****	Part No.				
AOAC 2007.01 Clean-Up Kits											
Fruit and Vegetables	2 mL	100	150 mg	50 mg			N9306908				
Fruit and Vegetables	15 mL	50	1200 mg	400 mg			N9306909				
Fruit and Vegetables with Fats and Waxes	2 mL	100	150 mg	50 mg	50 mg		N9306910				
Waxed Fruit and Vegetables	15 mL	50	1200 mg	400 mg	400 mg		N9306911				
Pigmented Fruit and Vegetables	15 mL	50	1200 mg	400 mg		400 mg	N9306912				
Fruit and Vegetables with Pigments and Fats	2 mL	100	150 mg	50 mg	50 mg	50 mg	N9306913				
Fruit and Vegetables with Pigments and Fats	15 mL	50	1200 mg	400 mg	400 mg	400 mg	N9306914				
EN 15662 Clean-Up Kits											
Fruit and Vegetables	2 mL	100	150 mg	25 mg			N9306920				
Fruit and Vegetables	15 mL	50	900 mg	150 mg			N9306921				
Fruit and Vegetables with Fats and Waxes	2 mL	100	150 mg	25 mg	25 mg		N9306922				
Waxed Fruit and Vegetables	15 mL	50	900 mg	150 mg	150 mg		N9306923				
Pigmented Fruit and Vegetables	15 mL	50	900 mg	150 mg		15 mg	N9306924				
Pigmented Fruit and Vegetables	2 mL	100	150 mg	25 mg		2.5 mg	N9306925				
High Pigmented Fruit and Vegetables	2 mL	100	150 mg	25 mg		7.5 mg	N9306926				
High Pigmented Fruit and Vegetables	15 mL	50	900 mg	150 mg		45 mg	N9306927				
Description	Method	Vol.	Qty.	MgSO ₄ *	PSA**	C18***	PGC****	Part No.			
Clean-up Kit											
Clean-up Kit	Original	15 mL	50	900 mg	300 mg		150 mg	N9306933			

* MgSO₄ removes excess water.

** PSA removes sugars, fatty acids, organic acids, and anthocyanine pigments.

*** C18 removes nonpolar interferences.

**** PGC (carbon) removes pigments, sterols, and nonpolar interferences.

SPE Application and Selection Packs

SPE Application Packs

Ideal for extraction of known entities from a variety of matrices, our packs are expertly tailored to meet your application needs and are designed to support major EPA methods and applications.

Description	Media Weight	Volume	Qty.	Part No.
Extraction of Basic Drugs from Biological Fluids	200 mg	3 mL	50	N9306605
Extraction of Bisphenol A from Aqueous Matrix	1 g	6 mL	30	N9306613
Extraction of Oil and Grease from Aqueous Matrix-EPA 1664	500 mg	3 mL	50	N9306612
	1 g	6 mL	30	N9306611
Extraction of PAH from Soil and Oil	1.5 g	6 mL	30	N9306609
Extraction of PAH from Soil and Oil (Glass Straight Column)	1.5 g	6 mL	30	N9306610
Extraction of PAH from Water Containing Humic Acids	1.5 g	6 mL	30	N9306608
Extraction of PAH from Water or Soil	4 g	6 mL	30	N9306606
Extraction of PAH from Water or Soil (Glass Straight Column)	4 g	6 mL	30	N9306607
Extraction of PCB from Oil	1 g	6 mL	30	N9306617
	1 g	3 mL	50	N9306616
Extraction of Pesticides and Herbicides from Aqueous Matrix	500 mg	3 mL	50	N9306614
Extraction of Steroids from Biological Fluids	500 mg	6 mL	30	N9306615
Extraction of SVOC from Water-EPA 525	1 g	6 mL	30	N9306618

SPE Selection Packs

Enables quick column selection for development of reproducible and repeatable SPE methods.

Description	Media Weight	Volume	Qty.	Part No.
Pre-Concentration of Hydrophobic Compounds from Aqueous Matrix	200 mg	6 mL	50	N9306594
	200 mg	3 mL	50	N9306595
Extraction of Hydrophobic Compounds from Aqueous Matrix	500 mg	6 mL	50	N9306596
	500 mg	3 mL	50	N9306597
Pre-Concentration of Hydrophilic Compounds	500 mg	6 mL	30	N9306598
	500 mg	3 mL	30	N9306599
Removal of Polar Compounds from Aqueous and Organic Matrix	500 mg	6 mL	30	N9306600
	500 mg	3 mL	30	N9306601
Extraction of Acidic Basic and Neutral Compounds from Aqueous or Organic Matrix	100 mg	3 mL	50	N9306602
Extraction of Carboxylic Acids and Strong Bases from Aqueous Matrix	500 mg	6 mL	40	N9306603
Extraction of Weak Bases from Aqueous Matrix	500 mg	6 mL	30	N9306604

SPE Vacuum PUMPS, Manifolds and Accessories

SPE Vacuum Manifolds accommodate either 12 or 24 cartridges; 1, 3, 6, 15, and 25 mL columns can be used. Manifolds are equipped with a vacuum port to connect a standard laboratory vacuum pump. Vacuum pulls the sample through the stationary phase, metered by the stopcocks, to control the speed of the extraction process and the sample flow. Waste and wash solvents are discarded and analytes are collected in sample tubes below the manifold completing the extraction. For your convenience, manifold kits are supplied in either 12 position or 24 position configurations.



Kit Contents

Description	Qty.	12 Position Part No.	Qty.	24 Position Part No.
Vacuum Manifold Kit	1	N9306619	1	N9306626
Replacement Chamber (Glass)	1	N9306620	1	N9306627
Cover Gasket – 12 Position	1	N9306621	1	N9306628
Stopcocks – 12 Position	12	N9306624	24	N9306631
Needles – Polypropylene	12	N9306622	24	N9306629
Needles – Stainless Steel	12	N9306623	24	N9306630
Drying Attachment	1	N9306625	1	N9306632

Description	Qty.	20 L/min 115 V	60 L/min 115 V	17 L/min 230 V	58 L/min 230 V
Vacuum Pumps	1	N9308035	N9308063	N9308331	N9308332

Syringes

Disposable Syringes

Designed for use with syringe filters, these disposable, sterile, polypropylene syringes are for general-purpose applications. Our package design features an airtight seal that's easy to open. Upon removing, the syringes can be autoclaved effortlessly.

Description	Pkg.	Part No.
Luer-Lock Tips, 1 mL	100	02542890
Luer-Lock Tips, 3 mL	200	02542891
Luer-Lock Tips, 5 mL	100	02542892
Luer-Lock Tips, 10 mL	100	02542893

Ultramicro Volume Syringes

Recommended for manual liquid sample injections of less than 5 µL for gas chromatography. Syringes come standard with needle length of 7 cm – optimal for PerkinElmer injectors.

Syringe Capacity	Gauge	OD	ID	Tip Description	Pkg.	Part No.
0.5 µL	26	0.47	0.1	Bevel	1	N9302231
1.0 µL	23	0.63	0.15	Cone	1	00230177
1.0 µL	26*	0.47	0.15	Cone	1	00230111
2.0 µL	23	0.63	0.12	Bevel	1	N9302235
5.0 µL	23	0.63	0.37	Cone	1	00230178

* Recommended for PerkinElmer wide-bore capillary adapter.

Nylon and PTFE Syringe Filters



Our Syringe Filters are lab tested and certified to bring you the highest quality syringe filters available. Our membrane materials are supplied per ISO9001:2008 certified manufacturing practices in certified clean room conditions. We utilize the latest manufacturing technology to ensure you receive a high quality, consistent product every time.

Select our superior premium 17 and 30 mm filters which are suitable for coarse/crude samples or higher detection limit applications (such as food, beverage, or environmental analysis) and our 4, 13 and 25 mm syringe filters are ideal for routine QA/QC analysis.

Nylon Syringe Filters

Ideal for aqueous (non-acidic) or organic sample preparation and HPLC, GC or dissolution sample analysis. With its excellent flow characteristics, very low extractable levels and mechanical stability, Nylon offers the best combination of physical parameters to meet the most stringent analytical needs.

Size (mm)	Pkg.	Color	0.22 μ m Particle Part No.	0.45 μ m Particle Part No.
4	200	Clear	02542900	02542901
13	100	Purple	02542902	02542903
17	100	Yellow	02542881	02542880
25	100	Purple	02542904	02542905
30	100	Yellow	02542883	02542882

PTFE (Hydrophobic) Syringe Filters

These are versatile filters for use with aggressive organic solvent-based solutions and are particularly suited for HPLC sample preparation. Hydrophobic PTFE syringe filters have broad chemical compatibility and high pH resistance.

Size (mm)	Pkg.	Color	0.22 μ m Particle Part No.	0.45 μ m Particle Part No.
4	200	Clear	02542906	02542907
13	100	Red	02542908	02542909
17	100	Red	02542884	02542910
25	100	Red	02542911	02542912
30	100	Red	02542886	02542885

PVDF (Hydrophobic Polyvinylidene Fluoride) Syringe Filters

Compatible with a wide range of mild organic solutions. PVDF membranes are not recommended for use with acetone, DMF, DMSO, or bases >6N.

Size (mm)	Pkg.	Color	0.22 μ m Particle Part No.	0.45 μ m Particle Part No.
4	200	Clear	02542913	02542914
13	100	Yellow	02542915	02542783
17	100	Maroon	02542916	02542917
25	100	Yellow	02542918	02542919
30	100	Maroon	02542920	02542921

PTFE (Hydrophilic) Syringe Filters

These filters are suitable for use with aqueous and aggressive organic solvent-based solutions and are suitable for HPLC sample preparation. They have broad chemical compatibility and high pH resistance.

Size (mm)	Pkg.	Color	0.22 μ m Particle Part No.	0.45 μ m Particle Part No.
4	200	Clear	02542922	02542923
13	100	Red	02542924	02542925
25	100	Red	02542926	02542927
30	100	Red	02542928	02542929

Vials, Caps and Septa

PerkinElmer offers a wide selection of superior quality products designed to work with your PerkinElmer instruments. Our precision designed products deliver the peace of mind that comes from knowing that you'll get the results you need.

Quick Reference Index

Page

➤ Autosampler Caps and Septa	33
➤ Autosampler Vial, Cap and Septa Convenience Kits	27
➤ Autosampler Vials	22
➤ Autosampler Vial Inserts	26
➤ Autosampler High Recovery Vials	25
➤ Autosampler Vials with Fused Inserts	25
➤ Autosampler Caps with Ultra Low Bleed Septa	34
➤ Crimpers: Electronic, Handheld and Benchtop	36
➤ CTC Headspace Vials	30
➤ Headspace Caps and Septa	35
➤ Headspace Caps with Ultra Low Bleed Septa	34
➤ Headspace Crimp Top Vials	28
➤ Headspace Screw Top Vials	28
➤ Headspace Starter Kits	32
➤ Headspace Vial, Cap and Septa Convenience Kits	31
➤ How to Choose a Vial and Seal	19
➤ PureView Certified and MS Certified Vials	19
➤ Quality Matters; Vials, Caps and Septa	18
➤ Waste and Wash Vials, Caps and Septa for GC	26

PureView Certified and MS Certified Vials

Our range of PureView Certified and MS Certified vials are manufactured from Type 1 borosilicate glass which meets all USP, JP, and EP requirements. PureView MS Certified vials have been thoroughly tested for residuals and approved on Mass Spec (MS) systems.



➤ [VIEW PAGE](#)

Vial, Cap and Septa Kits

Buying a kit offers you a guaranteed proper fit between the cap and vial. Available with either glass or polypropylene vials, and a range of cap choices, these autosampler vial, cap and septa kits make it surprisingly simple to re-stock your laboratory.



➤ [VIEW PAGE](#)

Fused Inserts Autosampler Vials

For easy handling and sampling of micro volumes, try our glass vials with fused sample inserts. A variety of volumes are available in either clear or amber glass.



➤ [VIEW PAGE](#)

Electronic Crimpers

The upgraded electronic crimper and decapper model features a new digital display that indicates tool size, remaining battery power, current crimp setting, and the cycle result. The settings menu provides tool statistics, a cycle log, reset options, and language settings. Benefit from consistent crimp power time and time again at the touch of a button.



➤ [VIEW PAGE](#)

➤ [BACK TO MAIN INDEX](#)

➤ [ORDER ONLINE](#)

➤ [CLICK THE ARROWS TO VIEW EACH PAGE](#)

VIALS

WASTE AND WASH VIALS

HS VIALS

CAPS AND SEPTA

HS CAPS AND SEPTA

CRIMPERS

Quality Matters: Vials, Caps and Septa

Vials and closures are a critical part of your workflow; just as important as the instrument or column used. It is easy to think of a vial or cap as a low cost commodity that won't impact your results, but the reality is different. It's not only the physical attributes that can affect overall analytical performance, but also the quality of the glass and septa used. Contamination from sub-standard glass or poor quality septa (Figure 3) can lead to interferences, inaccuracies and failures which ultimately effects lab productivity.

Figure 3. Bonded Cap Analysis.

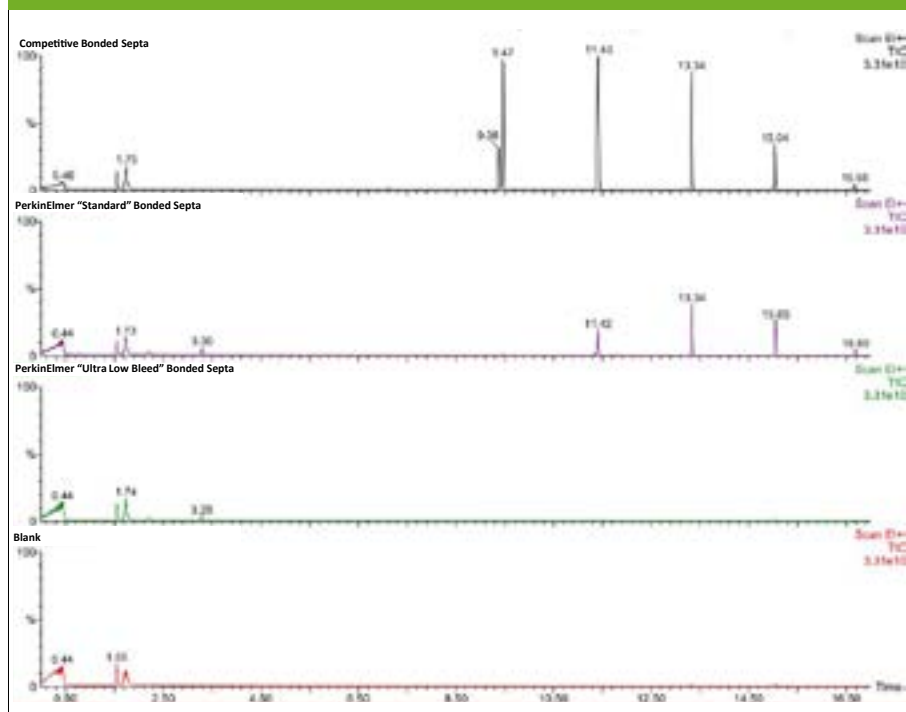

Features and Benefits:

- Vials are made from Type I Borosilicate Glass; which meets all USP, JP and EP requirements. This glass is very hard and has a low expansion coefficient even at high temperature
- Vials are stringently tested using camera gauging technology to ensure final product meets all dimensional specifications
- All our vials, caps and septa are fit to perform on PerkinElmer and non-PerkinElmer instruments
- We stock a wide variety of sizes, colors and materials of vials, caps and septa
- All vials are packed in a clean room and those labelled with 'LC Clean' include an additional certificate of analysis
- Option for ultra low bleed septa for the ultimate in inertness. Batch certification is also available

The GC comparison, above, compares a competitive brand of septa to PerkinElmer's standard and ultra-low bleed septa products. The level of siloxanes bleed identified in the competitive product is clearly at a much higher level compared to our septa.

Taking purity and inertness to the next level are PerkinElmer's range of ultra low bleed septa. Offering unsurpassed quality, no bleed is detected ensuring maximum sensitivity for applications; particularly MS, headspace and SPME.

You can rely on PerkinElmer to consistently supply only the highest quality vials, caps and septa to ensure that your analytical instruments continue to operate smoothly. All are tested to our stringent requirements and are compatible with both PerkinElmer instruments and other vendor systems. Choose from a range of glass or polypropylene vials and select your particular closure from a variety of options. Separate vials and caps can readily be purchased or select one of our kits for added convenience.

How to Choose a Vial:

1. Choose a size.

- Volume (i.e. 2 mL, high recovery or micro volume)
- Diameter and height (i.e. 12 mm x 32 mm)
- ID of the neck (i.e. 9 mm or 11 mm)
- Finish (i.e. crimp or screw top)



2. Choose a color.

If your sample is sensitive to light you may want to consider an amber vial.

3. Choose a material.

Vials are available in both glass and polypropylene. For biological applications polypropylene vials are recommended.

How to Choose a Seal:

1. Choose a septa material.

Required temperature of operation, resistance to coring, storage shelf time are a few of the variables that should be taken into consideration when choosing your septa material. Refer to the table below for an overview of compatibility.



2. Decide between a pre-slit or non-slit septa.

Due to the technique and type of needle they use, pre-slit septa are ideal for LC systems, while non-slit septa are ideal for GC and GC/MS systems.

3. Match the size of the cap/septa with the size of your vial.

Cap and Septa Compatibility

	PTFE/Silicone	PTFE/Red Rubber	PTFE/Red Butyl	Red Butyl
Temperature range	Up to 210 °C	Up to 160 °C	Up to 130 °C	Up to 130 °C
Use for multiple injections?	Yes	Yes	No	No
Price per 1000	Expensive	Economical	Economical	Very Economical
Resistance to coring	Excellent	Good	Low	Low
Recommended for storage	Yes	Yes	No	No
Solvent Compatibility				
Acids	Excellent	Good	Fair	Fair
Alcohols	Good	Fair	Good	Good
Chloroform	Good	Poor	Fair	Fair
Ethyl acetate	Excellent	Good	Fair	Fair
Hexane	Good	Poor	Poor	Poor
Methanol	Excellent	Good	Good	Good

Do You Need Anything Else?

We have a wide variety of crimpers, decappers, and vial trays to also make your analysis easier.

PureView Certified and MS Certified Vials

It's a common misconception that all vials are created equal. In fact, their quality and cleanliness can vary significantly. Many people think vials and caps are an inexpensive commodity that won't impact your results, but that's not the case.

Vials and closures are a critical part of your daily workflow – they're as important as the instruments and columns you trust to get accurate results day after day. Not only do their physical attributes affect overall analysis, but also their quality of glass and septa play a key role in your outcomes. Contamination from substandard glass or poor-quality septa can lead to interferences, inaccuracies, and failures, which ultimately drags down lab productivity.



PureView Certified Vials

Our range of certified vials are manufactured from Type 1 borosilicate glass which meets all USP, JP, and EP requirements. The low-expansion, coefficient glass exhibits excellent thermal conductivity and provides an inert surface with a low free ion content, giving you accurate results every time.

Produced to our exacting tolerances to facilitate uninterrupted analysis and minimize unplanned downtime, no product is placed into inventory without passing cleanliness and performance testing for consistent results.

Packaged in an ISO class 8 clean room environment, there is no risk of organic contaminants, helping to maintain analysis sensitivity levels.

PureView MS Certified Vials

Vials and caps are a critical part of a sample workflow and can be overlooked in any out of specification investigation where inaccurate peaks occur. Lower quality vials and caps can be a source of sample contamination. Our range of PureView MS certified vials and range of caps, including the ultralow bleed septa, have been thoroughly tested for residuals and approved on Mass Spec (MS) systems. So, you can have complete confidence in your results and minimize unplanned laboratory downtime. Residuals testing by GC/MS and LC/MS is completed on every batch of PureView MS certified vials by replicating typical user conditions. Vials are exposed to commonly used solvents and at given time intervals. This enables confirmation that there is a low background, ensuring maximum sensitivity. An example of clear PureView MS Certified vials analyzed at 2-hour and 5-day intervals is shown on GCMS and LCMS below.

PureView Certified and MS Certified vials are available in 2 mL autosampler and 20 mL headspace vials. For added convenience and a guaranteed fit, a number of vial and cap kits are also available.

> 2 mL Autosampler Vials

> 20 mL Headspace Vials

> BACK TO SECTION INDEX

> BACK TO MAIN INDEX

> ORDER ONLINE

GC/MS TIC scans of PureView MS Certified clear vials with DCM (blank, 2-hour extraction, 5-day extraction).

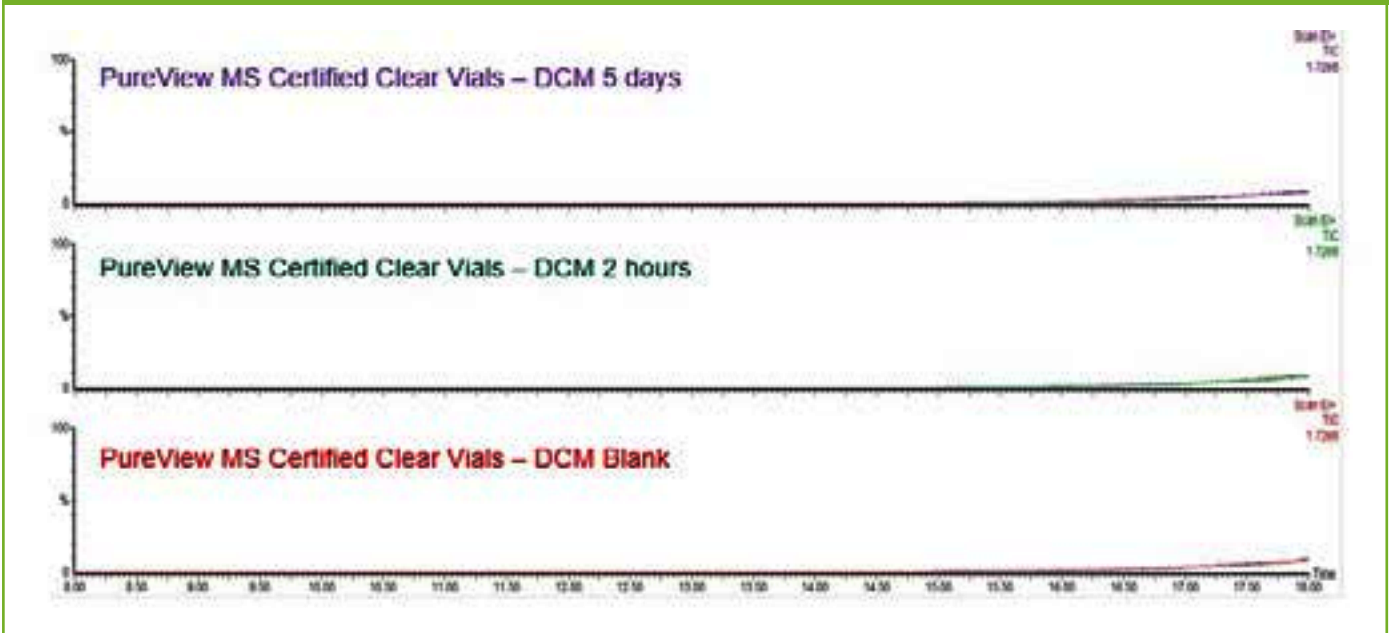

LC/MS (+) and (-) TIC scans of PureView MS Certified clear vials with ACN (blank, 2-hour extraction, 5-day extraction).

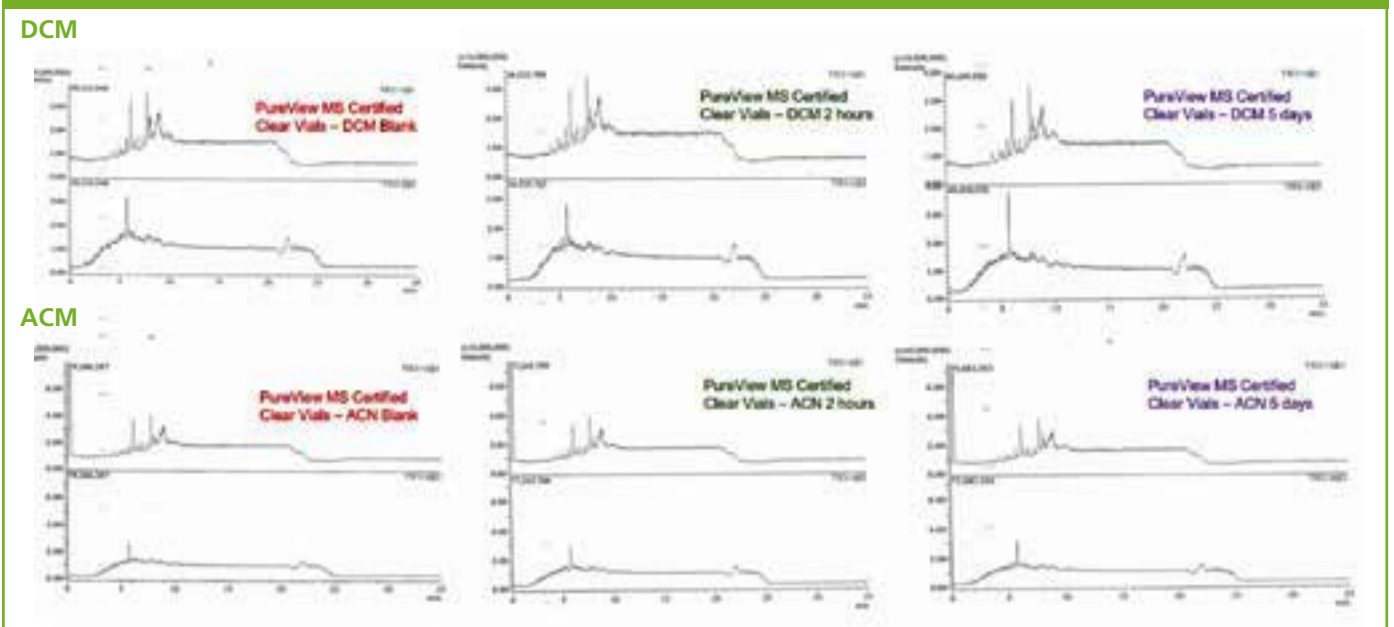

PureView Certified and MS Certified 2 mL Autosampler Vials

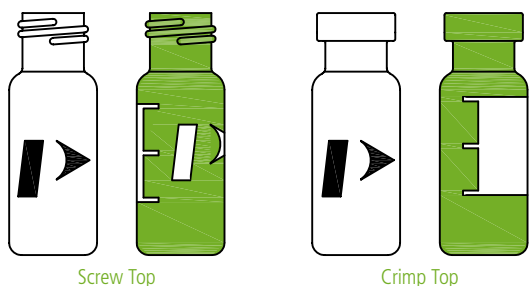

PureView 2 mL Autosampler Glass Vials (12 x 32 mm)

Our range of PureView Certified and MS Certified vials are manufactured from Type 1 borosilicate glass which meets all USP, JP, and EP requirements. PureView MS Certified vials have been thoroughly tested for residuals and approved on MS systems.

Select from a range of crimp or screw vials, in amber or clear glass. All certification details are available at www.perkinelmer.com/COA where you simply enter the part number and lot number to retrieve the information.

	Clear Screw	Clear Screw Write on Patch	Amber Screw Write on Patch	Clear Crimp Write on Patch	Amber Crimp Write on Patch
Neck Diameter	9 mm	9 mm	9 mm	11 mm	11 mm
Vial Dimensions	12 x 32 mm	12 x 32 mm	12 x 32 mm	12 x 32 mm	12 x 32 mm

PureView Certified 2 mL GC and LC Vials

Crimp vials are commonly used for GC and screw vials commonly used for LC, but either crimp or screw configurations can be used.

	Clear Screw	Clear Screw Write on Patch	Amber Screw Write on Patch	Clear Crimp Write on Patch	Amber Crimp Write on Patch
Part Number Pkg. 100	N9305087	N9305088	N9305089	N9305085	N9305086
Part Number Pkg. 1,000	N9305097	N9305098	n/a	N9305095	N9305096

PureView MS Certified 2 mL GC and LC Vials

Crimp vials are commonly used for GC and screw vials commonly used for LC, but either crimp or screw configurations can be used.

	Clear Screw	Clear Screw Write on Patch	Amber Screw Write on Patch	Clear Crimp Write on Patch	Amber Crimp Write on Patch
Part Number Pkg. 100	N9305077	N9305078	N9305079	N9305075	N9305076
Part Number Pkg. 1,000	N9305101	N9305102	n/a	N9305099	N9305100

See next page for PureView 2 mL Autosampler Vial Instrument Compatibility.

	Clear Screw	Clear Screw Write on Patch	Amber Screw Write on Patch	Clear Crimp Write on Patch	Amber Crimp Write on Patch
					
Neck Diameter	9 mm	9 mm	9 mm	11 mm	11 mm
Vial Dimensions	12 x 32 mm	12 x 32 mm	12 x 32 mm	12 x 32 mm	12 x 32 mm

PureView 2 mL Headspace Vial Instrument Compatibility

Manufacturer		2 mL Clear Screw Vial	2 mL Clear Screw Vial with Write on Patch	2 mL Amber Screw Vial with Write on Spot	2 mL Clear Crimp Vial with Write on Spot	2 mL Amber Crimp Vial with Write on Spot
PerkinElmer	Flexar LC/Series 200	✓	✓	✓	✓	✓
	Clarus GC 400 Series/500 Series/600 Series	✓	✓	✓	✓	✓
Thermo Scientific/Dionex	AS100/AS200/AS300/AS150/AS800 (LC)	✓	✓	✓	✓	✓
	AS 1000/2000/3000 (TRACE GC)	✓	✓	✓	✓	✓
	AS-AP	✓	✓	✓	✓	✓
	SURVEYOR Autosampler Plus	✓	✓	✓	✓	✓
	WPS-3000RS/3000SL	✓	✓	✓	✓	✓
Agilent Technologies	1050	✓	✓	✓	✓	✓
	1050 (34 Position Tray)*	-	-	-	-	-
	1090	✓	✓	✓	✓	✓
	1100	✓	✓	✓	✓	✓
	1200	✓	✓	✓	✓	✓
	1260/1290 Infinity	✓	✓	✓	✓	✓
	7673A/7683A	✓	✓	✓	✓	✓
	5880/5890	✓	✓	✓	✓	✓
	6850 (27 Position Tray Only)/6890	✓	✓	✓	✓	✓
	7890	✓	✓	✓	✓	✓
	8890	✓	✓	✓	✓	✓
	CTC GC PAL	✓	✓	✓	✓	✓
	7673A/7683A/7693A	✓	✓	✓	✓	✓
Waters	ACQUITY™ UPLC	✓	✓	✓	-	-
	Alliance 2690/2695	✓	✓	✓	✓	✓
	Alliance 2790/2795	✓	✓	✓	✓	✓
Shimadzu	AOC14/1400	✓	✓	✓	✓	✓
	AOC 17	✓	✓	✓	✓	✓
	AOC-20/20i/20s (150 Position Tray)	✓	✓	✓	✓	✓
	AOC 88/9	✓	✓	✓	✓	✓
	AOC-5000	✓	✓	✓	✓	✓
	LC 20A	✓	✓	✓	✓	✓
	LC 2010 /LC2010A (140 Position Tray)	✓	✓	✓	✓	✓
	SIL-2AS/SIL-6A/SIL-6B/SIL-7A/SIL-8A/SIL-9A	✓	✓	✓	✓	✓
	SIL-10A/SIL-10AF/SIL-10Ai/SIL-10AxL (100 Position Tray)	✓	✓	✓	✓	✓
	SIL-20A (Prominence) 105 Vial Position Tray	✓	✓	✓	✓	✓
	SIL-20AC (Prominence) 70 Vial Position Tray	✓	✓	✓	✓	✓
	SIL-20AXR/SIL-20ACXR	✓	✓	✓	✓	✓
	SIL-30AC	✓	✓	✓	✓	✓

Standard 2 mL Autosampler Vials

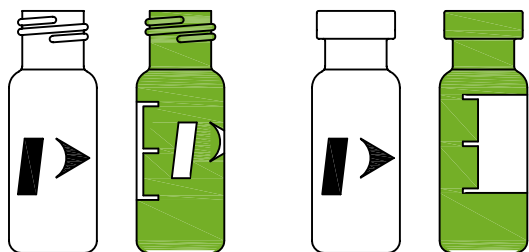

Standard 2 mL Autosampler Glass Vials (12 x 32 mm)

Our standard vials are manufactured from Type I Borosilicate Glass, which meets all USP, JP, and EP Pharmacopeia requirements. The glass performs excellently at high temperatures and is chemical resistant to acidic, neutral and alkali solutions.

Standard 2 mL Autosampler Vials for GC

The vials listed below are the commonly used configurations for GC and are compatible with GC auto samplers. Crimp vials are commonly used, but crimp or screw configurations can be used.

Neck ID Size (mm)	Vial Top Type	Vial Description	Part No. Pkg. 100
9	Screw	Clear glass	N9306201
9	Screw	Clear glass with write on patch and fill lines	N9307801
9	Screw	Clear glass with write on patch (deactivated)	N9304139
9	Screw	Amber glass	N9306220
9	Screw	Amber glass with write on patch and fill lines	N9307802
9	Screw	Amber glass with write on patch and fill lines (deactivated)	N9304140
11	Crimp	Clear glass	N9301385
11	Crimp	Clear glass with write on patch and fill lines	N9306223
11	Crimp	Amber glass	N9302680
11	Crimp	Amber glass with write on patch and fill lines	N9302679

Standard 2 mL Autosampler Vials for LC

The vials listed below are the commonly used configurations for LC and are compatible with LC auto samplers. Screw vials are commonly used, but crimp or screw configurations can be used.

Neck ID Size (mm)	Vial Top Type	Vial Description	Part No. Pkg. 100
9	Screw	Clear glass	N9306201
9	Screw	Clear glass with write on patch and fill lines	N9307801
9	Screw	Clear glass with write on patch (deactivated)	N9304139
9	Screw	Amber glass	N9306220
9	Screw	Amber glass with write on patch and fill lines	N9307802
9	Screw	Amber glass with write on patch and fill lines (deactivated)	N9304140
11	Crimp	Clear glass with write on patch and fill lines (deactivated)	N9304135
11	Crimp	Amber glass with write on patch and fill lines (deactivated)	N9304136

1.5 mL LC Autosampler High Recovery Vials

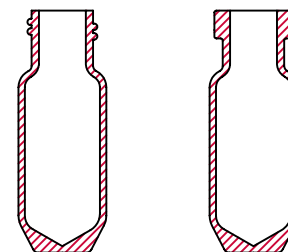

Screw Top

Crimp Top

Manufactured from the same high quality Type 1 Class A borosilicate glass as our standard 2 mL vials, these high recovery vials provide efficient handling of a range of sample volumes from 30 µL to 1.5 mL, with the convenience of a single vial format.

Neck ID Size (mm)	Vial Top Type	Vial Description	Part No. Pkg. 100
9	Screw	Clear glass	N2926202
11	Crimp	Clear glass	N2926200

Micro Volume Autosampler Vials

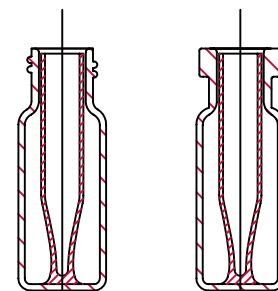

Screw Top

Crimp Top

For easy liquid sampling, try our glass vials with fused sample inserts; a variety of volumes are available in either clear or amber glass. They are ideal when handling micro volume samples.

Neck ID size (mm)	Capacity	Vial Top Type	Vial Description	Part No. Pkg. 100
9	300 µL	Screw	Clear glass	N9300715
9	300 µL	Screw	Amber glass	N9300716
11	300 µL	Crimp	Clear glass	N9300709
11	300 µL	Crimp	Amber glass	N9300710

Autosampler Vial Inserts



Flat Bottom Insert



Precision Point Insert



Our vial inserts are made from the same Type 1 borosilicate glass as our vials and can be used for maximum sample extraction when handling micro volumes. Extend the usability of your Standard or PureView 2 mL vials with the addition of a micro volume insert. Simply select the vial insert that matches with the neck ID of your vial.

Insert Capacity	Insert Dimension (mm)	Fits Vial Neck ID (mm)	Part No. Pkg. 100
250 µL	6 x 29 spring bottom	9 or 11	N9300703
400 µL	6 x 31 flat bottom	9 or 11	N9300704

Waste and Wash Vials, Caps and Septa for GC

ID Size (mm)	Product Description	Screw	Screw	Screw
		Part No. Pkg. 1	Part No. Pkg. 100	Part No. Pkg. 1000
13	Clear Glass Vial – 4 mL (15 x 45 mm)	09923031	N9306247	–
	200 µL Vial Insert	–	–	N9302681
	Support for Vial Insert	–	–	N9302682*
13	Black Cap with PTFE/Silicone (Ultra Low Bleed) Septa	–	N9304141	N9304142
13	Black Phenolic Cap (no Septa)	09923032	–	–
13	Silicone Septa (no Cap)	–	N9302780**	–
	Vial Diffuser	N6101276	–	–

*N9302682 is pkg. 500.

**N9302780 is pkg. 50.

Autosampler Vial, Cap and Septa Convenience Kits

Available with either glass or polypropylene vials and a range of cap choices, these autosampler vial, cap and septa kits make it surprisingly simple to re-stock your laboratory. Crimp vials are commonly used for GC and screw vials commonly used for LC, but either crimp or screw configurations can be used.

For your added convenience, and guaranteed fit, we have compiled some commonly used vial and cap combinations to help you quickly and easily restock your laboratory.



PureView Certified 2 mL Vial, Cap and Septa Convenience Kits for LC and GC

Crimp vials are commonly used for GC and screw vials commonly used for LC, but either crimp or screw configurations can be used.

ID Size (mm)	Vial Neck Type	Vial Type	Cap Type	Septa Type	Part No. Pkg. 100
9	Screw	Clear Glass (Write on Patch)	Blue Cap	Red PTFE/White Silicone (Pre-Slit)	N9310075
9	Screw	Amber Glass (Write on Patch)	Blue Cap	Red PTFE/White Silicone (Pre-Slit)	N9310076
11	Crimp	Clear Glass (Write on Patch)	Aluminum (Silver) Cap	PTFE/Red Rubber	N9310077
11	Crimp	Amber Glass (Write on Patch)	Aluminum (Silver) Cap	PTFE/Red Rubber	N9310078

PureView MS Certified 2 mL Vial, Cap and Septa Convenience Kits for LC and GC

Crimp vials are commonly used for GC and screw vials commonly used for LC, but either crimp or screw configurations can be used.

ID Size (mm)	Vial Neck Type	Vial Type	Cap Type	Septa Type	Part No. Pkg. 100
9	Screw	Clear Glass	Blue Cap	Red PTFE/White Silicone (Pre-Slit)	N9310052
9	Screw	Clear Glass (Write on Patch)	Blue Cap	Red PTFE/White Silicone	N9310053
9	Screw	Clear Glass (Write on Patch)	Blue Cap	Bonded Red PTFE/White Silicone (Pre-Slit)	N9310066
9	Screw	Clear Glass (Write on Patch)	Blue Cap	Bonded Red PTFE/White Silicone	N9310067
9	Screw	Clear Glass (Write on Patch)	Blue Cap	PTFE/White Silicone ULB*	N9310064
9	Screw	Amber Glass (Write on Patch)	Blue Cap	Red PTFE/White Silicone (Pre-Slit)	N9310054
9	Screw	Amber Glass (Write on Patch)	Blue Cap	Red PTFE/White Silicone	N9310055
11	Crimp	Clear Glass (Write on Patch)	Aluminum (Silver) Cap	PTFE/Red Rubber	N9310050
11	Crimp	Amber Glass (Write on Patch)	Aluminum (Silver) Cap	PTFE/Red Rubber	N9310051
11	Crimp	Clear Glass (Write on Patch)	Aluminum (Silver) Cap	PTFE/Silicone ULB	N9310063

* ULB = Ultra Low Bleed

Standard Autosampler Vial, Cap and Septa Convenience Kits for LC

ID Size (mm)	Vial Neck Type	Vial Type	Cap Type	Septa Type	Part No. Pkg. 100
9	Screw	Clear Glass	Blue Cap	PTFE/Red Rubber	N9300699
9	Screw	Amber Glass	Blue Cap	PTFE/Silicone	N9300719
9	Screw	Clear Glass	Blue Cap	PTFE/Silicone	N9300700
9	Screw	Amber Polypropylene	Blue Cap	PTFE/Silicone (Pre-Slit)	N9301735
9	Screw	Clear Polypropylene	Blue Cap	PTFE/Silicone (Pre-Slit)	N9301736
9	Screw	Clear Glass	Blue Cap	PTFE/Silicone (Pre-Slit)	N9300701

Standard Autosampler Vial, Cap and Septa Convenience Kits for GC

ID Size (mm)	Vial Neck Type	Vial Type	Cap Type	Septa Type	Part No. Pkg. 100
11	Crimp	Clear Glass	Aluminum (Silver) Cap	PTFE/Red Rubber	N9300502
11	Crimp	Clear Glass	Aluminum (Silver) Cap	PTFE/Silicone	N9300500
11	Crimp	Clear Glass	Aluminum (Silver) Cap	PTFE/Silicone/PTFE	N9300501

Headspace Vials

We offer a variety of GC headspace vials, caps and septa to fulfil your application needs. Our patented vial and cap design incorporates pressure-relief features which guarantee safe operation with the high pressure typically developed during thermostating. Ordinary vials and caps without these safety features may burst. All of our headspace vials have a greater wall thickness and round base which enables them to withstand pressure up to 60 psig. Low-volume sampling can be achieved by using a 6 mL vial and vial adapter. All PerkinElmer headspace vials are manufactured to specific tolerances that are guaranteed for fit and performance.

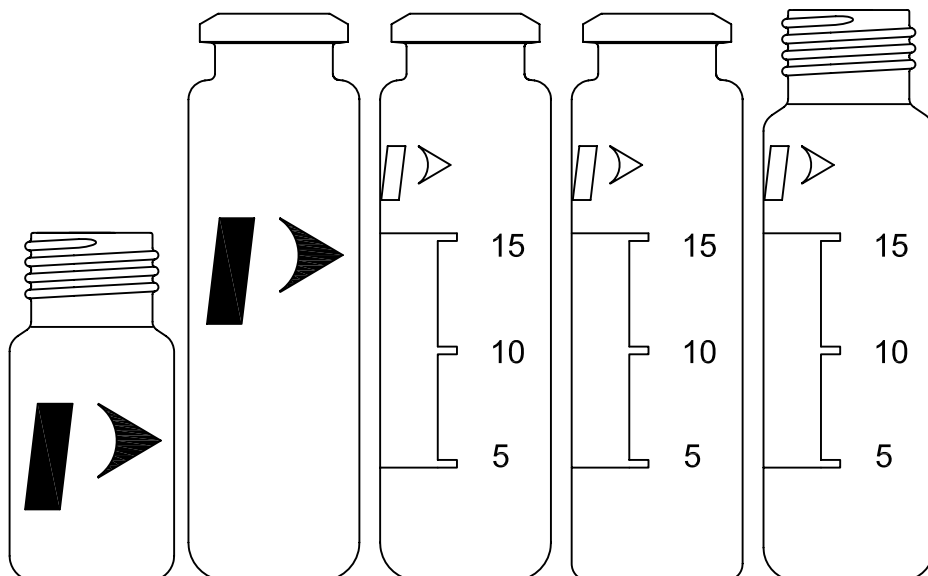

PureView 20 mL Headspace Vials

Our range of PureView Certified and MS Certified vials are manufactured from Type 1 borosilicate glass which meets all USP, JP, and EP requirements. PureView MS Certified vials have been thoroughly tested for residuals and approved on MS systems.

Select from a range of crimp or screw vials. All certification details are available at www.perkinelmer.com/COA where you simply enter the part number and lot number to retrieve the information.

	20 mL Clear Crimp Round Bottom	20 mL Clear Crimp Round Bottom Write on Patch	20 mL Clear Crimp Flat Bottom Write on Patch	20 mL Clear Screw Round Bottom Write on Patch	20 mL Clear Screw Flat Bottom Write on Patch
					
Neck Diameter	20 mm	20 mm	20 mm	18 mm	18 mm
Vial Dimensions	23 x 75.5 mm	23 x 75.5 mm	22.6 x 75.5 mm	23 x 75.5 mm	22.6 x 75.5 mm

PureView Certified 20 mL Headspace Vials



	Clear Crimp Round Bottom	Clear Crimp Round Bottom Write on Patch	Clear Crimp Flat Bottom Write on Patch	Clear Screw Round Bottom Write on Patch	Clear Screw Flat Bottom Write on Patch
Part Number Pkg. 100	N9305090	N9305091	N9305094*	N9305093	N9305092*

PureView MS Certified 20 mL Headspace Vials

	Clear Crimp Round Bottom	Clear Crimp Round Bottom Write on Patch	Clear Crimp Flat Bottom Write on Patch	Clear Screw Round Bottom Write on Patch	Clear Screw Flat Bottom Write on Patch
Part Number Pkg. 100	n/a	N9305081	N9305083*	N9305082	n/a
Part Number Pkg. 1,000	n/a	N9305080	n/a	N9305103	N9305084*

* These dimensions are suitable for non-PerkinElmer instrumentation.

See next page for PureView 20 mL Headspace Vial Instrument Compatibility.

	20 mL Clear Crimp Round Bottom	20 mL Clear Crimp Round Bottom Write on Patch	20 mL Clear Crimp Flat Bottom Write on Patch	20 mL Clear Screw Round Bottom Write on Patch	20 mL Clear Screw Flat Bottom Write on Patch
					
Neck Diameter	20 mm	20 mm	20 mm	18 mm	18 mm
Vial Dimensions	23 x 75.5 mm	23 x 75.5 mm	22.6 x 75.5 mm	23 x 75.5 mm	22.6 x 75.5 mm

PureView 20 mL Headspace Vial Instrument Compatibility

Manufacturer		20 mL Clear Crimp Round Bottom	20 mL Clear Crimp Round Bottom Write on Patch	20 mL Clear Crimp Flat Bottom Write on Patch	20 mL Clear Screw Round Bottom Write on Patch	20 mL Clear Screw Flat Bottom Write on Patch
PerkinElmer	Turbomatrix 16 / 40 / 110 / 150	✓	✓	-	✓	-
Thermo Scientific/Dionex	HS800 / HS850	-	-	✓	-	✓
	HS2000	-	-	✓	-	✓
	TriPlus	-	-	✓	-	✓
Agilent Technologies	7697A	-	-	✓	-	✓
	G1888A	✓	✓	-	✓	-
	HS 7694 / 7695A	-	-	✓	-	✓
CTC	PAL HTC-xt	-	-	✓	-	✓
	CTC Combi PAL	-	-	✓	-	✓
Shimadzu	HSS-2B/4B	-	-	✓	-	✓
	ASI-V	-	-	-	-	-
	HTA 200 H	-	-	✓	-	✓
	SIL-10HTA / SIL-10HTC	-	-	-	-	-
	AOC-5000	-	-	✓	-	✓
Tekmar	HT3	✓	✓	✓	✓	✓
	Tekmar SOLATek72 / AQUATek 70	-	-	-	-	-
	7000 / 7000HT / 7050	✓	✓	-	✓	-



Standard Headspace Crimp Top Vials

Round bottomed vials designed for use with PerkinElmer headspace instruments.

Vial Volume	Dimensions (OD x Height) (mm)	Description	Pkg.	Part No.
6 mL	21.75 x 38	Clear glass vial (requires Part No. N6120110 for use)*	125	N9302134
6 mL	–	Low volume adaptor for 6 mL vial (Part No. N9302134)*	10	N6120110
10 mL	21.75 x 46	Clear glass vial (requires Part No. N6120111 for use)	100	N6356478
10 mL	–	Low volume adaptor for 10 mL vial (Part No. N6356478)	10	N6120111
20 mL	23 x 75.5	Clear glass vial (no logo)	1000	N9306216
20 mL	23 x 75.5	Clear glass vial with 'P' logo	100	N9306079
20 mL	23 x 75.5	Clear glass vial, with 'P' logo	1000	B0104236
20 mL	23 x 75.5	Clear glass vial with write on patch and fill lines	100	N9303349
20 mL	23 x 75.5	Clear glass vial with write on patch and fill lines	1000	N9303348

* Not compatible with TurboMatrix HS 110 headspace sampler.

Standard Headspace Screw Top Vials

Round bottomed vials designed for use with PerkinElmer headspace instruments.

Vial Volume	Dimensions (OD x Height) (mm)	Description	Pkg.	Part No.
10 mL	23 x 46	Clear glass vial, no adaptor	100	N6356479
20 mL	23 x 75.5	Clear glass vial with 'P' logo	100	N9306075
20 mL	23 x 75.5	Clear glass vial with 'P' logo	1000	N9306078
20 mL	23 x 75.5	Clear glass vial with write on patch and fill lines	100	N9306240
20 mL	23 x 75.5	Clear glass vial with write on patch and fill lines	1000	N9306241

Standard CTC Headspace Vials

Vial Volume	Vial Closure Type	Dimensions (OD x Height) (mm)	Description	Pkg.	Part No.
20 mL	Crimp	22.6 x 75.5	Clear glass vial with 'P' logo (radius bottom)	100	N6356471
20 mL	Crimp	22.6 x 75.5	Clear glass vial with write on patch and fill lines (radius bottom)	100	N6356472
20 mL	Crimp	22.6 x 75.5	Clear glass vial with write on patch and fill lines (radius bottom)	1000	N9303351*
20 mL	Crimp	22.6 x 75.5	Clear glass vial with write on patch and fill lines (flat bottom)	1000	N9303352**
20 mL	Screw	22.6 x 75.5	Clear glass vial with write on patch and fill lines (radius bottom)	1000	N9306242

* Also suitable for Shimadzu, Tekmar and Varian.

** Also suitable for Agilent.

Headspace Vial, Cap and Septa Convenience Kits

We understand your challenges and offer a variety of kits so that you can easily order and restock your laboratory supplies.

PureView MS Certified 20 mL Headspace Convenience Kits

For your added convenience, and guaranteed fit, we have compiled some commonly used vial and cap combinations to help you quickly and easily restock your laboratory.



ID Size (mm)	Vial Neck Type	Vial Bottom Shape	Vial (Write on Patch and Fill Lines)	Cap Type	Septa type	Part No. Pkg. 100	Part No. Pkg. 1000
18	Screw	Round	Clear Glass	Magnetic Aluminum Cap	PTFE/Silicone ULB*	N9310059	N9310058
20	Crimp	Round	Clear Glass	Silver Aluminum Cap	PTFE/Silicone	N9310057	N9310056
20	Crimp	Round	Clear Glass	Silver Aluminum Cap with Star Spring Septa	PTFE/Silicone	N9310065	–
20	Crimp	Flat	Clear Glass	Silver Aluminum Cap	PTFE/Silicone	N9310061	N9310060
20	Crimp	Flat	Clear Glass	Silver Aluminum Cap with Star Spring Septa	PTFE/Silicone	N9310062	–

* ULB = Ultra Low Bleed

Standard Crimp Top 20 mL Headspace Convenience Kits

Septa Type	Cap Type	Vial Type	Part No. Pkg. 100	Part No. Pkg. 1000
PTFE/Silicone (white)	Aluminum Cap, Star Spring and Septa	20 mL Crimp Top Clear Glass with Write on Patch and Fill Lines (Radius Bottom)	N9303992	–
PTFE/Silicone (white)	Aluminum, Skived Pressure Relief (ultra bleed)	20 mL Crimp Top Clear Glass with Write-on Patch and Fill Lines (Flat Bottom)	–	N9300902
PTFE/Silicone (white)	Aluminum, Skived (non pressure release)	20 mL Crimp Top Clear Glass with Write-on Patch and Fill Lines (Flat Bottom)	–	N9300903

Standard Screw Top Headspace Convenience Kits

Septa Type	Cap Type	Vial Type	Part No. Pkg. 72
PTFE/Silicone	Open Top Gray Polypropylene Screw Cap	40 mL Screw Top Clear Glass (24 mm x 98 mm)	N6352030
PTFE/Silicone	Open Top Gray Polypropylene Screw Cap	40 mL Screw Top Amber Glass (24 mm x 98 mm)	N6352031
PTFE/Silicone	–	–	N6352032
–	Open Top Gray Polypropylene Screw Cap	–	N6352033*

* **N6352033** are only available in pkg. 24. **N6352032** is septa only. **N6352033** is cap only.

Headspace Starter Kits

We offer a variety of headspace consumables so you can evaluate different types of septa and vials for your sampling requirements.

Kits Include:	Part No.	Headspace Starter Kit 500	Headspace Starter Kit 100	Headspace Mini Starter Kit 1000
		Part No. B0505601	Part No. N6710195	Part No. N6710198
20 mm Hand Crimper	N9302785	1	1	1*
20 mL Clear Glass Crimp Top Vials	N9306079	500	500	1000
PTFE/Butyl (red) Septa with Pre-Assembled Aluminum Crimp Caps	B0104239	100	100	
PTFE/Silicone (white) Septa with Pre-Assembled Aluminum Crimp Caps	B0104241	100	100	1000
Aluminum/Silicone Septa with Pre-Assembled Aluminum Crimp Caps	B0104243	100	100	
20 mL Clear Glass Screw Top Vials	N9306075	500	100	
PTFE/Butyl (red) Septa with Steel Magnetic Screw Caps	N9306076	100	100	
PTFE/Silicone (white) Septa with Steel Magnetic Screw Caps	N9306077	100	100	
Needle Seal Assemblies	B0500833	2	2	
O-rings	B0198110	10	10	
Pressure Gauge with Needle for Vials	B0501377	1	1	
'Static Headspace GC Theory and Practice' book by B. Kolb and L.S. Ettre	N1011210	1	1	

* This kit includes an Ergonomic Hand Crimper.

Autosampler Caps and Septa

PerkinElmer offers a variety of caps and septa to fulfil your application needs. Our screw thread vial caps use the revolutionary Inter-Seal®. This uses a process that bonds silicone/PTFE and other elastomeric compounds directly into thermoplastic closures eliminates liner fallout, while still providing the excellent re-sealability and multiple injection capability. No adhesives are used in this process, bonding the cap and septa at the molecular level of plastic and rubber. These septa have a very broad chemical resistance and can be used in many markets including: environmental, diagnostic packaging, pharmaceutical packaging, cosmetic and food packaging.



Pre-Assembled Caps and Septa for LC

Crimp vials are commonly used for GC and screw vials commonly used for LC, but either crimp or screw configurations can be used.

Neck ID Size (mm)	Septa Type	Cap Type	Closure Type	Pkg.	Part No.
9	PTFE/silicone ultra-low bleed	Blue (polypropylene)	Screw	100	N9306362
9	PTFE/silicone ultra-low bleed (pre-slit)	Blue (polypropylene)	Screw	100	N9306364
9	PTFE/silicone ultra-low bleed (pre-slit)	Blue (polypropylene)	Screw	1000	N9306365
9	PTFE/silicone	Blue (polypropylene)	Screw	100	N9306202
9	PTFE/silicone (pre-slit)	Blue (polypropylene)	Screw	100	N9306203
11	PTFE/red rubber	Aluminium (silver)	Crimp	100	N9306015
11	PTFE/red rubber	Aluminium (blue)	Crimp	100	N9302686
11	PTFE/silicone (red/white)	Aluminium (silver)	Crimp	100	N9306228
11	PTFE/Silicone (red/white) ultra-low bleed	Aluminium (silver)	Crimp	100	N9304148
11	PTFE/silicone/PTFE	Aluminium (silver)	Crimp	100	N9306229

Pre-Assembled Caps and Septa for GC

Crimp vials are commonly used for GC and screw vials commonly used for LC, but either crimp or screw configurations can be used.

Neck ID Size (mm)	Septa Type	Cap Type	Closure Type	Pkg.	Part No.
9	PTFE/silicone ultra-low bleed	Blue (polypropylene)	Screw	100	N9306362
9	PTFE/silicone	Blue (polypropylene)	Screw	100	N9306202
11	PTFE/red rubber	Aluminium (silver)	Crimp	100	N9306015
11	PTFE/red rubber	Aluminium (green)	Crimp	100	N9302684
11	PTFE/red rubber	Aluminium (red)	Crimp	100	N9302685
11	PTFE/red rubber	Aluminium (blue)	Crimp	100	N9302686
11	PTFE/silicone (red/white)	Aluminium (silver)	Crimp	100	N9306228
11	PTFE/silicone, ultra-low bleed (red/white)	Aluminium (silver)	Crimp	100	N9304148
11	PTFE/silicone/PTFE	Aluminium (silver)	Crimp	100	N9306229

Ultra Low Bleed Septa





Septa quality, as well as vial quality, are important to ensure rugged and reproducible analytical results, day in day out. Our range of ultra-low bleed septa offers the ultimate in purity and inertness. Eliminate potential contamination from septa which can lead to interferences, inaccuracies and failures which ultimately effects lab productivity. A range of septa combinations are available for standard analytical and headspace applications. The 1.3 mm thick septa are recommended for SPME applications.

2 mL Caps with Ultra Low Bleed Septa

Neck ID Size (mm)	Description	Material	Screw Top		Crimp Top
			Part No.	Pkg. 100	Part No.
9	PTFE/Silicone	Blue polypropylene	N9306362		
9	PTFE/Silicone (pre slit)	Blue polypropylene	N9306364		N9306365
11	PTFE/Silicone (red/white)	Aluminium (silver)			N9304148

Headspace Caps with Ultra Low Bleed Septa

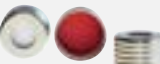
As the ultra low bleed septa in the headspace crimp caps are thinner than the standard septa, it is essential to use a higher necked vial to ensure a tight crimp. Part number **N9306883** should be used. Applying the caps to an alternative vial does not guarantee a tight seal.

Septa Type	Cap Type	Crimp Top		Screw Top
		Part No.	Pkg. 100	Part No.
 PTFE/Silicone (blue/white) 1.5 mm thick – must be used with high neck crimp vials (N9306883) to ensure a tight seal	Bi-Metal Cap	N9304181		
 PTFE/Silicone (blue/white) 1.5 mm thick	Aluminium Magnetic Cap			N9304175
 PTFE/Silicone (red/white) 1.3 mm thick	Aluminium Magnetic Cap			N9304177
 PTFE/Silicone (white/blue) 1.3 mm thick	Aluminium Magnetic Cap			N9304179

Headspace Caps and Septa

Choose the right septa for your analysis. Although a wide variety of septa is available, chemical compatibility and temperature are the most critical to the analysis. Temperature applies not only to the vial, but also to the temperature of the instrument's needle used for pressurization and sample transfer, which is heated to prevent condensation. A needle temperature higher than the vial temperature setting can decompose the septum material. PTFE coated silicone offers the highest temperature operating limits.

(See Septa Recommended Chart on page 19 for more details.)



Pre-Assembled Aluminum Crimp Caps and Septa

Septa Type	Aluminum Caps (Pre-Assembled)	Crimp Top Part No. Pkg. 100	Crimp Top Part No. Pkg. 1000
PTFE/Silicone (white)	Aluminum Cap, Star Spring and Septa	N9304146	B4000022
PTFE/Silicone (white)	Aluminum, Skived Pressure Relief		N9302975
PTFE/Silicone (blue/white) 1.5 mm thick – must be used with high neck crimp vials (N9306883) to ensure a tight seal	Bi-Metal Cap	N9304181	
Ultra Low Bleed PTFE/Silicone (blue/white) 1.5 mm thick – must be used with high neck crimp vials (N9306883) to ensure a tight seal	Silver Aluminium Cap		N9304184

Un-Assembled Aluminum Crimp Caps and Septa

Septa Type	Aluminum Caps (Un-Assembled)	Crimp Top Part No. Pkg. 100	Crimp Top Part No. Pkg. 1000
PTFE/Silicone (white)	Aluminum Cap, Star Spring and Septa	B0104241	B0104242
Aluminum/Silicone	Aluminum Cap, Star Spring and Septa	B0104243	B0104244

Pre-Assembled Magnetic Crimp and Screw Caps and Septa



Septa Type	Closure	Magnetic Caps (Pre-Assembled)	Part No. Pkg. 100
PTFE/Silicone (red)	Screw	Steel Magnetic Cap	N6356474
PTFE/Silicone (blue/white) 0.060 in. thick	Screw	Steel Magnetic Cap	N6356476
PTFE/Silicone (white)	Screw	Steel Magnetic Cap	N9306077
PTFE/Silicone (blue)	Crimp	Steel Magnetic Cap	N6356559
PTFE/Silicone (blue)	Screw	Steel Magnetic Cap	N6356475
PTFE/Silicone (blue)	Crimp	Bi-Metal Magnetic Cap	N6356566
Ultra Low Bleed PTFE/Silicone (blue/white) 1.5 mm thick	Crimp	Bi-Metal Cap	N9304181
Ultra Low Bleed PTFE/Silicone (blue/white) 1.5 mm thick	Screw	Aluminium Magnetic Cap	N9304175
Ultra Low Bleed PTFE/Silicone (red/white) 1.3 mm thick	Screw	Aluminium Magnetic Cap	N9304177
Ultra Low Bleed PTFE/Silicone (white/blue) 1.3 mm thick	Screw	Aluminium Magnetic Cap	N9304179

Crimpers: Electronic, Handheld and Benchtop

Crimping Tools and Vial Accessories

Whatever your need may be, we offer a wide range of crimping tools for your convenience. Our universal voltage, precision control, power crimpers with adjustable settings are designed to deliver hundreds of crimps on a single battery charge. The tools are ergonomically designed to reduce strain associated with the repetitive actions of using a blocky metal manual crimping tool.



Manual Ergonomic Crimper



Electronic Hand Crimper



Benchtop Crimper

Autosampler Crimper and Decapper Tools

Description	Qty.	Part No.
Benchtop Crimper	1	N6621006
Benchtop Crimper Jaws – 11 mm	1	N6621008
Electronic Hand Crimper – 11 mm	1	N9304500
Electronic Hand Decapper – 11 mm	1	N9304502
6.4V Lithium Ion Battery For Electronic Crimper/Decapper	1	N9304504
Manual Hand Crimper – 8 mm	1	N9306127
Manual Hand Crimper – 11 mm	1	00090699
Manual Hand Crimper (Ergonomic) – 11 mm	1	N6621035
Manual Hand Decapper – 11 mm	1	N9301390
Manual Hand Decapper (Ergonomic) – 11 mm	1	N6621036

Headspace Crimper and Decapper Tools

Description	Qty.	Part No.
Benchtop Crimper	1	N6621006
Benchtop Crimper Jaws – 20 mm	1	N6621009
Electronic Hand Crimper – 20 mm	1	N9304501
Electronic Hand Decapper – 20 mm	1	N9304503
6.4V Lithium Ion Battery For Electronic Crimper/Decapper	1	N9304504
Manual Hand Crimper – 20 mm	1	N9302785
Manual Hand Crimper (Ergonomic) – 20 mm	1	N6621037
Manual Hand Decapper – 20 mm	1	N9301270
Manual Hand Decapper (Ergonomic) – 20 mm	1	N6621038



Vial Racks

Description	Qty.	Part No.
11 mm Vial Rack – 50 Vial Capacity	1	N9301303
20 mm Vial Rack – 36 Vial Capacity	1	N9301304

High Powered Crimpers and Decappers

The high powered crimper and decapper is an essential laboratory accessory for any high through put environment. Experience the benefits of not only fast and accurate crimping or decapping, but also the ultimate tool in flexibility with interchangeable jaw sets. Now in a single unit, you can crimp and decap standard analytical vials and headspace vials. Changing the jaws, either size or function, takes a matter of just seconds.



High Powered Crimper with Jaw Set

Description	Qty.	Part No.
High Powered Crimping Tool	1	N9304510
20 mm Crimper Jaw Set	1	N9304511
20 mm Decapper Jaw Set	1	N9304512
11 mm Crimper Jaw Set	1	N9304513
11 mm Decapper Jaw Set	1	N9304514
Base and Mounting Kit	1	N9304515

SPP HPLC and UHPLC Columns

Superficially Porous Particle (SPP) columns produce sharper peaks and faster separation results. These results are possible due to their breakthrough particle design and size. SPP columns use particles comprising a thin outer shell of porous silica fused to a solid inner core. This advanced design allows for a shorter diffusion path, reducing the time solute molecules spend inside the particles while passing through the stationary phase.

Material Characteristics

Brand	Phase	Particle Size (µm)	Pore Size (Å)	Carbon %	End Cap	pH Range	USP Code
Quasar SPP	PAH	2.6	80	9.9	No	2-9	–
Brownlee SPP	C18	2.7	90	8	Yes	2-9	L1

SPP C18 Columns

Brownlee SPP C18 offers a general purpose Octadecyl phase for reverse phase separations.

Phase	Length (mm)	ID (mm)	Particle Size (µm)	Part No.
SPP C18	30	4.6	2.7	N9308413
SPP C18	50	2.1	2.7	N9308402
SPP C18	50	3.0	2.7	N9308408
SPP C18	75	2.1	2.7	N9308403
SPP C18	100	2.1	2.7	N9308404
SPP C18	150	2.1	2.7	N9308405
SPP C18	150	3.0	2.7	N9308411
SPP C18 Analytical Guard Cartridges (pkg. 3)	5	2.1	2.7	N9308513
SPP C18 Analytical Guard Cartridges (pkg. 3)	5	3.0	2.7	N9308514
SPP C18 Analytical Guard Cartridges (pkg. 3)	5	4.6	2.7	N9308515
SPP Analytical Guard Cartridge Holder	–	–	–	N9308534

Other column dimensions are available.

HPLC analysis of 8 parabens using Brownlee SPP C18 100 x 3.0 mm, 2.7 µm.

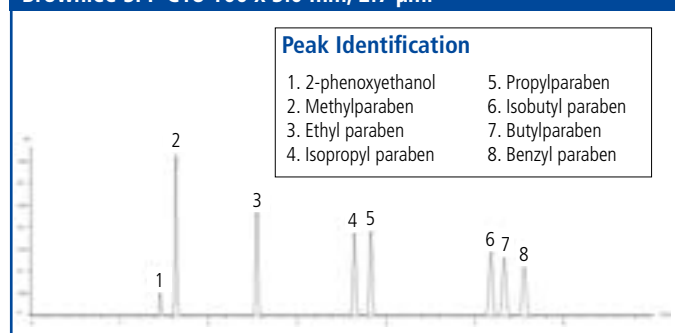

SPP PAH Columns

Quasar SPP PAH phase offers a highly selective separation of polynuclear aromatic hydrocarbon (PAH) compounds in a variety of matrices, with excellent peak shape and baseline resolution. Ideal for US EPA Methods (e.g. EPA 610, 8310, 550.1).

Phase	Length (mm)	ID (mm)	Particle Size (µm)	Part No.
SPP PAH	100	2.1	2.6	N9307261
SPP PAH	100	3.0	2.6	N9307264
SPP PAH	150	2.1	2.6	N9307262
SPP PAH	150	3.0	2.6	N9307265
SPP PAH Analytical Guard Cartridges (pkg. 3)	50	2.1	2.6	N9307269
SPP PAH Analytical Guard Cartridge Holder	–	–	–	N9307270

Other column dimensions are available.

HPLC analysis of EPA Method 8310 quality control check solution using Quasar SPP PAH, 100 x 3.0 mm, 2.6 µm.

Peak Identification

- | | |
|------------------------|----------------------------|
| 1. Naphthalene | 10. Pyrene |
| 2. Acenaphthylene | 11. Benzo(a)anthracene |
| 3. 1-methylnaphthalene | 12. Chrysene |
| 4. 2-methylnaphthalene | 13. Benzo(b)fluoranthene |
| 5. Acenaphthene | 14. Benzo(k)fluoranthene |
| 6. Fluorene | 15. Benzo(a)pyrene |
| 7. Phenanthrene | 16. Dibenzo(a,h)anthracene |
| 8. Anthracene | 17. Benzo(g,h,i)perylene |
| 9. Fluoranthene | 18. Indeno(1,2,3-cd)pyrene |

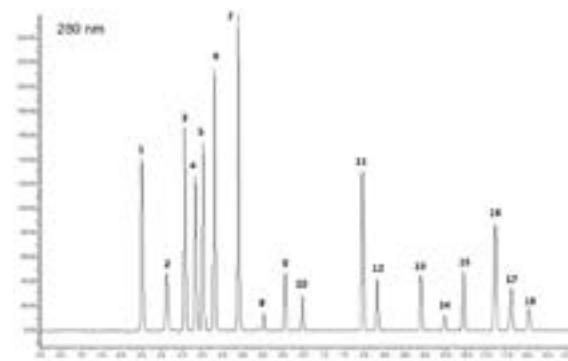

LC Accessories & Consumables

PerkinElmer offers a wide selection of superior quality products designed to work with your PerkinElmer instruments. Our precision designed products deliver the peace of mind that comes from knowing that you'll get the results you need.

Quick Reference Index

	Page
▶ Instrument Spares and Consumables	39-55
▶ LX 50 Spares	49
▶ QSight	50-53
▶ Flexar	42-48
▶ Series 200	54-55
▶ LC 300 Spares	39-41
▶ General LC Accessories	169-173
▶ Fittings, Nuts and Ferrules	172
▶ Microsyringes (For Manual Injection)	169
▶ Rheodyne Valves	169
▶ Rheodyne Spare Parts, Sample Loops, Internal Loops, and Rotor Seals	169-170
▶ Solvent Sparger and Solvent Filters	171
▶ Starter Kits	174
▶ Tubing	171
▶ Vacuum Degassing Kits	173

LC 300 Instrument Spares

For your convenience a list of commonly used parts to keep your system running at optimal performance.



▶ [VIEW PAGE](#)

LX-50 Instrument Spares

An overview of key spares and consumables needed to keep your LX-50 LC system operating at optimum productivity.



▶ [VIEW PAGE](#)

Rheodyne Valves and Spare Parts

A range of valves with associated spares for LC/MS (low dispersion), biological applications (PEEK valves) and high precision, high accuracy standard LC applications.



▶ [VIEW PAGE](#)

LC Starter Kits

Essential items to keep your pumps running at maximum efficiency; seals, pistons and check valves.



▶ [VIEW PAGE](#)

LC 300 Instrument Spares



Lamps



Deuterium Lamp



Tungsten Lamp

UV/VIS Detector Lamps

Description	Part No.
Deuterium Lamp	N2920149
Tungsten Lamp	N2920146

MWD and PDA Detector Lamp

The LC 300 lamps provide true UV/VIS detection. The excellent signal-to-noise characteristics make it ideally suited for low volume or low concentration samples. Additionally, the LC 300 PDA detector provides high-resolution spectral data.

Description	Part No.
Deuterium Lamp	09290900

Fluorescence Detector Lamps

The major benefit afforded by fluorescence detection is the inherent high sensitivity of the technique coupled with outstanding specificity. The LC 300 Fluorescence detector provides excellent signal-to-noise ratio for trace analysis using a 150 W xenon source.

Description	Part No.
Xenon Lamp	N2555048

Refractive Index Detector Light Source

The LC 300 Refractive Index detector, with its deflection type design, allows sensitive detection of non-UV absorbing compounds with low noise and drift characteristics. The lamp is a long-lasting LED light source.

Description	Part No.
Light Source Assembly (including cable and connector)	N2556009

Our extensive quality control and inspection process demand the very best quality sources. Choosing a PerkinElmer deuterium, tungsten, or xenon source provides outstanding ultraviolet and true visible performance.

- Exceptional performance anywhere in the detector wavelength ranges (UV/Vis: 190-700 nm, photodiode array detector (PDA) and multi-wavelength UV/Vis detector (MWD): 190-790 nm, Fluorescence: 200-900 nm).
- Lamp changes are quick and easy due to a unique self-aligning clamp mount for the for the UV/Vis, MWD, and PDA detectors.

Flowcells

Detector FlowCells

The LC 300 flowcells provide the highest detection limits possible for your sample. The 6 mm pathlength flowcell for the UV/Vis detector has been optimized for lower-dispersion LC analysis and is the perfect choice when using narrow bore, 2.1 mm or microbore, 1 mm columns.

Description	Size	Part No.
Flowcell	6 mm x 2.4 µL	N2920127
Flowcell	Dry Cell	29000078

Multiwavelength (MWD) and Photodiode Array (PDA) Detectors Flowcells

Description	Size	Part No.
Flowcell (Standard)	10 mm x 1 µL	N2950450
Flowcell	50 mm x 5 µL	N2950455
Flowcell	Dry Cell	N2950429

Fluorescence Detector Flowcells

Description	Size	Part No.
Flowcell Complete	12 µL	N2555049
Flowcell Complete	4 µL	N2555054

Detector Backpressure Regulator

The detector backpressure regulator is a device that is attached to the outlet of the detector to prevent outgassing in the flowcell, eliminating variations to the detector baseline.

Description	Volume	Part No.
Backpressure Regulator	40 psi in-line	N2925090
Backpressure Regulator Adjustable - Stainless Steel	15-59 psi	09907126

High Pressure Analytical Mixers

Mixers are important in facilitating complete mobile phase blending, resulting in improved retention performance. These mixers should be used as part of LC 300 systems, where high pressure blending is required. Mixers incorporate a highly efficient cross-flow shearing mechanism that produces vortex shear mixing over a wide range of volumes. They are now offered in 18,000 psi pressure max flavor. The Combo mixer used in the LC 300 pump is a mixer and in-line filter combined. A 35 µL mixer ships with the 18K (UHPLC) binary pump and a 100 µL mixer ships with the 10K (HPLC) binary pump.

Description	Volume	Part No.
Combo. Mixer Assembly with 2 µm Inline Filter	35 µL	N2991143
Combo. Mixer Assembly with 2 µm Inline Filter	100 µL	PLEASE ENQUIRE
Plastic Priming Syringe	30 mL	09904849
Replacement 2 µm Filter for Mixer (1 ea.)	1 Each	N2991113

Pump Accessories

All pump accessories listed are applicable for the 10K (HPLC) and the 18K (UHPLC) binary and quaternary pumps.

Pump Preventive Maintenance (PM) and Lubrication Kits

Description	Part No.
(U)HPLC Gradient Pump Basic PM Kit (6 Months)	N2991115
(U)HPLC Gradient Pump Premium PM Kit (12 Months)	N2991114
(U)HPLC Gradient Pump Lubrication Kit	N2991136

Pump Seals, Pistons and Check Valves

Description	Part No.
Check Valve Cartridge (Single)	N2991112
Check Valve Housing, Inlet Assembly	N2991120
Check Valve Housing, Outlet Assembly	N2991121
High-Pressure Seal	N2991111
Outlet Filter, 2 µm	N2991113
Seal Replacement Tool	N2991100
Piston Cartridge Replacement Kit (Piston and Seal for the Seal Wash)	N2991107
10-µm Solvent Line Filters (Sinkers)	09903610

Pump Replacement Tubing

Description	Part No.
Tubing, Stainless Steel, 1/16 in., Pump to Pump	N2991101
Tubing, Stainless Steel, 1/16-in., Pump A to Valve	N2991105
Tubing, Stainless Steel, 1/16 in., Pump B to Valve	N2991106
Tubing, Stainless Steel, 1/16 in., Valve to Purge Pump A	N2991102
Tubing, Stainless Steel, 1/16 in., Valve to Purge Pump B	N2991104
Tubing, Stainless Steel, 1/16 in., Valve to Mixer	N2991103

Pump Backpressure Regulator

Description	Part No.
Pump Backpressure Regulator (Adjustable up to 5,000 psi)	N2925091
1000 psi Pressure Assembly	N2910381



Combo Mixer

Autosampler General Accessories



250 µL Syringe Kit with 500 µL Buffer Tubing **N2936052**

Loops

Stainless Steel Sample Loops



Stainless Steel loops required for use with LC 300 systems (up to 18,000 psi)

Description	Size	Part No.
Sample Loop, Stainless Steel	2 µL	N2936071
Sample Loop, Stainless Steel	5 µL	N2936056
Sample Loop, Stainless Steel	10 µL	N2936057
Sample Loop, Stainless Steel	20 µL	N2936058
Sample Loop, Stainless Steel	50 µL	N2936059
Sample Loop, Stainless Steel	100 µL	N2936060
Sample Loop, Stainless Steel	200 µL	N2936061
Sample Loop, Stainless Steel	500 µL	N2936062
Sample Loop, Stainless Steel	1 mL	N2936063
Sample Loop, Stainless Steel	2 mL	N2936064
Sample Loop, Stainless Steel	5 mL	N2936065

Valve Parts

Valve Maintenance Parts

Description	Part No.
Valve Rotor Seal for UHPLC Injection Valve	N2552009
Valve Rotor Seal for the HPLC Injection Valve	N2552010
Stator for 18K	N2932002

Trays

Trays and Accessories

Description	Part No.
25-Position 6 mL Vial Sample Tray	N2936045
80-Position 2 mL Vial plus (5) 6 mL Vial Tray (for Derivatization)	N2936046
80-Position 2 mL Vial Tray with Dilution Tray	N2930676
96-Well Microtiter Adapter	N9302562
96-Well 'Deep-well' Microtiter Adapter	N9302560
96-Well 7 mm Pre-slit Silicone Plate Mat/Seal	N9302555
96-Well 'Deep' Microtiter Plate Adaptor (Supports Dual Microtiter Plates)	N2936048
96-Well 'Shallow' Microtiter Plate Adaptor (Supports Dual Microtiter Plates)	N2936049
384-Well Microtiter Adapter	N2936050
100-Position 2 mL Vial Sample Tray	N2936042
(200) 0.2 mL Microvial plus (5) 2 mL Vial Tray	N2936043

Syringes

Sampling Syringes

Description	Size	Part No.
Sampling Syringe	50 µL	09923304
Sampling Syringe	100 µL	09923305
Sampling Syringe	250 µL	09923270
Sampling Syringe	500 µL	09923306
Sampling Syringe	1000 µL	09923307
Syringe Tip Replacements (pkg. 10)	250 µL	N2936003

Needles and Syringes Kits

Description	Part No.
Syringe Kit, 100 µL w/ 200 µL Buffer Tubing	N2936051
Syringe Kit, 250 µL w/ 500 µL Buffer Tubing	N2936052
Syringe Kit, 500 µL w/ 1000 µL Buffer Tubing	N2936053
Syringe Kit, 1000 µL w/ 2000 µL Buffer Tubing	N2936054
Syringe Kit, 2500 µL w/ 5000 µL Buffer Tubing	N2936055
Sample Needle with Fittings	N2936009
Air Guide Needle, 62 mm	N2936000
Air Guide Needle, 80 mm	N2936342
Bio Compatible Sample Needle w/ Connectors	N2936010
Blunt Tip Needle	N2931199
Service Aid Tool Spacer	N2936346

Flexar Instrument Spares



Flexar UV/Vis PDA Flowcells

These flowcells provide the highest detection limits possible for your sample. The 6 mm pathlength flowcell has been optimized for lower-dispersion LC analysis and is the perfect choice when using narrowbore, 2.1 mm or microbore, 1 mm columns. The 3 mm pathlength is the choice for semiprep LC to avoid detector saturation at high-solute concentrations.

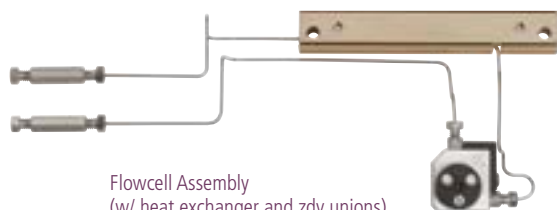

Flowcell Assembly
(w/ heat exchanger and zdv unions)

UV/Vis and PDA Flowcells and Assemblies

Description	Size	Part No.
Flowcells for Flexar FX-UV/Vis UHPLC Detectors		
Flowcell	6 mm x 2.4 µL	N2920127
Flowcell Kit (includes flowcell and detector head plate w/ gasket)	6 mm x 2.4 µL	N2920070
Flowcell Kit (includes flowcell w/ heat exchanger and zdv unions)	10 mm x 15 µL	N2920125
Flowcell	10 mm x 15 µL	N2920124
Flowcell Assembly	6 mm x 2.4 µL	N2920128
Prep Flowcell Assembly (w/ zdv unions)	3 mm x 1.7 µL	29000545
Flowcells for Flexar FX-PDA UHPLC PDA Detectors		
Flowcell Assembly (dual-lensed)	6 mm x 2.4 µL	N2920166
Flowcells for Flexar PDA Detectors		
Flowcell	10 mm x 15 µL	N2920126
Flowcell Assembly	10 mm x 15 µL	N2920160
Flexar PDA Plus		
Flowcell	10 mm x 1 µL	N2950450
Flowcell	50 mm x 5 µL	N2950455
Flowcell	Dry Cell	N2950429

Flexar Needles, Syringes and Kits

PerkinElmer syringe kits for high pressure applications are manufactured for precise liquid delivery. All of these glass syringes come with precision stainless steel plungers. They are used for sampling and flushing and are available in a large variety of sizes.

Flexar Autosampler Needles

Sample needle/w fittings has a 90° bevel and is the standard needle for the Flexar system. The Bio compatible needle features an inert titanium needle.

Air guide needles are available in two different lengths to accommodate different plate heights in the autosampler. The standard air needle is a 62 mm needle. This air needle accommodates use of a wide range of high and low plates.

Blunt tip/low volume needles are for injection of low µL volumes out of already low µL samples. The needle inlet is at the very tip, instead of slightly up the side, to ensure reliable sampling.

Description	Part No.
Sample Needle w/ Fittings	N2936009
Air Guide Needle (62 mm)	N2936000
Bio Compatible Sample Needle w/ Tubing Connector	N2936010
Air Guide Needle (80 mm)	N2936342
Blunt Tip/Low Volume Needle	N2931199

Flexar Autosampler Syringe Kits

Dimension	Buffer Tubing	Part No.
100 µL	200 µL	N2936051
250 µL	500 µL	N2936052
500 µL	1,000 µL	N2936053
1,000 µL	2,000 µL	N2936054
2,500 µL	2,000 µL	N2936055

Flexar Autosampler Syringes

Syringe replacements for current system setup. If syringe size is changed from current setup, a syringe kit (containing the relevant sized tubing) is required.

Contents	Size	Part No.
Sampling Syringe	50 µL	09923304
Sampling Syringe	100 µL	09923305
Sampling Syringe	250 µL	09923270
Sampling Syringe	500 µL	09923306
Sampling Syringe	1000 µL	09923307
Sampling Syringe	2500 µL	09923219*
Sampling Syringe Kit 2500 µL (includes 2500 µL syringe, union and tubing kit)	2500 µL	N2930313
Flush Syringe	2500 µL	09923219

*Requires one-time purchase of **N2930313**.

Flow Cells and Pump Accessory Kits

Pump Seal Kits

Description	Part No.
Micropump Piston Seal Replacement Kit Includes: Seals and O-rings	N2910384
Flexar Standard LC Pump Maintenance Kit Includes: Fuses, Seals, O-rings and Seal Tools	N2910345



Detector Backpressure Regulator

Detector Backpressure Regulator

The detector backpressure regulator is a device that is attached to the outlet of the detector to prevent outgassing in the flowcell, eliminating variations to the detector baseline.

Description	Material	Part No.
40 psi in-line backpressure regulator		N2925090
2 – 5K psi variable backpressure regulator		N2925091
Backpressure Regulator Adjustable from 15 – 59 psi	Stainless Steel	09907126

Flexar HPLC and UHPLC Detector Lamps



UV/VIS Deuterium Detector Lamp

Our extensive quality control and inspection process demands the very best quality sources. Choosing a PerkinElmer deuterium, tungsten or xenon source provides outstanding ultraviolet and true visible performance.

- Exceptional performance anywhere in the detector's 190 – 700 nm wavelength range
- Lamp changes are quick and easy due to a unique self-aligning lamp mount

UV/VIS Detector Lamps

Description	Part No.
Flexar UV/VIS Detector Lamps	
Deuterium Lamp	N2920149
Tungsten Lamp	N2920146

Refractive Index Detector Lamps

The Flexar Refractive Index lamps, with its deflection-type design, allows sensitive detection of these compounds with low noise and drift characteristics.

Description	Part No.
Flexar	
Refraction Index (RI) Lamp	02712303



Photo Diode Array Detector Lamp

Photo Diode Array Detector Lamps

The Flexar Photo Diode Array Detector provides true UV/VIS detection and high resolution spectral data. The excellent signal-to-noise characteristics make it ideally suited for low-volume or low concentration samples.

Components	Part No.
Flexar	
Deuterium Lamp (PDA)	N2925030
Deuterium Lamp (PDA Plus)	09290900
Tungsten Lamp	N2922011

Fluorescence Detector Lamps

The major benefit afforded by fluorescence detection is the inherent high sensitivity of the technique coupled with outstanding specificity. The Fluorescence Detector provides signal to noise ratio of >700:1 from trace analysis using a 150 W xenon source.

Components	Part No.
Flexar	
Xenon Lamp	N2922082
Festoon Lamp	04969486

Flexar FX-15 and FX-20 Pump Head

Check Valve Assemblies

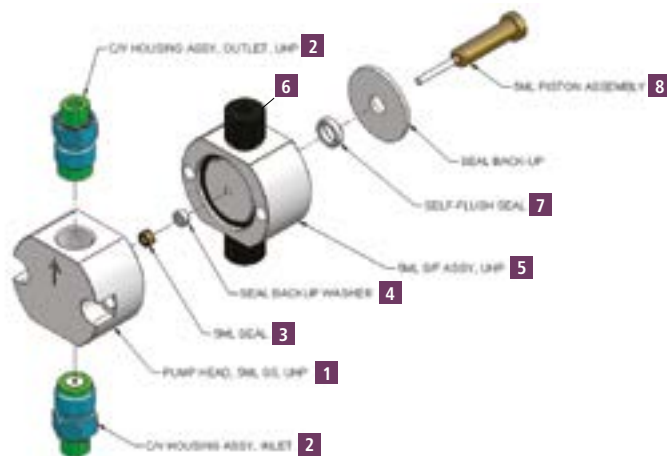
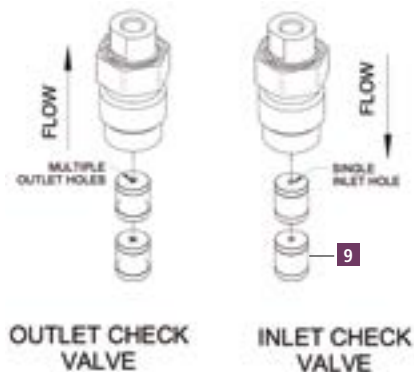

Description	FX-15	FX-20	
	Stainless Steel Part No.	Standard Stainless Steel Part No.	Biocompatible Titanium Part No.
1 Pump Head (Stainless Steel – pkg. 2, Titanium – each)	†	N2911251	N2911244
2 Inlet/Outlet Check Valve Kit (1 inlet and 1 outlet)	N2911220	N2911220	–
3 High Pressure Piston Seal	*	*	*
4 High Pressure Piston Seal Backup Washer	*	*	*
5 Self Flush Assembly w/ Seals	N2911235	N2911235	N2911245
6 Self-Flush Check Valve Kit (1 inlet and 1 outlet)	N2911236	N2911236	N2911236
7 Self-Flush Seal	*	*	*
8 Piston	N9308535	N9308535	N9308535
9 Check Valve Capsule (Stainless Steel – Each, Titanium – pkg. 4)	N2911239	N2911239	N2911240
10 0.5 mm Tee Assembly Frit	N2911224	N2911224	N2911241
11 Check Valve Capsule	N2911239	N2911239	N2911240

* Seals sold in Kits only. See Preventive Maintenance and Seal Kits.

† Replacement with FX-20 pump heads (N2911251) is recommended.

Preventive Maintenance (PM) and Seal Kits

Description	Part No.
FX-15 PM Kit Complete (4 Heads)	N2911249
FX-15 Single Head Seal Kit (1 Head)	N2911221
FX-15 Heavy Duty HP Seals (1 Head)	N9308536
FX-20 PM Seal Kit (4 Heads)	N2911250

Tee Valve Assembly

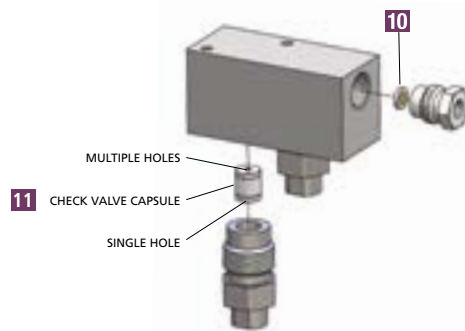

Flexar Seals, Pistons and Check Valves

Check valves, which include a sealing washer, are easy to install using the optional Torque Wrench kit. For all PerkinElmer pumps an intermediate check valve is required. The input check valve, which is identical, should be ordered.

Description	Flexar LC			FX-10
	Standard Stainless Steel Part No.	Micropump Stainless Steel Part No.	Biocompatible Titanium Part No.	Micropump Stainless Steel Part No.
1 Standard High Pressure Piston Seal	09907324	09923367 [†]	09907338	09923367 [†]
1 High Pressure Piston Seal – Chemically Resistant	09907345			
2 High Pressure Piston with Seal Backup Ring	02542076	†		†
3 High Pressure Piston Seal PTFE O-ring	09902128	09902128	09902018	09902128
4 Low Pressure Piston Seal		09923366	09907339	09923366
5 Low Pressure Piston Seal Backup Guide Bushing	02542313	N2915006		N2915006
6 High Pressure Piston	N2600124	N2910511	N2600124	N2910511
7 Low Pressure Piston	N2600117	N2910512	N2600104	N2910512
8 Inlet Check Valve	02540177	02540177	N2600226	02540177
9 Intermediate Check Valve	02540177	02540177	N2600226	N2916052
10 Outlet check Valve	02540197	02540197	N2600192	02540154

* Refer to Users Manual for complete illustrated parts list.

† High Pressure Piston Seal Backup ring (2) is included with the Standard High Pressure Piston Seal (1).



Check Valves

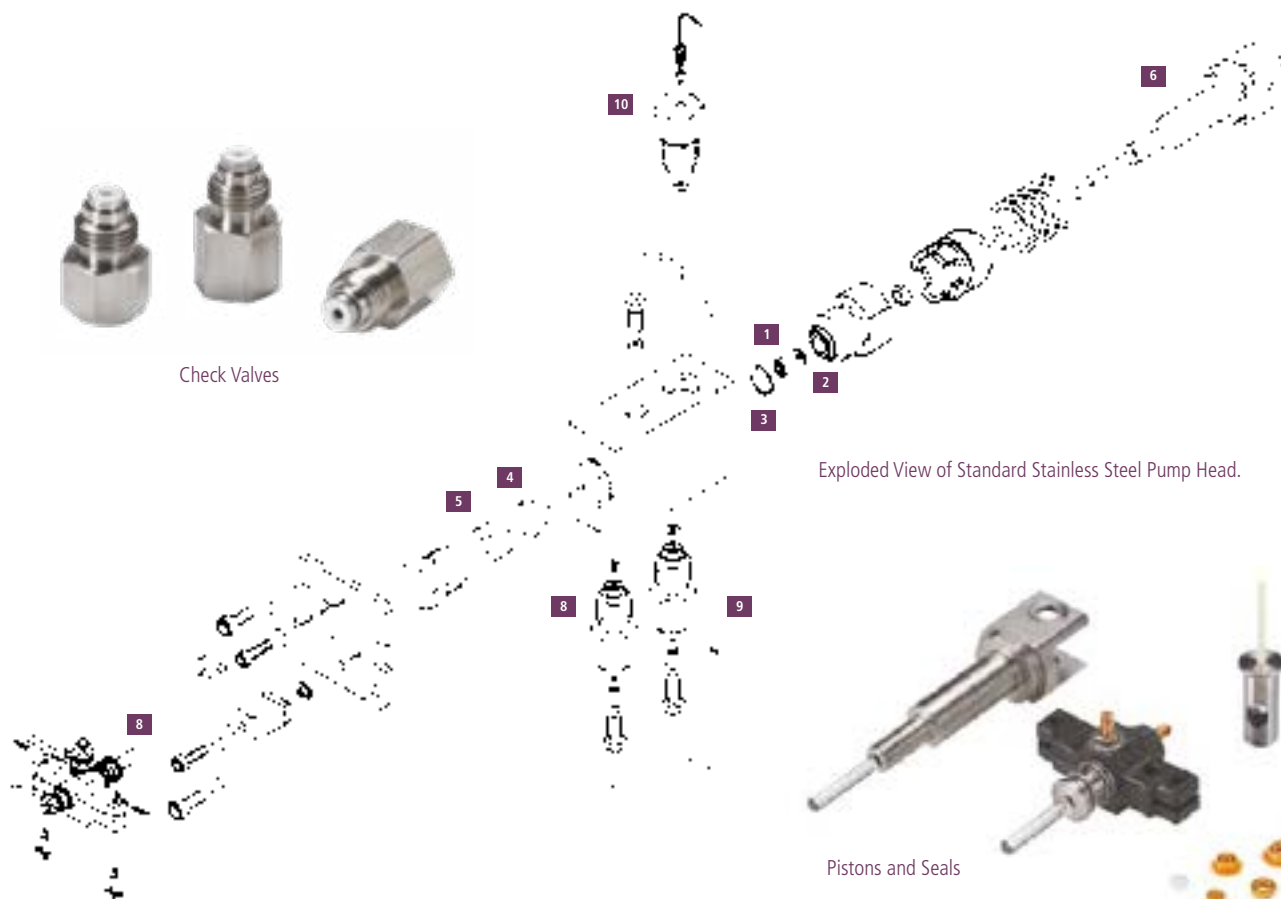

Exploded View of Standard Stainless Steel Pump Head.



Pistons and Seals

FX-15, FX-20 UHPLC Pump Accessories

Description	Part No.
Replacement 0.5 µm Filter Frits for FX-15 (pkg. 4)	N2911224
High Pressure FX-15 Piston Seal Kit (Need 4 per FX-15)	N2911221
Piston Wash Bottle Kit	N2601616
2,500 µL Sample Syringe Starting Kit	N2930313

FX-10, FX-15 and FX-20 UHPLC System Accessories

Description	Color	Size (cm)	Part No.
ID PEEK Tubing			
0.004 in.	Black	50	N2916200
0.005 in.	Red	50	N2916056
0.004 in.	Black	76	N2916260
0.005 in.	Red	66	N2916262
Connector Tubing, Stainless Steel			
Flexar ISO/Binary/Quaternary Pump to Autosampler			N2916210
Dual Mixer Connection (≤ 250 µL)			N2916216
Dual Mixer Connection (≤ 350 µL)			N2916217
FX-10 Pump A (Upper) to T-mixer			N2916213
FX-10 Pump B (Lower) to T-mixer			N2916214
FX-10 Purge Valve to Filter/Scavenger			N2916212
FX-10 Injector to Column			N2916215
FX-10 Pump A (Upper) to Dual Mixers			N2916218
FX-10 Pump B (Lower) to Dual Mixers			N2916219
FX-15 Pump to In-line Mixer			N2916222
FX-15 Pump to Dual Mixers			N2916224
FX-15 Injector to Column, Standard			N2916223
FX-15 Injector to Column, 33 cm			N2916201
3 cm Scavenger Cartridge Holder			02580178
Spheri-5 Scavenger Columns (pkg. 5)			02580202
30 mL Priming Syringe			09904849
FX-15 C18 Scavenger Column Kit			N2910765
FX-15 C18 Scavenger Columns (pkg. 2)			02580223

Flexar Pump Solvent Upgrade Kits

The unique design of the PerkinElmer Flexar Pump allows it to easily be upgraded for additional solvent capability right in your laboratory as your needs change. Installation of the kit by a PerkinElmer Service and Support is recommended, but not included. Contact your local PerkinElmer representative for more information.

Description	Part No.
Binary to Quaternary Upgrade Kit	N2910344
Isocratic to Binary Upgrade Kit	N2910342
Isocratic to Quaternary Upgrade Kit	N2910343

Flexar SS Sample Loops



Sample Loops

For Flexar FX UHPLC Autosampler (up to 18,000 psi operation)

Stainless Steel loops required for use with FX-10 or FX-20/FX-15 systems operating above 6,200 psi.

Description	Size	Part No.
Sample Loop, Stainless Steel	2 µL	N2936071
Sample Loop, Stainless Steel	5 µL	N2936056
Sample Loop, Stainless Steel	10 µL	N2936057
Sample Loop, Stainless Steel	20 µL	N2936058
Sample Loop, Stainless Steel	50 µL	N2936059
Sample Loop, Stainless Steel	100 µL	N2936060
Sample Loop, Stainless Steel	200 µL	N2936061
Sample Loop, Stainless Steel	500 µL	N2936062
Sample Loop, Stainless Steel	1 mL	N2936063
Sample Loop, Stainless Steel	2 mL	N2936064
Sample Loop, Stainless Steel	5 mL	N2936065

Flexar PEEK Sample Loops

Flexar LC Autosamplers (up to 6,200 psi operation)

These loops are compatible with all standard Flexar autosamplers as well as Series 225 autosamplers. PEEK loops cannot be used above 6,200 psi operation therefore are NOT compatible with standard Flexar autosamplers. Stainless steel loops required for use with FX-10 or FX-20/ FX-15 UHPLC systems operating above 6,200 psi.

Description	Size	Part No.
PEEK Sample Loop	2 µL	N2936072
PEEK Sample Loop	5 µL	N2936073
PEEK Sample Loop	10 µL	N2936074
PEEK Sample Loop	20 µL	N2936075
PEEK Sample Loop	50 µL	N2936076
PEEK Sample Loop	100 µL	N2936077
PEEK Sample Loop	250 µL	N2936078
PEEK Sample Loop	500 µL	N2936079
PEEK Sample Loop	1 mL	N2936080
PEEK Sample Loop	2 mL	N2936081
PEEK Sample Loop	5 mL	N2936082

Flexar Autosamplers

Features and Benefits

- Injects sample volumes as little as 1 µL at pressures up to 18,000 psi with the FX UHPLC Autosampler
- Loads sample in only 8 seconds (in partial fill mode)
- Three injection modes: full loop, partial fill and µL-pickup with no sample waste and excellent reproducibility
- Peltier cooling/heating mode option for operation at 4 °C to 40 °C. Will reach 4 °C ± 2 °C, achievable even at ambient temperatures up to 25 °C



All Flexar autosamplers can be upgraded in the field for Peltier cooling and heating and they all include:

- 100-sample tray
- 100 2 mL vials
- 100 2 mL screw top cap with cross slit vial septum
- Tubing to connect to waste reservoir
- I/O cable (Pump Start/Ready-In)
- Service Manager SW CD
- User's manual
- Nuts and ferrules
- All fuses for 120–240 V
- All cables required for connection to a TotalChrom or Chromera Operating Environment

Flexar Autosamplers and Upgrade Kits

Description	Part No.
Flexar LC Autosampler	
High throughput autosampler with exceptionally low carryover. Operates up to 6,100 psi (420 bar). Provides flexible injection modes: full-loop, partial-fill and µL-Pickup (no sample waste). Peltier cooling and heating options available as field upgrades. Comes standard with 100 µL loop and 250 µL sample flush syringe	N2930660
Flexar Peltier LC Autosampler	
High throughput autosampler with exceptionally low carryover. Operates up to 6,100 psi (420 bar). Provides flexible injection modes: full-loop, partial-fill and µL-Pickup (no sample waste). Built-in Peltier cooling comes standard. Peltier heating option available as field upgrade. Comes standard with 100 µL loop and 250 µL sample flush syringe	N2930661
Flexar FX UHPLC Autosampler	
High throughput UHPLC autosampler with exceptionally low carryover. Operates up to 18,000 psi (1,241 bar). Provides flexible injection modes: full-loop, partial-fill and µL-Pickup (no sample waste). Built-in Peltier cooling comes standard. Peltier heating option available as field upgrade. Comes standard with 10 µL loop and 250 µL sample flush syringe	N2930664
Field Upgrade Peltier Kits	
Flexar and Series 225 Upgrade Kit (from standard to Peltier Cooling option)	N2930672
Flexar and Series 225 Upgrade Kit (from standard to Peltier Cooling and Heating option)	N2930673
Flexar and Series 225 Upgrade Kit (from Peltier Cooling to Peltier Cooling and Heating option)	N2930669

Flexar Autosampler Trays and Accessories

Description	Part No.
25-Position 6 mL Vial Sample Tray	N2936045
80-Position 2 mL Vial plus (5) 6 mL Vial Tray (for derivatization)	N2936046
80-Position 2 mL Vial Tray with Dilution Tray	N2930676
96-Well Microtiter Adapter	N9302562
96-Well 'Deep-well' Microtiter Adapter	N9302560
96-Well 7 mm Pre-slit Silicone Plate Mat/Seal	N9302555
96-Well 'Deep' Microtiter Plate Adaptor (Supports Dual Microtiter Plates)	N2936048
96-Well 'Shallow' Microtiter Plate Adaptor (Supports Dual Microtiter Plates)	N2936049
384-Well Microtiter Adapter	N2936050
100-Position 2 mL Vial Sample Tray	N2936042
(200) 0.2 mL Microvial plus (5) 2 mL Vial Tray	N2936043
250 µL Syringe Tip Replacements (pkg. 10)	N2936003
Flexar/225 Biocompatible Upgrade Kit (w/ valve)	N2930675
1/16 in. OD x 0.038 in. ID PTFE Tubing (AS Transfer Line)	02506495

Flexar Autosampler Valve Maintenance Parts

Description	Flexar LC (6000 psi) Part No.	Flexar UHPLC (18000 psi) Part No.
Rotor Seal	N2936021	N2932001
Stator	N2936022	N2932002

Description	Part No.
Flexar UHPLC (18000 psi) Autosampler Valve Upgrade Kit	N2936023
Flexar Analytical LC (6000 psi) Autosampler Valve	N2936020

Peltier Tray Accessories

100-Position Peltier Temperature-Controlled Tray Accessory

100 standard 2 mL vials. Temperature controlled from 4 – 60 °C within ± 1 °C directly from Autosampler keypad – or from TotalChrom Workstation – Client/Server.

Description	Part No.
100-Position Peltier Temperature-Controlled Tray Accessory	N2930035

Peltier Temperature Controller



Controller Unit required for operation of either 100-position or Double Microtiter Peltier trays.

Description	Part No.
Peltier Temperature Controller	N2930036
100-Position Peltier Temperature-Controlled Tray Accessory	N2930035

High Pressure Analytical Static Mixers

Static Mixers are important in facilitating complete mobile phase blending, resulting in improved retention performance. These mixers should be used as part of FX10, or FX15 LC systems, where high pressure blending is required. Mixers incorporate a highly efficient cross-flow shearing mechanism which produces vortex shear mixing over a wide range of volumes. They are now offered in 18,000 psi pressure max flavor.

A good first choice selection is a volume of about half the flow rate volume. For example, when pumping at a 0.5 mL/min flow rate, a 350 μ L mixer provides good mixing with very good baseline stability.

Description	Part No.
50 μ L In-Line High Pressure Mixer Assembly, Stainless Steel	N2911200
150 μ L In-Line High Pressure Mixer Assembly, Stainless Steel	N2911201
250 μ L In-Line High Pressure Mixer Assembly, Stainless Steel	N2911202
350 μ L In-Line High Pressure Mixer Assembly, Stainless Steel	N2911205
500 μ L In-Line High Pressure Mixer Assembly, Stainless Steel	N2911203
Binary High Pressure T-Mixer, Stainless Steel, 50 μ L	N2911212
Binary High Pressure T-Mixer, Stainless Steel, 350 μ L	N2911210
Binary High Pressure T-Mixer, Stainless Steel, 500 μ L	N2911211
T-connector, Stainless Steel	N2911127

LX-50 Instrument Spares

The PerkinElmer QSight® LX50 UHPLC system is the perfect complement to our QSight LC/MS/MS platform. Featuring a high precision autosampler, an advanced UHPLC solvent delivery module and a flexible column temperature module, the QSight LX50 UHPLC delivers the performance required for even the most demanding analyzes.



QSight LX50 Precision Sampling Module

Description	Part No.
Valco Ferrule, 1/16" (pkg. 10)	N2992100
Valco Nut, 1/16" (pkg. 10)	N2992101
Sample Needle, Stainless Steel	N2992102
7 µL Sample Needle, PEEKsil	N2992103
500 µL Tefzel Buffer Tubing	N2992104
200 µL Tefzel Buffer Tubing	N2992105
QSight Valve Rotor Seal for UHPLC Injection Valve	N2932001
Nut, 1/16" for Collapsible Ferrule	N2992108
Collapsible Ferrule	N2992109
100 µL Syringe with Metal Screw Connection	N2992110
250 µL Syringe with Metal Screw Connection	N2992111
200 µL Stainless Steel Valco Loop	N2936061
10 µL Stainless Steel Valco Loop	N2936057
20 µL Stainless Steel Valco Loop	N2936058
50 µL Stainless Steel Valco Loop	N2936059
Peek One-Piece Hex-Head Nut	N2992117
Two Plate Carrier Sample Tray	N2992122
Standard Vial Tray, 108 Positions	N2992123

QSight LX50 Solvent Delivery Module

Description	Part No.
Seal Replacement Tool	N2991100
Hastelloy Steel Tubing, 1/16" Pump-to-Pump	N2991101
Stainless Steel Tubing, 1/16" Valve-to-Purge Pump A	N2991102
Stainless Steel Tubing, 1/16" Valve-to-Mixer	N2991103
Stainless Steel Tubing, 1/16" Valve-to-Purge Pump B	N2991104
Hastelloy Steel Tubing, 1/16" Pump A-to-Valve	N2991105
Hastelloy Steel Tubing, 1/16" Pump B-to-Valve	N2991106
Piston Cartridge Replacement Kit	N2991107
Flangless Nut + Ferrule, Brown, 1/8" (pkg. 10)	N2991108
Flangless Nut+Ferrule, Black, 1/8" (pkg. 10)	N2991109
Flangless Nut+Ferrule, 1/16" (pkg. 10)	N2991110
High Pressure Seal	N2991111
Check Valve Cartridge, Single	N2991112
Outlet Filter, 2 µm	N2991113
PM Kit Pump, 120 Liters or Yearly	N2991114
PM Kit Pump, 60 Liters	N2991115
Inlet Check Valve Housing Assembly	N2991120
Outlet Check Valve Housing Assembly	N2991121
Rotor Seal, Purge Valve 20.000psi	N2991128
Lubrication Kit	N2991136

QSight LX50 Column Temperature Module

Description	Part No.
Rotor Seal for Selection Valve	N2993109
Stainless Plug, 1/16"	N2993112

QSight LC/MS/MS Instrument Spares



PerkinElmer's QSight™ LC/MS/MS provides a high sensitivity triple quadrupole solution that enables high levels of efficiency and productivity to meet both standard and regulatory requirements.

Features and Benefits

- Self-cleaning StayClean™ technology
- Dual-source ion probes for flexible method development
- Easy-to-use and learn Simplicity™ software to streamline workflow

Ion Source Accessories

Description	Part No.
Additional ESI Probe	BC001283F
Additional APCI Probe	BC002312F
ESI Source Needle	BC004866F
APCI Source Needle	BC004868F

Tuning Solutions

Description	Part No.
100-200 Series Tuning Solution	BC004850
LC Infusion Kit	BC002931

Uninterruptable Power Supply Systems

With the Security Plus Series, you get much more protection and a higher comfort level than you get with most other UPS systems. The Security Plus Series also provides complete power conditioning and, because the Security Plus Series features on-line inverter design, added peace of mind. Regardless of input fluctuations, the Security Plus Series ensures that the output remains continuous and regulated.

Description	Part No.
QSight UPS System	N9306749



Noise Enclosure and Reduction Cover

Laboratories can be loud and noise in labs is distracting, stressful and potentially harmful to your hearing. While noise in labs may not be frequently talked about, it is something you should be concerned with.

Noise enclosure for SC40 and reduces perceived operator noise level by approximately 4 to 5 dB (A) Fits on **MZ321147**.

Description	Part No.	Depth (in./cm)	Width (in./cm)	Height (in./cm)	Height with Oil Tray (in./cm)	Enclosure Weight (lbs/kg)	Oil Tray Weight (lbs/kg)
Noise Enclosure Including Dolly	MZ321146	29.15/74	16.75/42.5	23.25/59	26.97/68.5	30.8/14	16.75/8

Genius Gas Generators

With curated and dedicated gas solutions for PerkinElmer, PEAK Scientific has developed optimal performing gas generators for your lab. The generators are engineered for your instrument to deliver the consistent flow and purity you demand, at the push of a button. If you're looking for a gas generator that you can rely on, is cost efficient, and highly efficient in streamlining your workflow – look no further than PEAK. With training and certification from PEAK, our PerkinElmer engineers are prepared for available services from installation, preventative maintenance, and general needs, we've got you covered worldwide. With us, you can be assured your lab is running smoothly – day to day, analysis to analysis.

Genius XE QSD

Nitrogen and Air Generator for PerkinElmer QSight® Dual Source LC/MS/MS

Advanced technology coupled with robust features, Genius XE QSD provides a quality standalone nitrogen solution custom designed to meet the requirements of our QSight Dual Source LC/MS/MS.



Featuring dual outlets (nitrogen and air), the generator was built to reduce size, noise, and heat emissions. Genius XE QSD has been tested and validated by our trusted engineers for use with the QSight and accompanied by factory pre-set pressures which allows for flows to meet the precise demands of our system.

Features and Benefits

- Multi-Stage Drying Filtration to efficiently remove moisture and contaminants, providing a consistent quality of gas
- Low environmental lab impact with low noise and heat emissions
- Next-generation high performance premium compressors
- Intuitive LED Service Indication
- ECO (Electronic Compressor Optimisation™) technology for low energy consumption and compressor durability
- Fixed annual maintenance schedule
- One year manufacturer's warranty

Description	Genius XE QSD
Part Number	N2800014
Nitrogen Maximum Flow	16 L/min @ 5.52 bar (0.57 cfm @ 80 psi)
Air Maximum Flow	67 L/min @ 7.58 bar (2.37 cfm @ 110 psi)
Dewpoint	Nitrogen ≤ -40 °C Dry Air ≤ -20 °C
Gas Outlets	2 x ¼" BSPP
Drain Outlet	1 x ¼" BSPP
Particles	<0.01 µm
Phthalates	None
Suspended Liquids	None
Operating Temperature	15 °C (59 °F) to 30 °C (86 °F)
Electrical Requirements	220-240 V ± 10% 50/60 Hz
Power Consumption	1.64 kVA
Heat Output	<5545 BTU
Noise Level	57dB(A) @ 1 m
Dimensions (HxWxD)	700 x 570 x 897 mm 27.6 x 22.5 x 35.4 in.
Weight	153 kg

Genius 1025

Nitrogen and Air Generator for PerkinElmer Instrumentation

With up to 15 L/min of LC/MS grade nitrogen and up to 35 L/min of air being produced in a single output, the Genius 1025 was specifically designed to meet the requirements of our QSight Triple Quad 110 and 210 Single Source LC/MS/MS systems.



This gas generator was outfitted using membrane technology to produce LC/MS grade purity and an internal air dryer to be an all-in-one solution.

Features and Benefits

- Self-contained solution with integrated compressors so no need for an external air supply
- Economical and efficient source of nitrogen/dry air with low lifetime running costs
- Easy to use – gas at the push of a button
- One year on-site warranty

Description	Genius 1025
Part Number	N2800012
Maximum Flow	Up to 15 L/min Nitrogen and up to 35 L/min Dry Air
Min/Max Pressure	Up to 80 psi Nitrogen and up to 110 psi Dry Air
Gas Outlets	2 x ¼" BSPP
Maximum Relative Humidity	80% Non-Condensing
Maximum Altitude	2000 m
Particles	<0.01 µm
Phthalates	None
Suspended Liquids	None
Operating Temperature	5 °C (41 °F) to 30 °C (86 °F)
Electrical Requirements	230 V ± 10% 50/60 Hz 7A
Power Consumption	<1,265 VA
Heat Output	3,925 BTU/Hr
Noise Level	57dB(A) @ 1m
Dimensions (HxWxD)	713 x 600 x 750 mm 28.1 x 23.7 x 29.6 in.
Weight	108.5 kg / 239.3 lbs
Shipping Weight	137 kg / 302.1 lbs

Ultra Clean Gas Filters and Kits for LC/MS

To meet the high flow needs of the LC/MS system, the hydrocarbon or moisture filled cartridges are positioned and placed in parallel. The incoming gas stream is split equally between the cartridges and the two streams are re-joined after purification but before the gas exits the base plate. Get up and running with speed and benefit from increased sensitivity by removing unwanted moisture and hydrocarbons.

Ultra-High Capacity Hydrocarbon Filter Bundle

Up to 20 L/min of hydrocarbon-free nitrogen per minute.



Capacity	
HC	24 g (as <i>n</i> -butane)
Description	Specification
Outlet Gas Quality (%)	> 99.9999
Maximum Pressure	15 bar (217 psi)
Maximum Flow	20 L/min
Usable For	Nitrogen
Dimensions	24 cm x Ø 4.4 cm
Weight	0.26 Kg
Estimated Lifetime	3 to 6 months
Part No.	N9306823

Ultra-High Capacity Moisture Filter Bundle

High Flow moisture filters are ideal for central purifying solutions.



Moisture in carrier gas lines will prematurely degrade oxygen and hydrocarbon traps and increase detector noise. As a precaution, we highly recommend installing a moisture trap before the hydrocarbon and oxygen traps on all carrier gas lines.

Capacity	
H ₂ O	14.4 g
Description	Specification
Outlet Gas Quality (%)	> 99.9999
Maximum Pressure	15 bar (217 psi)
Maximum Flow	20 L/min
Usable For	Inert carrier gas, He, H ₂ , N ₂ , Ar, Air
Dimensions	24 cm x Ø 4.4 cm
Weight	0.26 Kg
Estimated Lifetime	3 to 6 months
Part No.	N9306824

Ultra Clean Filter Kits for LC/MS



Description	Qty.	Part No.
Ultra Clean 2 High Flow Hydrocarbon Filter Kit – 1/4 in. Brass: Includes (1) 2 position high flow base plate with 1/4 in. Brass inlet/outlet fittings, (2) High Flow Hydrocarbon Traps, and a 1/4 in. Brass Particle Filter	Kit	N9306840
Ultra Clean 2 High Flow Hydrocarbon Filter Kit – 1/4 in. Stainless Steel: Includes (1) 2 position high flow base plate with 1/4 in. Stainless Steel inlet/outlet fittings, (2) High Flow Hydrocarbon Traps, and a 1/4 in. Brass Particle Filter	Kit	N9306841

Ultra Clean Filter Base Plates for LC/MS



Description	Qty.	Part No.
Ultra Clean Base Plate 1 Position – 1/4 in. Brass	1	N9306800
Ultra Clean Base Plate 1 Position – 1/8 in. Brass	1	N9306801
Ultra Clean Base Plate 1 Position – 1/4 in. Stainless Steel	1	N9306802
Ultra Clean Base Plate 1 Position – 1/8 in. Stainless Steel	1	N9306803
Ultra Clean Base Plate 2 Position – 1/4 in. Brass	1	N9306804
Ultra Clean Base Plate 2 Position – 1/8 in. Brass	1	N9306805
Ultra Clean Base Plate 2 Position – 1/4 in. Stainless Steel	1	N9306806
Ultra Clean Base Plate 2 Position – 1/8 in. Stainless Steel	1	N9306807
Ultra Clean Base Plate 3 Position – 1/4 in. Brass	1	N9306810
Ultra Clean Base Plate 3 Position – 1/8 in. Brass	1	N9306811
Ultra Clean Base Plate 3 Position – 1/4 in. Stainless Steel	1	N9306812
Ultra Clean Base Plate 3 Position – 1/8 in. Stainless Steel	1	N9306813

Replacement Filter Bundles for LC/MS

Description	Qty.	Part No.
Ultra Clean High Flow Hydrocarbon Filter Bundle: Includes (2) High Flow Hydrocarbon Filters	1 Bundle of 2 Cartridges	N9306823
Ultra Clean High Flow Moisture Filter Bundle: Includes (2) High Flow Moisture Filters	1 Bundle of 2 Cartridges	N9306824

Ultra Clean Replacement Individual Cartridge Filters for LC and LC/MS

Description	Qty.	Part No.
Ultra Clean Moisture Filter	1	N9306814
Ultra Clean Oxygen Filter	1	N9306815
Ultra Clean Hydrocarbon Filter	1	N9306816
Ultra Clean Combi (Hydrocarbon/Moisture) Filter	1	N9306818
Ultra Clean Triple (Oxygen/Moisture/Hydrocarbon) Filter	1	N9306819
Ultra Clean Triple (Oxygen/Moisture/Hydrocarbon) Helium-specific Filter	1	N9306820
Ultra Clean Triple (Oxygen/Moisture/Hydrocarbon) Hydrogen-specific Filter	1	N9306822

Base Plates

Ultra Clean High Flow Base Plates for LC/MS



Description	Qty.	Part No.
Ultra Clean High Flow Base Plate 2 Position – 1/4 in. Brass: Includes 1/4 in. Stainless Steel Particle Filter	1	N9306808
Ultra Clean High Flow Base Plate 2 Position – 1/4 in. Brass: Includes 1/4 in. Stainless Steel Particle Filter	1	N9306809

Accessories

Particle Filter for LC/MS



Description	Qty.	Part No.
Ultra Clean 0.5 Micron Particle Filter – 1/4 in. Brass	1	N9306856
Ultra Clean 0.5 Micron Particle Filter Cup Replacement Pack	12	N9306857

Ultra Clean Base Plate Fittings for LC/MS



Description	Qty.	Part No.
Ultra Clean High Flow Connector Set – 1/4 in. Brass	6	N9306850
Ultra Clean High Flow Connector Set – 1/4 in. Stainless Steel	6	N9306851

Ultra Clean Base Plate Flush Cap Replacement Set for LC/MS



Description	Qty.	Part No.
Ultra Clean High Flow Flush Cap Replacement Set	2	N9306853

Wall Mounting Bracket for All Cartridge Base Plates



Description	Qty.	Part No.
Ultra Clean Wall-Mounting Bracket Set	1	N9306855

Replacement O-rings for All Cartridge Base Plates



Description	Qty.	Part No.
Ultra Clean Base Plate O-ring Replacement Set	20	N9306854

High Capacity Hydrocarbon Trap



Description	Part No.
High Capacity Hydrocarbon Trap	N9301208

- Eliminates potential hydrocarbon background to insure best LC/MS results
- Contains 750 cc of preconditioned activated charcoal
- Stainless steel body. 1/4 in. brass compression fittings with ferrules for installation
- Maximum pressure 200 psi
- Recommended flow rate up to 2 Liters/minute
- Will remove hydrocarbon impurities (50 ppm or less) from inert gases, nitrogen and hydrogen at room temperature to low ppb range
- Capacity of 67 g of hydrocarbons C5 and heavier
- 10 µm stainless steel porous frits protect gas stream from particulates
- Individually helium leak tested. Shipped filled with helium
- 2 in. OD x 20 in. L (including fittings)
- Weight 3.5 lb/1.6 kg
- Maximum flow rate 57 SLPM, reduces hydrocarbons < 5 ppb at outlet

Series 200/785A and Series 200 EP Flow Cells

These flowcells provide the highest detection limits possible for your sample. The 6 mm pathlength flowcell has been optimized for lower-dispersion LC analysis and is the perfect choice when using narrowbore, 2.1 mm or microbore, 1 mm columns. The 3 mm pathlength is the choice for semiprep LC to avoid detector saturation at high-solute concentrations.

UV/Vis and PDA Flowcells and Assemblies

Description	Size	Part No.
Flowcells for 785A and Series 200 UV/Vis Detectors		
Flowcell	8 mm x 12 μ L	29000542
Flowcells for Series 275 PDA Detectors		
Flowcell Assembly (Dual-Lensed)	6 mm x 2.4 μ L	N2920166
Flowcells for Series 200EP PDA Detectors		
Flowcell	10 mm x 15 μ L	N2920126
Flowcell Assembly	10 mm x 15 μ L	N2920160
Flowcells for Series 200 PDA Detectors		
Flowcell	10 mm x 12 μ L	N2922107

Series 200 Pump Seal Kits

Description	Part No.
Series 200 Standard Pressure Piston Seal Replacement Kit Includes: Seals (4), Backup Rings and O-rings	N2910383
Micro pump Piston Seal Replacement Kit Includes: Seals and O-rings	N2910384

Series 200 Detector Lamps

Our extensive quality control and inspection process demands the very best quality sources. Choosing a PerkinElmer deuterium, tungsten or xenon source provides outstanding ultraviolet and true visible performance.



Series 200/200 EP
Photo Diode Array Detector Lamp

- Exceptional performance anywhere in the detector's 190 – 700 nm wavelength range
- Lamp changes are quick and easy due to a unique self-aligning lamp mount

UV/VIS Detector Lamps

Description	Part No.
Series 200/200a, 785A UV/VIS Detector Lamps	
Deuterium Lamp	N2920149
Tungsten Lamp	N2920146
LC-295 UV/VIS Detector Lamps	
Deuterium Lamp	02712266

Refractive Index Detector Lamps

The Flexar Series 200/200a Refractive Index lamps, with its deflection-type design, allows sensitive detection of these compounds with low noise and drift characteristics.

Description	Part No.
Series 200/200a	
Refraction Index (RI) Lamp	02712273

Photo Diode Array Detector Lamps

The Series 200/200a EP Photo Diode Array Detector provides true UV/VIS detection and high resolution spectral data. The excellent signal-to-noise characteristics make it ideally suited for low-volume or low concentration samples.

Components	Part No.
Series 200/200a EP	
Deuterium Lamp (PDA)	N2925030
Deuterium Lamp (PDA Plus)	09290900
Tungsten Lamp	N2922011
Series 200/200a	
Deuterium Lamp	N2922046
Tungsten Lamp	N2922011
LC-135C/235	
Detector Lamp	N2351285

Fluorescence Detector Lamps

The major benefit afforded by fluorescence detection is the inherent high sensitivity of the technique coupled with outstanding specificity. The Series 200a Fluorescence Detector provides signal to noise ratio of >700:1 from trace analysis using a 150 W xenon source.

Components	Part No.
Series 200/200a	
Xenon Lamp	N2922082
Festoon Lamp	04969486

Series 200 Seals, Pistons and Check Valves

Check valves, which include a sealing washer, are easy to install using the optional Torque Wrench kit. For all PerkinElmer pumps an intermediate check valve is required. The input check valve, which is identical, should be ordered.

Description	Series 200 (6000 psi)		
	Standard Stainless Steel Part No.	Micropump Stainless Steel Part No.	Biocompatible Titanium Part No.
1 Standard High Pressure Piston Seal	09907324	09923367 [†]	09907338
1 High Pressure Piston Seal – Chemically Resistant	09907345		
2 High Pressure Piston with Seal Backup Ring	02542076	†	
3 High Pressure Piston Seal PTFE O-ring	09902128	09902128	09902018
4 Low Pressure Piston Seal		09923366	09907339
5 Low Pressure Piston Seal Backup Guide Bushing	02542313	N2915006	
6 High Pressure Piston	N2600124	N2910511	N2600124
7 Low Pressure Piston	N2600104	N2910512	N2600104
8 Inlet Check Valve	02540177	02540177	N2600226
9 Intermediate Check Valve	02540177	02540177	N2600226
10 Outlet check Valve	02540197	02540197	N2600192

* Refer to Users Manual for complete illustrated parts list.

† High Pressure Piston Seal Backup ring (2) is included with the Standard High Pressure Piston Seal (1). Refer to page 158 for exploded diagram details.

Series 200 Maintenance Kits and Tools

Description	Part No.
Biocompatible Piston Seal Replacement Kit Includes: Four Seals, Backup Rings, and O-rings	N2910385
Piston Seal Replacement Kit Includes: Four Seals, Backup Rings, and O-rings	N2910383
Pulse Compensator Repair Kit Includes: Diaphragm, Elastomer Plug, and Seal	N2600313
Series 200 Pump Maintenance Kit Includes: Fuses, Seals, O-rings, and Seal Tools	N2910345
Micropump Piston Seal Replacement Kit	N2910384
Check Valve Torque Wrench	02540871
Seal Removal Tool	N2601295
Insertion Tool	N2601503

Series 200 PEEK Sample Loops

For Series 200/225 LC Autosamplers (up to 6,200 psi operation)

These loops are compatible with all standard Series 225 autosamplers. PEEK loops cannot be used above 6,200 psi operation therefore are NOT compatible with standard Flexar autosamplers.

Description	Size	Part No.
PEEK Sample Loop	2 µL	N2936072
PEEK Sample Loop	5 µL	N2936073
PEEK Sample Loop	10 µL	N2936074
PEEK Sample Loop	20 µL	N2936075
PEEK Sample Loop	50 µL	N2936076
PEEK Sample Loop	100 µL	N2936077
PEEK Sample Loop	250 µL	N2936078
PEEK Sample Loop	500 µL	N2936079
PEEK Sample Loop	1 mL	N2936080
PEEK Sample Loop	2 mL	N2936081
PEEK Sample Loop	5 mL	N2936082

Rheodyne Valves

Bio Injection Valve

Model 9725 is inert and well-suited to the chromatography of biological molecules, including applications with aggressive mobile phases. This valve is useful in all applications in which metal contact with the mobile phase and or sample should be avoided. This valve uses PEEK vent lines and a PTFE rotor seal and can be operated in a pH range from 0 – 14.

Description	Part No.
9725 Injection Valve for Series 200 Autosampler	N9306020

Rheodyne™ 8125 Low-Dispersion Stainless Steel Injection Valve

Ideal for use in an LC/MS system, the model 8125 is designed for 1 and 2 mm microbore columns and can also be used with conventional analytical (3 to 5 mm) columns. Small flow passages produce low dispersion, maintaining the high mass sensitivity inherent in micro columns.

Description	Part No.
8125 Low-Dispersion Stainless Steel Injection Valve	N9306021

Rheodyne™ 7725 Analytical Injection Valve

Inject from 1 µL to 5 mL with high accuracy and precision, with the Rheodyne 7725 and 7725i valves. Rheodyne 7725 and 7725i valves are versatile injectors and can use both partial-filling and complete-filling methods for loading the sample loop. Wide port angles of the 7725/7725i valve provide improved access to fittings. Sample loop with a 2 µL internal capacity is also available. In a clean system, the 7725/7725i typically can make more than 30,000 injections before requiring replacement of the rotor seal.

Description	Part No.
7725 Injection Valve for Series 200 Autosampler	N9306019
7725i Injection Valve with Internal Switch	N9306017

Microsyringes (for manual injection)

Syringes are used for accurate and precise liquid delivery. Each syringe is hand-fitted to assure maximum accuracy. Our syringes are composed of glass barrels and precision stainless steel needles. The needle features a blunt tip, required for use with a Rheodyne injector.

Description	Part No.
10 µL Syringe	09904937
25 µL Syringe	09904823
50 µL Syringe	09904941
100 µL Syringe	09904822
Rheodyne 22-Gauge Blunt Needle with Luer Hub	09904943

Rheodyne Valves Spare Parts

	Description	Model 9725 Part No.	Model 7725 Part No.
1	Needle Guide S200 Autosampler Manual Valve ISS-100	N2931054 09904800	N2931054 09904800
2	Needle Port Tube	09904805	09904805
3	Rotor Seal Vespel Tefzel PEEK	09904802 N9302677 N9306044	09904802 N9302677 N9306044
4	Stator Face Assembly PEEK and Ceramic	N9306047	N9306047
5	Stator PEEK Stainless Steel Titanium	N9306046	N9306045

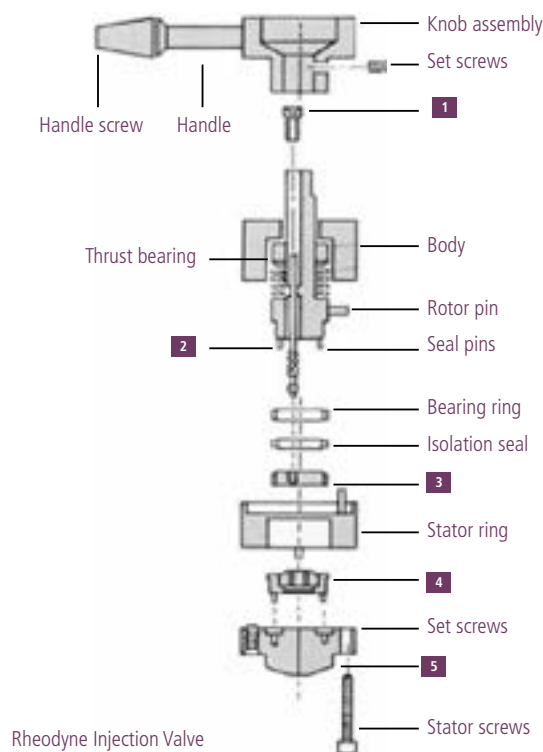

Rheodyne Injection Valve

PEEK Sample Loops for Rheodyne Valves

PEEK Sample Loops avoid many of the problems associated with stainless steel sample loops. Metal loops will often absorb sample components resulting in inaccurate quantitative results. In addition, metal loops may be corroded by high-salt buffers and chloride salts. Sample Loops are made from PEEK tubing and fittings. PEEK (Poly-Ether-Ether-Ketone) is a mechanically strong, chemically inert polymer ideal for HPLC applications where metal surfaces may interact with mobile phase or sample components. Each Sample Loop is supplied with two PEEK hex-head nuts and ferrules. These fittings grip the tubing in two locations for a more reliable connection.

Description	Model 9725 Part No.
5 µL PEEK Sample Loop	N9306033
10 µL PEEK Sample Loop	N9306034
20 µL PEEK Sample Loop	N9306035
50 µL PEEK Sample Loop	N9306036
100 µL PEEK Sample Loop	N9306037
200 µL PEEK Sample Loop	N9306038
500 µL PEEK Sample Loop	N9306039
1 mL PEEK Sample Loop	N9306040
2 mL PEEK Sample Loop	N9306041
5 mL PEEK Sample Loop	N9306042



Injector Valve Rotor Seals for both Series 200 Autosampler and Manual Injectors

For both the Rheodyne and Flom valves, rotor seals should be periodically replaced every 6 months to a year and are available in PEEK. For the Rheodyne valve, they are also available in Vespel. PEEK is more inert towards amines and other basic biomolecules/pharmaceuticals, exhibiting less sample carryover. However, Vespel is more resilient than PEEK, providing better wear life.

Description	Part No.
Flom Rotor Seal PEEK N9306068	00890873
Rheodyne 7725 Vespel Rotor Seal	09904802
Rheodyne 8125 Vespel Rotor Seal	10070900
Rheodyne 7725/9725 PEEK Rotor Seal	N9306044

Stainless Steel Sample Loops for 7725 Valve

Description	Model 7725 Part No.
5 µL Stainless Steel Sample Loop	N9306023
10 µL Stainless Steel Sample Loop	N9306024
20 µL Stainless Steel Sample Loop	N9306025
50 µL Stainless Steel Sample Loop	N9306026
100 µL Stainless Steel Sample Loop	N9306027
200 µL Stainless Steel Sample Loop	N9306028
500 µL Stainless Steel Sample Loop	N9306029
1 mL Stainless Steel Sample Loop	N9306030
2 mL Stainless Steel Sample Loop	N9306031
5 mL Stainless Steel Sample Loop	N9306032

Note: Loops are compatible with both manual valves and Series 200 Autosampler valves.

Internal Loop for 7725/9725 Valves

Description	Part No.
2 µL (PEEK and Ceramic)	N9306022

Solvent Sparger and Solvent Filters

Solvent filters remove unwanted particulate matter from the LC instrument. Spargers connect directly to the solvent delivery line and are easily removed for cleaning. The scavenger column is ideal for eliminating particulate material from solvents.



Solvent Filters

Solvent Spargers, Filters and Scavengers

Description	Size	Part No.
Solvent Reservoir Sparger		
Stainless Steel	10 µm	09903610
Titanium	10 µm	N2600070
Stainless Steel	40 µm	09903615
Titanium	40 µm	N2600089
Solvent Filters/Scavengers		
In-Line Solvent Filter System		09903606
In-Line Solvent Filter Replacement Kit		02540311
In-Line Solvent Filter System, Titanium		N2600259
Replacement 2 µm Titanium Filter Element		N2601477
Replacement Seal for In-Line Solvent Filter		N2601262
3 cm Scavenger Cartridge Holder		02580178
Spheri-5 C18 10 µm Scavenger Column (pkg. 5)		02580202
LC System Accessories		
Solvent Waste Cup		N2916019
Drain Cup		N2916085
90° Elbow Adapter, 1/4 in. ID HDPP		09220102
Tubing Clip (U-shaped, Polypropylene)		NX598006
Polypro Elbow Barbs		09220102
Large ID (11 mm) Silicone Tubing (5 ft)		N2916016
Manual Injector Bracket (Magnetic Clip-on)		N2931275

Pulse Compensators

The pulse compensator combines high-efficiency pulse smoothing with a low void volume. A Teflon diaphragm separates a reservoir filled by an RTV elastomer plug. Normal use will necessitate the eventual replacement of the diaphragm.

Description	Part No.
Diaphragm for Pulse Compensator	N2601316
Pulse Compensator Repair Kit Includes: Diaphragm, Elastomer Plug, and Seal	N2601313

Tubing

Tubing Accessories

Clean-Cut™ tubing tool is designed to cut PTFE, Tefzel® and polymers in general but, in particular, PEEK tubing. A unique safety locking mechanism secures the blade when not in use.

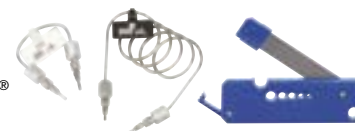

Description	Part No.
Clean-Cut Tubing Cutter	ED020015
Clean-Cut Tubing Replacement Blade	ED020016
Cable/Tubing clip (U-Shaped)	NX598006
Stick-on Tubing Organizer (Gray Plastic)	NX598006
PEEK Tubing Cutter, Incl. 5 Extra Blades	N9307820

PEEK Tubing

PEEK tubing has the strength required to withstand continuous use at HPLC pressure without swelling or bursting. Use PEEK with virtually any organic or inorganic liquid. PEEK tubing is not affected by halide salts, high-strength buffers or other aggressive mobile phases that degrade stainless steel.

Description	Size	Part No.
1/16 in. OD x 0.007 in. ID	5 ft	N9302678
1/16 in. OD x 0.010 in. ID	5 ft	N9302650
1/16 in. OD x 0.004 in. ID (Black)	50 cm	N2916200
1/16 in. OD x 0.005 in. ID (Red)	50 cm	N2916059
Connector Tubing, Flexar/FX Mixer to Injector, Stainless Steel		N2916211
Connector Tubing, Flexar ISO/Binary/Quaternary Pump to Autosampler, Stainless Steel		N2916210

Stainless Steel Tubing

Tubing is pre-cut and mirror-polished in 316 stainless steel.

SS-316 Tubing

Description	Size	Part No.
1/16 in. OD x 0.043 in. ID	6 ft	00873035
1/16 in. OD x 0.015 in. ID	6 ft	00873036
1/16 in. OD x 0.007 in. ID	3 ft	02540838
1/16 in. OD x 0.007 in. ID	20 cm	02711441
1/16 in. OD x 0.007 in. ID	50 cm	00891480

Tefzel Tubing

Description	Size	Part No.
1/16 in. OD x 0.030 in. ID	10 ft	N9301029

Fittings and Ferrules

High-Performance Fingertight Fittings

This PEEK Fingertight® fitting is the toughest with regard to chemical resistance and pressure. This high-performance Fingertight fitting is recommended for the most demanding applications and will resist pressures up to 6,000 psi (400 bar). Made from a single piece of PEEK, the size permits tightening without tools.



Description	Part No.
PEEK One-Piece Fingertight® Fitting	ED020005

Fittings, Nuts and Ferrules

Stainless steel nuts are available in both Parker-Hannifin and Rheodyne™ formats. The nuts are used to connect 1/16 in. OD stainless steel tubing and feature a 10 – 32 thread size. PerkinElmer also offers select SSI fittings for 1/16 in. OD tubing in 1/4 – 28 thread size.

Stainless Steel Fittings

Description	Part No.
Kel-F Reverse Ferrule, 1/8 in.*	09903771
Kel-F Ferrule, 1/16 in.*	09920382
Tefzel Nut, 1/16 in.*	09920381
Parker-Hannifin Ferrule, 1/16 in.	00873032
Parker-Hannifin Nut, 1/16 in.	09903980
Parker-Hannifin Nut and Ferrule Kit, 1/16 in. Includes: 6 Nuts and 6 Ferrules	00890945
Parker-Hannifin Zero-Dead-Volume Union with Nuts and Ferrules	09903289
Parker-Hannifin Medium-Stem Stainless Steel Nut	N2916202
Rheodyne™ Ferrule, 1/16 in.	09904947
Rheodyne™ Nut, 1/16 in. Long Body	09904974
Rheodyne™ Nut, 1/16 in. Short Body	09904956
Rheodyne™ Nut and Ferrule Kit, 1/16 in. Includes: 6 Ferrules, 3 Short Nuts and 3 Long Nuts	02540274
Tefzel Nut (for Reverse Ferrule), 1/8 in.*	N2601189
Tefzel Nut, 1/16 in.*	09920381
Valco Ferrule	09903891
OptiTech Reusable Nut/Ferrule for UHPLC (Fingertight to 15K psi)	N9306301
OptiTech Ferrule Replacements for UHPLC (pkg. 10)	N9306300
UHPLC 1/16 in. Reusable Fitting	N9307800

* The Tefzel and Kel-F fittings above are only for low pressure use (under 400 psi).



Fittings Kits

Recommended for users of a PerkinElmer Biocompatible LC system. Contains nuts, ferrules and unions.

Description	Part No.
Biocompatible Column Fittings for LC	N9301001

Fittings Kit for LC

The kit contains Rheodyne™ and SSI nuts and ferrules as well as Fingertight® II nuts and ferrules for tool-less installation. Zero-dead-volume unions are also included. In addition, you receive varying lengths of stainless steel tubing in 0.007 and 0.010 in. ID, as well as 0.30 in. ID Tefzel® tubing.

Description	Part No.
All-in-one Fittings Kit	N9301002

Operation Kit

Recommended for purchasers of their first LC. Includes tubing, union, fittings, syringe, basic LC book and test mix.

Description	Part No.
Operation Kit	00890873

Vacuum Degassing Kits

Using a solvent degassing system will extend the performance of your pump. PerkinElmer offers both vacuum degassing systems that can handle all your degassing requirements.

On-Line Vacuum Degasser Kit

This is a low-volume, high efficiency on-line module for the removal of dissolved gasses from HPLC solvents. The vacuum degasser is available in 3 and 5 channel models to support isocratic, binary and quaternary pumps as well as degassing of autosampler flush solvent.

Description	Part No.
3-channel Vacuum Degassing Package. Includes: a Vacuum Degasser, one 1 L Bottle with Cap, one 2 L Bottle with Cap, one Organizer Tray and Accessory	N2600571
5-channel Vacuum Degassing Package. Includes: a Vacuum Degasser, two 1 L Bottle with Caps, two 2 L Bottles with Caps, Solvent Tray and Organizer	N2600570
Binary Bottle Cap Kit. Includes: two Caps, Tubing, Fittings and Labels required for two Solvent Bottles	N2600522
Quaternary Bottle Cap Kit. Includes: four Caps, Tubing, Fittings and Labels required for four Solvent Bottles	N2600523

Liquid Chromatography Laboratory Bottle Kits

Description	Part No.
1 x 5 Liter Bottle with Cap and PTFE Insert, 2 Meters PTFE 1/8 in. Tubing and 1x10 µm Stainless Steel Solvent Frit	N2601610
1 x 2 Liter Bottle with Cap and PTFE Insert 1 Meter PTFE 1/8 in. Tubing and 1 x 10 µm Stainless Steel Solvent Frit	N2601611
1 x 1 Liter Bottle with Cap and PTFE Insert 1 Meter PTFE 1/8 in. Tubing and 1 x 10 µm Stainless Steel Solvent Frit	N2601612
1 x 0.5 Liter Bottle with Cap and PTFE Insert 1 Meter PTFE 1/16 in. Tubing and 1 x 40 µm Stainless Steel Solvent Frit	N2601613
1 Cap with PTFE Insert 1 Meter PTFE 1/8 in. Tubing and 1 x 10 µm Stainless Steel Solvent Frit	N2601614
1 Cap with PTFE Insert 1 Meter PTFE 1/16 in. Tubing and 1 x 40 µm Stainless Steel Solvent Frit	N2601615
1 x 0.5 Liter Bottle with Cap and Dual PTFE Insert 2 pcs of 2 Meter PTFE 1/8 in. Tubing (Piston Wash Function)	N2601616
1 Cap with Dual PTFE Insert 2 pcs of 2 Meter PTFE 1/8 in. Tubing and 1 x 10 µm Stainless Steel Solvent Frit (Piston Wash Function)	N2601617

Replacement Vacuum Degasser Bottles

Description	Part No.
1 L Glass Bottle	N2600497
2 L Glass Bottle	N2600498

Starter Kits

UHPLC – General Starter Kit

Description	Part No.
UHPLC – General Starter Kit	N2930801

Contents	Qty./Pkg.	Part No.
Open-End Wrench	2	09907233
Adjustable Wrench (Double Ended, 1/4 in. x 5/16 in.)	1	N9301326
Reversible (Slotted/Phillips) Screw Driver, 5.5 in.L x 0.4 in. W	1	N9301480
ZDV Parker-Hannifin Stainless Steel Union	1	09903289
Medium-Stem Parker-Hannifin Stainless Steel Nuts	10	09903980
1/16 in. Parker-Hannifin Stainless Steel Ferrules	10	00873032
1/16 in. Valco Stainless Steel Ferrules	6	09903891
Finger-Tight Fittings, PEEK, 5.5K psi Max (pkg. 5)	1	N9307822
Nut/Ferrule-Ti Hybrid (Hand-Tight Fitting to 13K psi, Wrench-tight to 20K psi)	1	N9306301
1/16 in. Tefzel Nuts	2	09920381
1/16 in. Tefzel Reverse Ferrules	2	09920382
1/8 in. Tefzel Nuts	4	N2601189
1/8 in. Tefzel Reverse Ferrules	4	09903771
PEEK Tubing Cutter (Includes 5 Extra Blades)	1	N9307820
50 cm x 0.005 in. ID 1/16 in. Stainless Steel Tubing	3	02507060
5 ft. x 0.004 in. ID 1/16 in. PEEK Tubing, Black	1	N2916261
5 ft. x 0.005 in. ID 1/16 in. PEEK Tubing, Red	1	N2916263
30 mL Priming Syringe	1	09904849
2 mL Clear Write-On Vials w/ 9 mm Pre-Slit PTFE/Silicone Caps (pkg. 100)	1	N9300701
Cable/Tubing Organizer Clip	3	NX598006

HPLC – General Starter Kit

Description	Part No.
HPLC – General Starter Kit	N2930802

Contents	Qty./Pkg.	Part No.
Open-End Wrench	2	09907233
Adjustable Wrench (Double Ended, 1/4 in. x 5/16 in.)	1	N9301326
Reversible (Slotted/Phillips) Screw Driver, 5.5 in.L x 0.4 in. W	1	N9301480
ZDV Parker-Hannifin Stainless Steel Union	1	09903289
Medium-Stem Parker-Hannifin Stainless Steel Nut	10	09903980
1/16 in. Parker-Hannifin Stainless Steel Ferrule	10	00873032
1/16 in. Valco Stainless Steel Ferrules	6	09903891
Rheodyne Stainless Steel Nut, Short Stem	2	09904956
Rheodyne Stainless Steel Nut, Long Stem	2	09904974
1/16 in. Rheodyne Stainless Steel Ferrule	4	09904947
1/16 in. Tefzel Nuts	2	09920381
1/16 in. Tefzel Reverse Ferrules	2	09920382
1/8 in. Tefzel Nuts	4	N2601189
1/8 in. Tefzel Reverse Ferrules	4	09903771
Finger-Tight Fittings, PEEK, 4K psi Max	6	09920513
PEEK Tubing Cutter (Includes 5 Extra Blades)	1	N9307820
50 cm x 0.005 in. ID 1/16 in. Stainless Steel Tubing	1	02507060
50 cm x 0.007 in. ID 1/16 in. Stainless Steel Tubing	2	00891480
5 ft. x 0.007 in. ID 1/16 in. PEEK Tubing, Yellowish-Tan	1	N9302650
5 ft. x 0.005 in. ID 1/16 in. PEEK Tubing, Red	1	N2916263
30 mL Priming Syringe	1	09904849
2 mL Clear Write-On Vials w/ 9 mm Pre-Slit PTFE/Silicone Caps (pkg. 100)	1	N9300701
Cable/Tubing Organizer Clip	3	NX598006

GC Columns

PerkinElmer offers a wide selection of superior quality products designed to work with your PerkinElmer instruments. Our precision designed products deliver the peace of mind that comes from knowing that you'll get the results you need.

Quick Reference Index

	Page
➤ Cross Reference Charts	65-66
➤ GC Capillary Column Cutter	64
➤ GC Columns for GC/MS	78-81
➤ Elite-1ms	78
➤ Elite-5ms	79
➤ Elite-17ms, Elite-35ms	80
➤ Elite-624ms	81
➤ General Purpose GC Columns	67-77
➤ Elite-1	67
➤ Elite-5	68
➤ Elite-17	69
➤ Elite-35	70
➤ Elite-200	71
➤ Elite-225	72
➤ Elite-624	73
➤ Elite-1301	74
➤ Elite-1701	75
➤ Elite-WAX, Elite-MWAX	76
➤ Elite-WAX ETR	77
➤ High Temperature GC Columns	82
➤ Miscellaneous Accessories	88
➤ Speciality Columns	83-88
➤ Elite-BAC Advantage	83
➤ Elite-VMS, Elite-XLB	84
➤ Elite-Volatiles, Elite-CLPesticides	85
➤ Elite-502.2, Elite-RX, Elite-Betacyclodextrin, Elite-SimDist, Elite-608	86
➤ Elite-TPH, Elite-PONA, Elite-FFAP, Elite-5 Amine, Elite-2330/Elite-23, Elite-MTBE, Elite-2560	87
➤ Elite-Carbon	87
➤ PLOT Columns	88

➤ CLICK THE ARROWS TO VIEW EACH PAGE

Blood Alcohol Columns

The Elite-BAC Advantage columns are optimized for selectivities guaranteed to resolve ethanol, internal standards, and frequently encountered interferences.

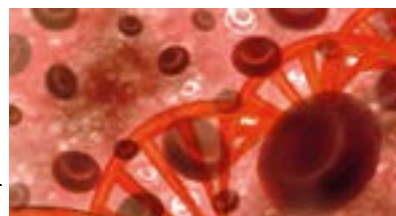

➤ VIEW PAGE

Elite MS Columns

The Elite range of MS columns are engineered for extremely low bleed for MS detectors, providing optimum sensitivity. They cover a wide range of polarities and applications.



➤ VIEW PAGE

GC Column Cutter

PerkinElmer's capillary column cutting tool ensures you make a perfect cut of your GC column, first time, every time. The rotating diamond blade with a built in magnifier to verify a square cut, affords a precise clean cut of fused silica columns.



➤ VIEW PAGE

Elite Guard Columns

Using the Elite-Guard or the Elite-Siltek Guard Column lengthens the life of the capillary column and improves the analyte focusing.

➤ VIEW PAGE

➤ BACK TO MAIN INDEX

➤ ORDER ONLINE



Clarus® 590/690 GC

Sensitive, high-capacity, high-throughput GC systems delivering the power and functionality needed to meet your analytical goals. A robust autosampler delivers easy access to two injector ports, while the Clarus 690's patented high-performance oven delivers the fastest heat-up and cool-down of any oven in the business.



TurboMatrix™ Headspace and Headspace Trap

TurboMatrix Headspace and high-sensitivity Headspace Trap samplers provide unparalleled precision and ease of use for numerous GC or GC/MS volatile-analysis applications. Different models offering a range of capacities are available to satisfy the requirements of virtually any laboratory.



Torion® T-9 Portable GC/MS

The world's smallest portable GC/MS, Torion T-9 allows you to test samples where hazardous events occur: No sample processing, packaging, and prep time. You simply respond, collect, analyze, and identify in the field. And that means remedial action 70 times faster than with conventional labs.



Clarus® SQ 8 GC/MS

With the flexibility to choose your level of sensitivity and dynamic range, the Clarus SQ 8 GC/MS eliminates background noise, maximizes analyte signals, and enables you to reconfigure between EI and CI, simply and quickly.



TurboMatrix Thermal Desorbers

The five different TurboMatrix Thermal Desorbers allow you to match throughput and technology to your laboratory and applications needs. Use this clean technique to simplify and speed up a wide range of GC applications.

Finest Quality High-Strength Fused Silica

Why Choose Fused Silica?

Many factors influence the quality of a column. Fused silica is considered to be the purest form of glass, with fewer metal oxides (Lewis acid sites) and hydrogen bonding (surface silanol) groups. The stationary phase is cross linked (polymerized) and also bonded to the surface of the column to provide a high degree of stability, resulting in lower bleeding of the stationary phase at elevated temperatures. The superior inertness of the column means that acidic and basic compounds can be analyzed on the same column.

Selecting the Right Stationary Phase

The inherent efficiency (large number of theoretical plates) of capillary columns allows you to choose from relatively few types of phases, compared to the many varieties of packed columns previously required. Perhaps more importantly, because capillary columns are more efficient, you will see superior resolution resulting in narrower, taller peaks that allow easier integration from your data system. Identification of small peaks are facilitated by a reduced baseline bleed and lower baseline noise. Non-polar Elite-1 columns from PerkinElmer will preferentially retain non-polar compounds, whereas the PerkinElmer Elite-200 column phase provides high selectivity for analytes containing lone pair electrons, such as nitro and carbonyl groups. Elite-WAX polyethylene glycol columns are highly selective toward polar compounds such as alcohols.

GC Capillary Column Cutter

Use PerkinElmer's capillary column cutting tool to ensure a perfect cut of your GC column, first time, every time. The rotating diamond blade with a built in magnifier to verify a square cut, affords a precise clean cut of fused silica columns. Suitable for use with 0.25 mm ID to 0.53 mm ID tubing, (0.78 mm OD maximum).



Description	Part No.
GC capillary cutting tool	N6107245
Maintenance kit Contains replacement cutting wheel, O-rings and tool to open the cutter	N6107246



What Length Do I Need?

Typically capillary columns are available in lengths from 15 to 105 meters. The longer the column the more resolving power, but this also increases the analysis time. Doubling a column length only increases resolution by approximately 40%. Under isothermal conditions, the analysis time will double if using temperature programmed analysis retention times are more dependent on the temperature than on the column length. We provide columns in the most popular lengths of 5, 10, 12, 15, 25, 30, 50, 60, 75, 100 and 105 meters depending upon the column ID.

Elite Guard Columns

Using the Elite-Guard or the Elite-Siltek Guard Column lengthens the life of the capillary column and improves the analyte focusing. The 5 m length of deactivated uncoated fused silica is connected to the inlet end of the capillary column and traps nonvolatile residues, preventing them from collecting at the head of the analytical column. This length of fused silica contains no stationary phase adding only a minimal amount of time to the analysis.

Description	Tubing ID (mm)	Length (m)	Part No.
Elite Siltek Guard	0.25	5	N9316607
Elite Siltek Guard	0.32	5	N9316608
Elite Siltek Guard	0.53	5	N9316609
Elite Guard	0.25	5	N9316603
Elite Guard	0.32	5	N9316604
Elite Guard	0.53	5	N9316606

Cross Reference Chart by Phase

PerkinElmer	Phase Composition	USP	Agilent®	Alltech®	Machery-Nagel®	Ohio Valley®	Phenomenex®	Quadrex®	Restek®	SGE®	Supelco®
Elite-1	Dimethyl polysiloxane	G1, G2, G38	HP-1, DB-1, CP-Sil 5 CB	007-1AT-1, EC-1	OPTIMA 1	OV-1	ZB-1	007-1	Rtx-1, Mtx-1	BP1	SPB-1
Elite-1ht	Dimethyl polysiloxane	G1, G2, G38	DB-1ht	AT-1ht			ZB-1HTinferno		Rxi-1HT		
Elite-1ms	Dimethyl polysiloxane (low bleed)	G1, G2, G38	HP-1, HP-1ms, HP-1msUI, DB-1, DB-1MS, DB-1msUI, Ultra-1, VF-1ms, CP-Sil 5 CB	AT-1ms	OPTIMA 1 MS, OPTIMA 1 MS Accent		ZB-1, ZB-1ms	007-1	Rxi-1ms	BP-1	SPB-1, Equity-1
Elite-5	Diphenyl dimethyl polysiloxane	G27, G36	HP-5, DB-5, CP-Sil 8 CB	EC-5, AT-5	OPTIMA 5	OV-5	ZB-5	007-5	Rtx-5	BP5	SPB-5
Elite-5ht	Diphenyl dimethyl polysiloxane	G27, G36	DB-5ht, VF-5ht		OPTIMA 5HT		ZB-5HTinferno		Rxi-5HT	HT5	
Elite-5ms	1,4-bis(dimethylsiloxy)phenylene dimethyl polysiloxane	G27, G36	DB-5ms, DB-5msUI, VF-5ms, CP Sil 8 CB MS		OPTIMA 5 MS Accent	OV-5MS	ZB-5msi	007-5MS	Rxi-5Sil MS	BPX5	SLB-5ms
Elite-17	Phenyl methyl polysiloxane	G3	DB-17, CP Sil 24 CB	AT-50		OV-17		007-17	Rtx-50		SPB-50
Elite-17ht	Phenyl methyl polysiloxane	G3	DB-17ht								
Elite-17ms	Phenyl methyl polysiloxane	G3	HP-50+, DB-17, DB-17ht, DB-608, CP Sil 24 CB		OPTIMA 17		ZB-50		Rxi-17		SPB-17
Elite-35	Diphenyl dimethyl polysiloxane	G42	HP-35, DB-35, VF-35	AT-35, AT-35ms		OV-35	ZB-35	007-35	Rtx-35	BPX35, BPX608	SPB-35, SPB-608
Elite-35ms	Diphenyl dimethyl polysiloxane	G42	DB-35ms, DB35msUI		OPTIMA 35 MS		MR2		Rxi-35Sil MS	BPX35	
Elite-200	Trifluoropropylmethyl polysiloxane	G6	DB-210, DB-200, VF-200ms	AT-210	OPTIMA 210				Rtx-200		
Elite-225	Cyanopropylmethyl phenylmethyl polysiloxane	G7, G19	DB-225ms, CP Sil 43 CB	AT-225	OPTIMA 225	OV-225		007-225	Rtx-225	BP225	SPB-225
Elite-624	Cyanopropylphenyl dimethyl polysiloxane	G43	DB-1301, DB-624, VF-624ms, CP-1301	AT-624, AT-1301	OPTIMA 1301, OPTIMA 624	OV-624	ZB-624	007-1301, 007-624	Rtx-624	BP624	SPB-624
Elite-624ms	Unique phase	G43	DB-624, VF-624ms, CP-Select 624 CB		OPTIMA 624 LB		ZB-624		Rxi-624Sil MS	BP624	
Elite-1301	Cyanopropylphenyl dimethyl polysiloxane	G43	DB-1301, DB-624, VF-1301ms, VF-624ms, CP-1301	AT-624, AT-1301	OPTIMA 1301, OPTIMA 624	OV-1301	ZB-624	007-1301, 007-624	Rtx-624	BP624	SPB-624
Elite-1701	Cyanopropylphenyl dimethyl polysiloxane	G46	DB-1701R, DB-1701, CP Sil 19 CB, VF-1701ms, VF-1701 Pesticides	AT-1701	OPTIMA 1701	OV-1701	ZB-1701, ZB-1701P	007-1701	Rtx-1701	BP10	Equity-1701
Elite-WAX	Polyethylene glycol	G14, G15, G16, G20, G39	DB-Wax, CP Wax 52 CB, VF WAX	AT-WAXms, EC-WAX	OPTIMA WAX	Carbowax 20M	ZB-Wax	007-CW	Rtx-Wax	BP20	
Elite-WAX ETR	Polyethylene glycol	G14, G15, G16, G20, G39	HP-INNOWax, CP Wax 52 CB, VF-WAX MS	AT-WAX	OPTIMA WAX plus		ZB-WaxPLUS		Stabilwax		Supelcowax-10

Cross Reference Chart by Application

PerkinElmer	Applications	Agilent®	Alltech®	Machery-Nagel®	Ohio Valley®	Phenomenex®	Quadrex®	Restek®	SGE®	Supelco®
Elite-23	cis/trans FAMES and Dioxins	VF-23ms	AT-Silar90				007-23		BPX70	SP-2330, SP-2331, SP-2380
Elite-502	Volatile analytes by EPA Method 502.2	DB-502.2						Rtx-502.2		VOCOL
Elite-608	Semivolatile pesticides by EPA Method 608	DB-608, HP-608					007-608			SPB-608
Elite-2560	cis/transFAMES	HP-88, CP Sil 88						Rt-2560		SPB-2560
Elite-Alumina PLOT	Light hydrocarbons	Alumina PLOT								
Elite-BAC 1 Advantage	Blood alcohol testing	DB-ALC1				ZB-BAC1		Rtx-BAC Plus 1		
Elite-BAC 2 Advantage	Blood alcohol testing	DB-ALC2				ZB-BAC2		Rtx-BAC Plus 2		
Elite-CLPesticides	Organochlorine pesticides by EPA Methods 504, 608, 8081, 8082, and CLP	DB-CLP1						Rtx-CLPesticides		
Elite-CLPesticides2	Organochlorine pesticides by EPA Methods 504, 608, 8081, 8082, and CLP	DB-CLP2						Rtx-CLPesticides 2	Rtx-200	
Elite-Cyclosil B	Chiral separations									
Elite-FFAP	Free fatty acids	HP-FFAP, DB-FFAP, CP WAX58 CB, CP-FFAP CB	AT-AquaWax DA, AT-1000	PERMABOND FFAP, OPTIMA FFAP, OPTIMA FFAP Plus	OV-351	ZB-FFAP		Stabilwax-DA	BP-21	Nukol
Elite-Molesieve PLOT	Permanent gases									
Elite-PONA	Detailed analysis of petroleum naphtha	HP-PONA, DB-Petro, CP Sil PONA CB						Rtx-DHA	BP1PONA	Petrocol DH
Elite-Carbon	Permanent gases and light hydrocarbons									
Elite-SimDist	Simulated Distillation and Hydrocarbons – ASTM 2887	DB-2887, CP SimDist	AT-2887					Rtx-2887		Petrocol 2887, Petrocol EX2887
Elite-THP	Total petroleum hydrocarbons									
Elite-VMS	Volatiles Organic Pollutants by GC-MS for EPA Methods 8260,624,524	Unique Phase								
Elite-VRX	Volatile analytes by EPA Methods 502.2, 601, 602, 8010, 8020	DB-VRX								
Elite-XLB	Polychlorinated biphenyl analytes by EPA Methods 8082, 6008, PCB congeners	DB-XLB, VF-XMS				MR1, ZB-XLB		Rxi-XLB		

Elite-1

The Elite-1 100% dimethyl polysiloxane columns is a highly versatile, non-polar, cross-linked general purpose phase that is rugged, exhibiting long column lifetime, low bleed, and high maximum operating temperatures.

Features

- Temperature Range: -60 °C to 350 °C
- Equivalent to USP G1, G2, and G38 phases

Applications

- Ideal for analysis of non-polar petrochemical samples
- Also excellent for solvents, chemicals, flavors & fragrances, air toxins and pesticides

Elite-1 Structure

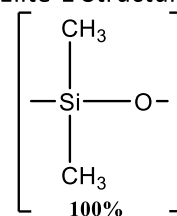

ID (mm)	df (µm)	Temp Limits (°C)	5 m Part No.	15 m Part No.	30 m Part No.	60 m Part No.	105 m Part No.
0.25	0.10	-60 to 330/350		N9316006	N9316009	N9316012	
	0.25	-60 to 330/350		N9316007	N9316010	N9316013	
	0.50	-60 to 330/350		N9316686	N9316685		
	1.00	-60 to 320/340		N9316008	N9316011	N9316014	
0.32	0.10	-60 to 330/350		N9316016	N9316022	N9316027	
	0.25	-60 to 330/350	N9316596	N9316017	N9316023	N9316028	
	0.50	-60 to 330/350			N9316021 ¹	N9316691	
	1.00	-60 to 320/340		N9316018	N9316024	N9316029	
	1.50	-60 to 310/330			N9316050	N9316580	
	3.00	-60 to 280/300		N9316019	N9316025	N9316030	
	5.00	-60 to 260/280		N9316020	N9316026	N9316031	
0.45	0.13	-60 to 330/350		N9316032			
	0.42	-60 to 310/330		N9316037	N9316041		
	1.27	-60 to 310/330		N9316034	N9316038	N9316042	
	2.55	-60 to 270/290		N9316035	N9316039		N9316043
	4.25	-60 to 260/280	N9316032	N9316036	N9316040		
0.53	0.15	-60 to 320/340		N9316045			
	0.50	-60 to 310/330		N9316049	N9316053		
	1.50	-60 to 310/330		N9316046	N9316050	N9316054	
	3.00	-60 to 270/290		N9316047	N9316051	N9315499	N9316692
	5.00	-60 to 270/290	N9316044	N9316048	N9316052		

ID (mm)	df (µm)	Temp Limits (°C)	10 m Part No.	12 m Part No.	20 m Part No.	25 m Part No.	50 m Part No.
0.05	0.05	-60 to 330/350	N9316056				
	0.20	-60 to 330/350	N9316057				
0.10	0.10	-60 to 330/350	N9316058				
	0.40	-60 to 320/340			N9316061		
0.18	0.18	-60 to 330/350	N9316001		N9316003		
	0.40	-60 to 320/340	N9316002		N9316004		N9316005 ²
0.20	0.33	-60 to 330/350		N9316062		N9316063	N9316064

¹ N9316021: Elite-1, 25M x 0.32 mm x 0.52 µm. ² The length of N9316005 is 40 m.

Elite-5

The Elite-5 is a 5% diphenyl/95% dimethyl polysiloxane stationary phase. It is regarded as a general purpose, low polarity phase that is the most popular GC stationary phase used for a wide variety of applications. A crosslinked phase in which all residual catalysts and low molecular weight fragments have been removed providing a tight mono-modal distribution and extremely low bleed.

Features

- Temperature Range: -60 °C to 350 °C
- Equivalent to USP G27 and G36 phases

Applications

- Drugs, pesticides and solvent impurities
- Hydrocarbons and PCBs
- Essential oils and semivolatiles

Elite-5 Structure

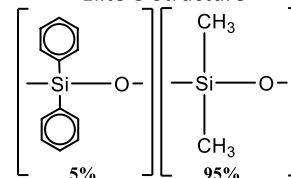

ID (mm)	df (µm)	Temp Limits (°C)	10 m Part No.	15 m Part No.	20 m Part No.	30 m Part No.	50 m Part No.	60 m Part No.
0.05	0.05	-60 to 325/350	N9316104					
	0.20	-60 to 325/350	N9316105					
0.10	0.10	-60 to 330/350			N9316108			
	0.40	-60 to 320/340			N9316109			
0.18	0.18	-60 to 330/350	N9316066		N9316068			
	0.4	-60 to 320/340	N9316067		N9316069		N9316071²	
0.20	0.33	-60 to 330/350	N9316110¹		N9316111¹		N9316112	
0.25	0.10	-60 to 330/350		N9316072		N9316075		N9316078
	0.25	-60 to 330/350		N9316073		N9316076		N9316079
	0.50	-60 to 330/350				N9316107	N6107815	
	1.00	-60 to 320/340		N9316074		N9316077		N9316080
0.32	NEW 0.10	-60 to 330/350		N9316081		N9316085		N9316089
	0.25	-60 to 330/350		N9316082		N9316086		N9316090
	1.00	-60 to 320/340		N9316083		N9316087		N9316091
0.45	0.13	-60 to 340/350						N9316097
	0.42	-60 to 310/330		N9316093		N9316096		
	1.27	-60 to 310/330		N9316092		N9316094		
	4.25	-60 to 260/280				N9316095		
0.53	0.50	-60 to 310/330		N9316099		N9316102		
	1.50	-60 to 310/330		N9316098		N9316100		N9316103
	5.00	-60 to 270/290				N9316101		

¹ The lengths of **N9316110** and **N9316111** are 12 m and 25 m respectively. ² **N9316071** use 40 m length column.

Industrial

Determination of sulfur compounds in air by online TD-GC/FPD.

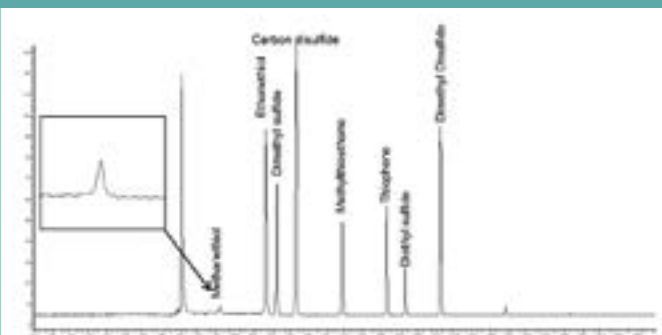

Recommended Column: Elite-5, 60 m x 0.32 mm x 0.25 mm, Part No. **N9316090**

Elite-17

The Elite-17 columns are general purpose, mid-polarity, (50%-phenyl)-methylpolysiloxane phases and incorporates a crosslinking technology for very low bleed and long column lifetimes.

Features

- Temperature Range: 40 °C to 330 °C
- Equivalent to USP G3 phase

Applications

- Herbicides and pesticides
- Phthalate esters, sterols and rosin acids

Elite-17 Structure

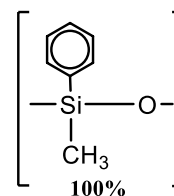

ID (mm)	df (μm)	Temp Limits (°C)	5 m Part No.	10 m Part No.	15 m Part No.	20 m Part No.	30 m Part No.	60 m Part No.
0.05	0.05	40 to 280/300		N9316138				
	0.10	40 to 280/300		N9316139				
0.10	0.02	40 to 280/300		N9316141				
	0.10	40 to 280/300		N9316140		N9316142		
	0.20	40 to 280/300				N9316143		
0.18	0.18	40 to 310/330		N9316113			N9316115	
	0.3	40 to 300/320		N9316114			N9316116	
0.25	0.15	40 to 300/320			N9316117		N9316120	
	0.25	40 to 300/320			N9316118		N9316121	N9316123
	0.50	40 to 290/310			N9316119		N9316122	
0.32	0.15	40 to 300/320			N9316124		N9316127	
	0.25	40 to 300/320			N9316125		N9316128	
	0.50	40 to 290/310			N9316126		N9316129	
0.45	0.85	40 to 270/290			N9316131		N9316132	N9316133
0.53	1.00	40 to 260/280			N9316135		N9316136	N9316137
	2.00	40 to 250/270	N9316134					

Elite-35

The Elite-35 columns are general purpose, mid-polarity columns that are coated with a crosslinked, (35%-diphenyl)-dimethylpolysiloxane commonly used for organochlorine pesticides, PDB congeners. It is a popular confirmation column for pesticides and herbicides, in conjunction with an Elite-5 or Elite-1701. The higher phenyl content results in useful elution order and retention time changes.

Features

- Temperature Range: 40 °C to 300/320 °C
- Equivalent to USP G42 phase

Applications

- Pesticides and herbicides
- Pharmaceuticals, sterols, rosin acids and phthalate esters

Elite-35 Structure

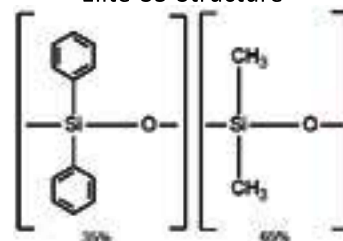

ID (mm)	df (µm)	Temp Limits (°C)	15 m Part No.	30 m Part No.
0.25	0.15	40 to 300/320		N9316144
	0.25	40 to 300/320		N9316145
0.32	0.25	40 to 300/320		N9316146
	0.50	40 to 290/310		N9316147
0.45	0.42	40 to 290/310		N9316150
	0.85	40 to 280/300	N9316148	N9316149
0.53	0.50	40 to 260/280	N9303929	N9316153
	1.00	40 to 260/280	N9316151	N9316152

Food and Flavor

Analysis of ethyl carbamate using GC/MS.

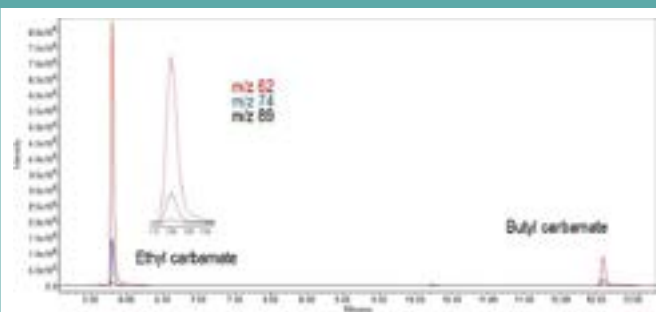

Recommended Column: Elite-35, 30 m x 0.25 mm x 0.25 µm
(Part No. **N9316145**)

Liner: 2 mm ID glass (no glass wool)

Elite-200

Elite-200 columns are comprised of a (trifluoropropyl)-methylpolysiloxane stationary phase that has a unique selectivity which changes elution orders and resolves compounds that phenyl, cyano, or Carbowax® phase cannot. These columns have accomplished many difficult separations not possible on any other bonded stationary phase. It offers exceptional thermal stability, low bleed, and superior inertness – even for active compounds such as phenols, and with sensitive detectors such as ECDs, NPDs, and MSDs. It is often used for the confirmation of phenols, nitrosamines, organochlorine pesticides, chlorinated hydrocarbons, and chlorophenoxy herbicides when paired with an Elite-5 column.

Features

- Temperature Range: 40 °C to 320/340 °C
- Equivalent to USP G6 phase

Applications

- Solvents, fluorocarbons, ketones and phenols
- Alcohols and drugs of abuse
- Chlorinated herbicides and pesticides

Elite-200 Structure

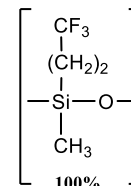

ID (mm)	df (μm)	Temp Limits (°C)	15 m Part No.	30 m Part No.	60 m Part No.
0.25	0.10	-20 to 320/340	N9316616	N9316617	
	0.25	-20 to 320/340	N9316618	N9316619	
	0.50	-20 to 310/330	N9316620	N9316621	
	1.00	-20 to 290/310	N9316622	N9316623	N9316624
0.32	0.25	-20 to 320/340	N9316625	N9316626	
	0.50	-20 to 310/330	N9316627	N9316628	
	1.00	-20 to 290/310	N9316629	N9316630	N9316631
	1.50	-20 to 280/300	N9316632	N9316633	N9316634
0.53	0.25	-20 to 310/330	N9316635	N9316636	N9316637
	0.50	-20 to 300/320	N9316638	N9316639	N9316640
	1.00	-20 to 290/310	N9316641	N9316642	N9316643
	1.50	-20 to 280/300	N9316644	N9316645	N9316646
	3.00	-20 to 260/280	N9316647	N9316648	N9316649

Elite-225

The Elite-225 is a general purpose column for the analysis of FAMES, carbohydrates, sterols and flavor compounds. The cyanopropyl-containing Elite-225 phase is slightly less polar than bonded polyethylene glycol (PEG) phases, but it can be used for many of the same applications. Improvements to the Elite-225 polymer have increased thermal stability, reduced bleed, and improved inertness. In other similar columns, the Carbowax® deactivation layer is not fully compatible with the cyanopropyl siloxane polymer, which can cause tailing of active compounds, and lower efficiency.

Features

- Temperature Range: 40 °C to 220/240 °C
- Equivalent to USP G7, G19 phases

Applications

- FAMES and carbohydrates
- Sterols and flavor compounds

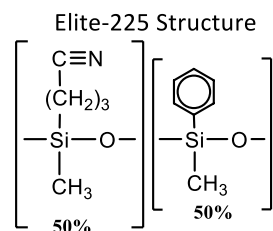

ID (mm)	df (μm)	Temp Limits (°C)	10 m Part No.	15 m Part No.	20 m Part No.	30 m Part No.	60 m Part No.
0.05	0.05	45 to 220/240	N9316186				
0.10	0.10	45 to 220/240			N9316187		
0.18	0.2	45 to 220/240	N9316172		N9316173		
0.25	0.15	45 to 220/240		N9316174		N9316176	N9305631
	0.25	45 to 220/240		N9316175		N9316177	
0.32	0.15	45 to 220/240		N9316178		N9316180	
	0.25	45 to 220/240		N9316179		N9316181	
0.45	0.85	40 to 200/220		N9316182		N9316183	
0.53	1.00	40 to 200/220		N9316184		N9316185	

Elite-624

The Elite-624 column is a specially engineered, low to mid-polarity (6%-cyanopropylphenyl)-dimethylpolysiloxane phase. The unique polarity of this phase makes it ideal for analyzing volatile organic pollutants and it is recommended in U.S. EPA methods. The Elite-624 phase produces greater than 90% resolution of the first six gases in EPA Methods 8260 and 524.2. This stationary phase is especially well-suited for EPA Method 524.2 since it resolves 2-nitropropane from 1,1-dichloropropanone, which share quantification ion m/z 43 and must be separated chromatographically.

Features

- Temperature Range: -20 °C to 240 °C
- Equivalent to USP G43 phase

Applications

- Volatile organic pollutants
- EPA methods 524.2 and 8260

Elite-624 Structure

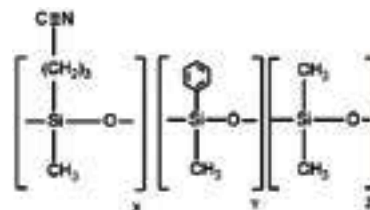

ID (mm)	df (µm)	Temp Limits (°C)	20 m Part No.	25 m Part No.	30 m Part No.	60 m Part No.	75 m Part No.
0.18	1.00	-20 to 240	N9316200				
0.20	1.12	-20 to 240		N9316209			
0.25	1.40	-20 to 240			N9316201	N9316202	
0.32	1.80	-20 to 240			N9316203	N9316204	
0.45	2.55	-20 to 240			N9316205		N9316206
0.53	3.00	-20 to 240			N9316207	N9305699	N9316208

Pharma

Residual solvents in pharmaceuticals by USP 467.

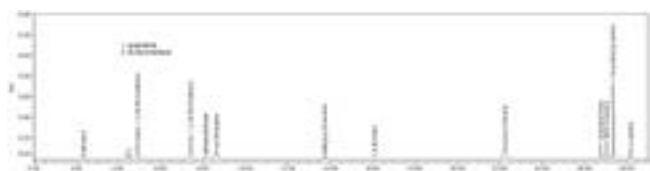

Elite-624, 30 m x 0.32 mm x 1.8 µm, Part No. **N9316203**

Environmental

Analysis of Volatile Organic Compounds (VOCs) in air using US EPA Method TO-17.

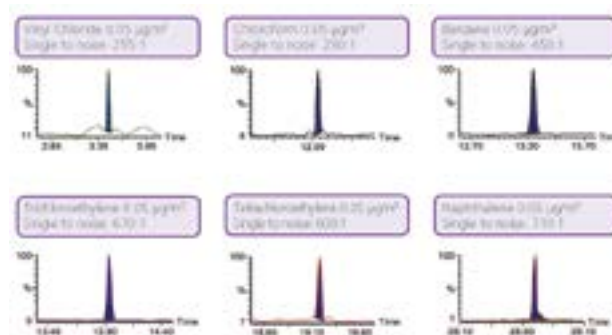

Recommended Column: Elite-624, 60 m x 0.25 mm x 1.4 µm, Part No. **N9316006**

Elite-1301

The Elite-1301 column is a general purpose low to mid-polarity phase commonly used for the analysis of residual solvents, alcohols, oxygenates and volatile organic compounds. Our polymer is fully characterized to ensure long-term reproducibility, column-to-column consistency, and low bleed – even with sensitive detectors such as ECD and MS.

Features

- Temperature Range: -20 °C to 280 °C
- Equivalent to USP G43 phase

Applications

- Residual solvents, alcohols
- Oxygenates, VOCs

Elite-1301 Structure

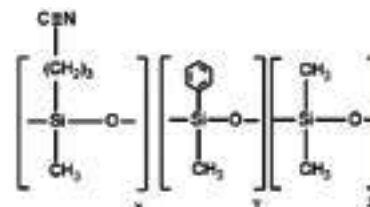

ID (mm)	df (µm)	Temp Limits (°C)	10 m Part No.	15 m Part No.	20 m Part No.	30 m Part No.	60 m Part No.
0.18	0.40	-20 to 280	N9316210		N9316211		
0.25	0.25	-20 to 280		N9316212		N9316214	N9316216
	1.00	-20 to 260/280				N9316215	N9316217
0.32	0.25	-20 to 280		N9316218		N9316220	N9316222
	1.00	-20 to 260/280		N9316219		N9316221	N9316223
0.45	0.85	-20 to 260/280		N9316224		N9316225	
0.53	1.00	-20 to 260/280		N9316226		N9316227	

Elite-1701

The Elite-1701 has a stationary phase of (14%-cyanopropylphenyl)-methylpolysiloxane. It is regarded as a good general purpose column for the analysis of alcohols, oxygenates, and pesticides. The mix of cyano and phenyl functional groups increases the polarity and offers a different elution order relative to less polar Elite-1 or Elite-5 columns. An Elite-1701 column is ideal for confirmation analysis in combination with an Elite-35 or Elite-5 column. The polymer is fully characterized to ensure long-term reproducibility, column-to-column consistency, and low bleed – even with sensitive detectors such as ECD and MS.

Features

- Temperature Range: -20 °C to 280 °C
- Equivalent to USP G46 phase

Applications

- Alcohols, oxygenates
- PCB congeners, pesticides

Elite-1701 Structure

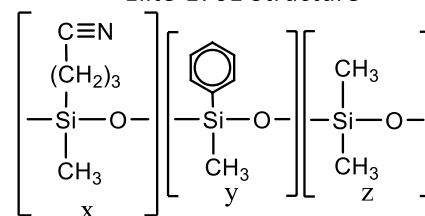

ID (mm)	df (μm)	Temp Limits (°C)	10 m Part No.	15 m Part No.	20 m Part No.	30 m Part No.	50 m Part No.	60 m Part No.
0.05	0.05	-20 to 280	N9316257					
	0.20	-20 to 280	N9316258					
0.10	0.10	-20 to 280				N9316259		
0.18	0.4	-20 to 270/280	N9316228		N9316229			
0.25	0.15	-20 to 280		N9316230				N9316236
	0.25	-20 to 280		N9316231		N9316234		N9316237
	1.00	-20 to 260/280		N9316232		N9316235		N9316238
0.32	0.15	-20 to 280		N9316239		N9316242		N9316246
	0.25	-20 to 280		N9316240		N9316243		N9316247
	1.00	-20 to 260/280		N9326141		N9316244	N9316245	N9316248
0.45	0.42	-20 to 260/270		N9316250		N9316252		
	0.85	-20 to 250/270		N9316249		N9316251		
0.53	0.50	-20 to 260/270		N9316254		N9316256		
	1.00	-20 to 250/270		N9316253		N9316255		

Elite-WAX

The Elite-WAX column, a Polar Polyethylene Glycol (PEG) stationary phase column, is a general purpose polar PEG phase commonly used for the analysis of polar compounds like alkenols, glycols and aldehydes. The operating temperature range up to 250 °C facilitates the analysis of compounds that have a wide volatility range. Selectivity of the Elite-WAX is comparable to other Carbowax® columns for compounds of intermediate to high polarity.

Features

- Temperature Range: 20 °C to 250 °C
- Equivalent to USP G14, G15, G16, G20 and G39 phases

Applications

- FAMES, Glycols
- Alkenols, aldehydes, solvents

Elite-WAX Structure

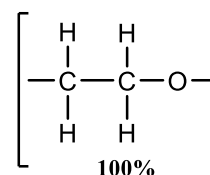

ID (mm)	df (μm)	Temp Limits (°C)	15 m Part No.	30 m Part No.	60 m Part No.
0.25	0.15	20 to 250	N9316399		N9316405
	0.25	20 to 250	N9316400	N9316403	N9316406
	0.50	20 to 250	N9316401	N9316404	N9316407
0.32	0.15	20 to 250	N9316408	N9316411	
	0.25	20 to 250	N9316409	N9316412	N9316416
	0.50	20 to 250	N9316410	N9316413	N9316417
0.45	0.42	20 to 250	N9316420	N9316422	
	0.85	20 to 240/250	N9316419	N9316421	N9316423
	1.70	50 to 230	N9316418		
0.53	0.50	20 to 250	N9316426	N9316428	
	1.00	20 to 240/250	N9316425	N9316427	N9316429

Food and Flavor

The determination of low levels of benzene, toluene, ethylbenzene, xylenes and styrene in olive oil.

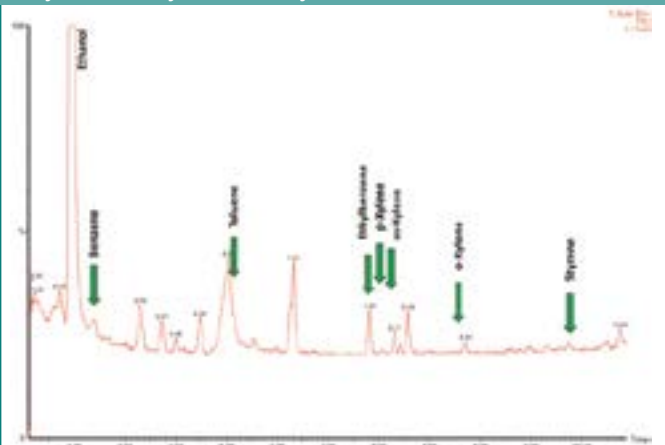

Recommended Column: Elite-WAX, 30 m x 0.25 mm x 1.0 μm (Part No. N9316485)

Elite-MWAX: Metal Column

ID (mm)	df (μm)	Temp Limits (°C)	30 m Part No.
0.53	1.00	20 to 240/250	N9316478

Elite-WAX ETR

The Elite-WAX ETR (Extended Temperature Range) columns are manufactured with a special bonding process that binds the Carbowax® polymer to the polar deactivated silica. This results in a low bleed WAX column that exhibits extended lifetimes even when repeatedly heated to 250 °C. The bonding mechanism makes this column rugged enough to stand up to repeated water injections and allows solvent washing to rejuvenate the column. The Elite-WAX ETR has a wide applicability including FAMES, flavor compounds, acrolein/acrylonitrile (EPA 603), oxygenated compounds, and impurities in water matrices.

Features

- Temperature Range: 40 °C to 250 °C
- Equivalent to USP G14, G15, G16, G20 and G39 phases

Applications

- FAMES, flavor compounds, essential oils
- Solvents, aromatics, alcoholic beverages
- EPA method 603

ID (mm)	df (µm)	Temp Limits (°C)	5 m Part No.	15 m Part No.	30 m Part No.	50 m Part No.	60 m Part No.
0.25	0.25	40 to 250		N9316547	N9316549		N9316551
	0.50	40 to 250		N9316548	N9316550		
0.32	0.25	40 to 250		N9316552	N9316555		N9316559
	0.50	40 to 250		N9316553	N9316556		N9316560
	1.00	40 to 240/250		N9316554	N9316557	N9316558	N9316561
0.45	0.85	40 to 250		N9316563	N9316564		N9316565
	1.70	40 to 230/250	N9316562				
0.53	1.00	40 to 240/250		N9316567	N9316569		N9316571
	2.00	40 to 220/250	N9316566	N9316568	N9316570		

Food and Flavor

Determination of omega-3 (n-3) and omega-6 (n-6) fatty acid composition in evening primrose oil and flax seed oil.

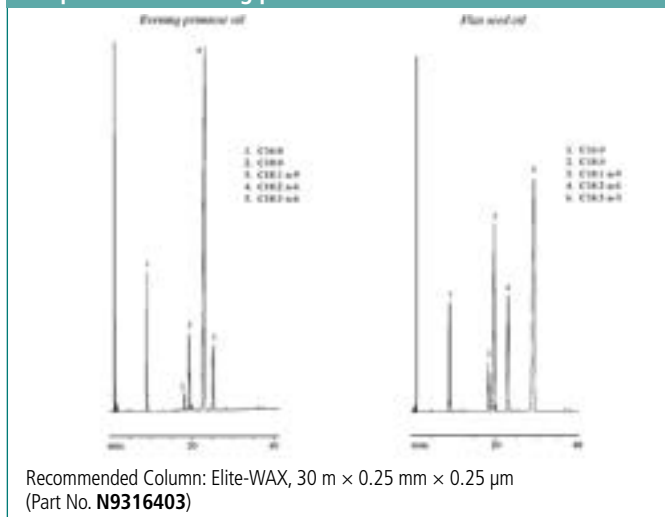

GC Columns for GC/MS

The Elite range of MS columns are engineered for extremely low bleed for MS detectors, providing optimum sensitivity. They cover a wide range of polarities and applications.

Elite-1ms

The Elite-1ms phase is a non-polar phase, (crosslinked dimethyl polysiloxane) designed to be robust for MS applications. With improved thermal stability and ultra low bleed provides increased sensitivity. It is regarded as a good general-purpose columns for arson accelerants, essential oils, hydrocarbons, pesticides, PCB congeners (e.g., Aroclor mixes), sulfur compounds, amines and solvent impurities.

Features

- Temperature range: -60 °C to 330/350 °C.
- Equivalent to USP G1, G2, and G38 phases

Applications

- Ideal for analysis of non polar petrochemical samples
- Also excellent for solvents, chemicals, flavors & fragrances, air toxins and pesticides

Elite-1ms Structure

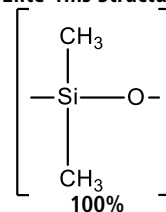

ID (mm)	df (μm)	Temp Limits (°C)	15 m Part No.	20 m Part No.	30 m Part No.	60 m Part No.
0.18	0.18	-60 to 330/350		N9305635		
	2.00	-60 to 330/350		N9305636		
0.25	0.25	-60 to 330/350	N9305637		N9305638	N9305639
	0.50	-60 to 330/350	N9305640		N9305641	N9305642
	1.00	-60 to 330/350	N9305643		N9305644	N9305645
0.32	0.25	-60 to 330/350	N9305646		N9305647	N9305648
	0.50	-60 to 330/350	N9305649		N9305650	N9305651
	1.00	-60 to 330/350			N9305652	N9305653
	4.00	-60 to 330/350			N9305654	

Elite-5ms

The Elite-5ms phase (1,4-bis(dimethylsiloxy)phenylene dimethyl polysiloxane) incorporates a phenyl group in the polymer backbone to improve thermal stability, reduce bleed and make the phase less prone to oxidation. This results in a phase that is inert to active compounds with extremely low bleed to meet the requirements of sensitive MS detectors. It is a general purpose column ideal for GC/MS analysis of semivolatiles, PAHs, chlorinated hydrocarbons, phthalates, phenols, amines, organochlorine and organophosphorus pesticides, drugs and solvent impurities.

Features

- Temperature Range: -60 °C to 350 °C
- Similar to USP G27 and G36 phases

Applications

- Drugs, pesticides and solvent impurities
- Hydrocarbons and PCBs
- Essential oils and semivolatiles

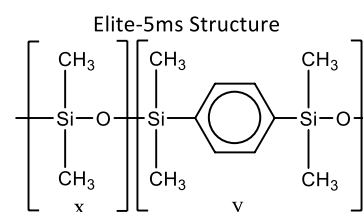

ID (mm)	df (μm)	Temp Limits (°C)	15 m Part No.	30 m Part No.	60 m Part No.
0.18	0.18	-60 to 325/340		N9316276 ¹	N9316277 ¹
0.20	0.33	-60 to 330/350	N9316301 ²	N9316302 ²	N9316303 ²
0.25	0.25	-60 to 330/350	N9316279	N9316282	N9316286
	0.50	-60 to 330/350		N9316284	
	1.00	-60 to 325/350	N9316280	N9316283	N9316287
0.32	0.25	-60 to 330/350	N9316289	N9316293	N9316297
	0.50	-60 to 330/350		N9316295	
	0.52	-60 to 330/350		N9316291 ³	
	1.00	-60 to 325/350	N9316290	N9316294	N9316298
0.53	1.50	-60 to 310/330	N9316299	N9316300	

¹ The lengths of **N9316276** and **N9316277** are 20 m and 40 m, respectively.

² The lengths of **N9316301**, **N9316302** and **N9316303** are 12 m, 25 m and 50 m, respectively.

³ The length of **N9316291** is 25 m.

Food and Flavor

The qualitative characterization of fruit juice flavor using a TurboMatrix Hs Trap and a Clarus SQ 8 GC/MS.

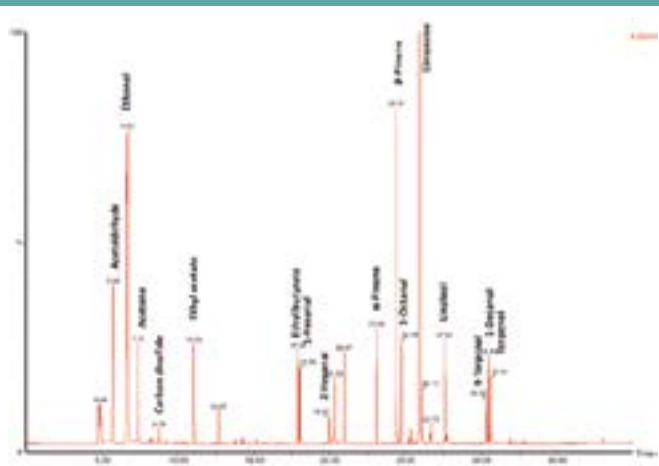

Recommended Column: Elite-5ms, 60 m x 0.25 mm x 1.0 μm, Part No. **N9316287**

Food

The preparation and analysis of polycyclic aromatic hydrocarbons in meat by GC/MS.

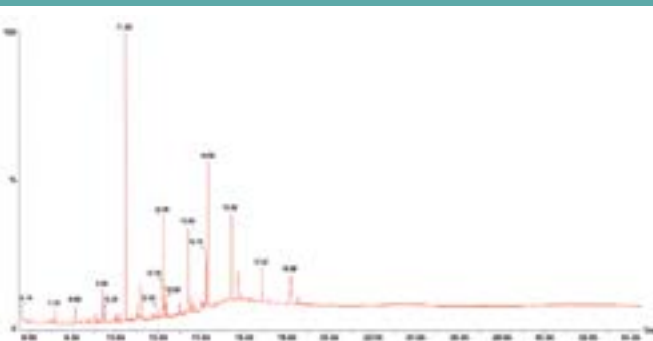

Column: Elite-5ms column, 30 m x 0.25 mm x 0.25 μm, Part No. **N9316282**
Liner Deactivated Liner, Part No. **N6502002**

Elite-17ms

The Elite-17ms columns are general purpose, mid-polarity columns that are coated with a crosslinked, (50%-diphenyl)-dimethylpolysiloxane engineered for very low bleed to meet the requirements of sensitive MS detectors.

Features

- Temperature Range: 40 °C to 300/340 °C
- Equivalent to USP G3 phase

Applications

- Herbicides and pesticides
- Phthalate esters, sterols and rosin acids

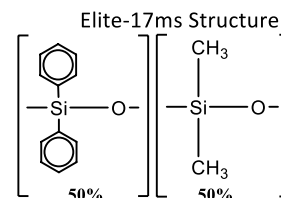

ID (mm)	df (μm)	Temp Limits (°C)	15 m Part No.	30 m Part No.	60 m Part No.
0.18	0.18	40 to 300/340	N9316534		
0.25	0.15	40 to 300/320	N9316535	N9316537	
	0.25	40 to 300/320	N9316536	N9316538	N9316539
0.32	0.15	40 to 300/320	N9316540	N9316542	
	0.25	40 to 300/320	N9316541		

Elite-35ms

The Elite-35ms columns are general purpose, mid-polarity columns offering extremely low bleed at higher temperatures. They are coated with a unique blend of linked dimethyl polysiloxanes and diphenyl polysiloxanes that are inert and selective for substituted polar compounds, such as drugs, pesticides, herbicides, PCBs and phenyls, while maintaining a similar selectivity and polarity as traditional Elite-35 phases.

Features

- Temperature Range: 50 °C to 340/ 360 °C
- Equivalent to USP G42 phase

Applications

- Pesticides and herbicides
- PCBs

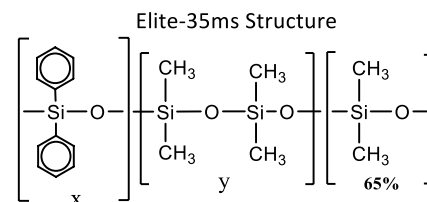

ID (mm)	df (μm)	Temp Limits (°C)	15 m Part No.	30 m Part No.
0.25	0.25	50 to 340/360	N9305686	N9305687
	0.50	50 to 340/360	N9305688	N9305689
	1.00	50 to 320/340	N9305690	N9305691
0.32	0.25	40 to 340/360	N9305692	N9305693
	0.50	40 to 340/360	N9305694	N9305695
	1.00	40 to 320/340	N9305696	N9305697

Elite-624ms

The Elite-624ms incorporates a unique proprietary blend of cyanopropyl and methyl siloxanes that results in a very inert, extremely low bleed and high thermal stability column. This column provides excellent peak shape for a wide range of compounds and is highly selective for residual solvents making it a great choice for USP<467>. These columns are manufactured for column-to-column reproducibility, so they are well suited for validated methods.

Features

- Temperature Range: -20 °C to 300/320 °C
- Similar to USP G43 phase
- Ideal choice for USP method 467

Applications

- Residual solvents
- Suitable for USP 467

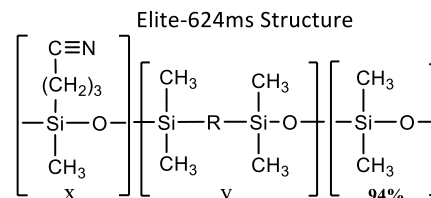

ID (mm)	df (μm)	Temp Limits (°C)	20 m Part No.	30 m Part No.	60 m Part No.
0.18	1.00	-20 to 300/320	N9315067		
0.25	1.40	-20 to 300/320		N9315068	N9315066
0.32	1.80	-20 to 300/320		N9315069	N9315070

Industrial

Determination of nine carbonates in lithium ion battery electrolyte by GC/MS.

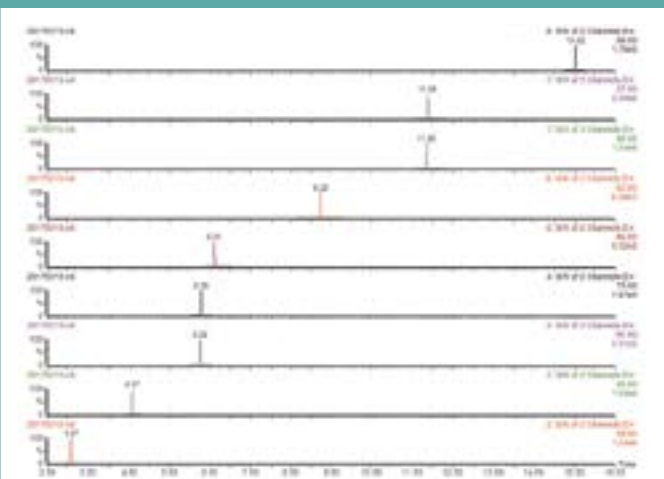

Recommended Column: Elite-35ms, 30 m x 0.25 mm x 0.25 μm (Part No. **N9316438**)

Liner: Capillary splitless deactivated glass liners with deactivated wool (**N9306235**)

High Temperature Columns

Available in a range of phases with varying polarity, the high temperature (ht) columns are specifically designed for reduced bleed when operating at higher temperatures, up to 400 °C. The optimum higher operating temperatures varies by phase.

Elite-1ht

ID (mm)	df (µm)	Temp Limits (°C)	15 m Part No.	30 m Part No.
0.25	0.10	-60 to 380/400	N9316268	N9316269
0.32	0.10	-60 to 380/400	N9316270	N9316271

Elite-17ht

ID (mm)	df (µm)	Temp Limits (°C)	30 m Part No.
0.25	0.15	40 to 300/320	N9316264
0.32	0.15	40 to 300/320	N9316266

Elite-5ht

ID (mm)	df (µm)	Temp Limits (°C)	15 m Part No.	30 m Part No.
0.25	0.10	-60 to 400	N9316272	N9316273
0.32	0.10	-60 to 400	N9316274	N9316275

Elite-SimDist ht

Application: High-temperature simulated distillation

Phase: Metal Column, 100% dimethylpolysiloxane, non-polar

ID (mm)	df (µm)	Temp Limits (°C)	5 m Part No.	6 m Part No.
0.53	0.15	-60 to 400		N6107191
0.53	0.10	-60 to 450	NR213314	

Metal High Temperature Columns

Using our new metal capillary columns eliminates the risk of column breakage at higher operating temperatures. A range of phases are offered, covering common applications. Rugged up to 450 °C although the exact upper temperature limits varies depending on phase and column configurations.

	Temp Limits (°C)	Inner Diameter (mm)	df (µm)	15 m Part No.	30 m Part No.	60 m Part No.
Elite-1mht	-60 to 340/430	0.25	0.1		N9303453	
Elite-1mht	-60 to 340/430	0.25	0.25	N9303454	N9303455	N9303456
Elite-5mht	-60 to 330/430	0.25	0.1	N9303457	N9303458	
Elite-5mht	-60 to 330/430	0.25	0.25	N9303459	N9303460	N9303461
Elite-1301mht	-20 to 280	0.53	3.0	N9303462	N9303463	
Elite-1701mht	-20 to 260	0.53	1.0	N9303464	N9303465	
Elite-1701mht	-20 to 250	0.53	1.5		N9303466	

Elite-BAC Advantage: Blood Alcohol Content

The Elite-BAC Advantage columns are optimized for selectivities guaranteed to resolve ethanol, internal standards, and frequently encountered interferences. These application-specific columns for blood alcohol analysis baseline separate all critical compounds, including ethanol, methanol, acetone, *tert*-butanol, acetaldehyde, isopropanol, and *n*-propanol, in less than 2 minutes. Every Elite-BAC 1 Advantage and Elite-BAC 2 Advantage column is qualified with a test mix containing these important BAC target compounds to ensure reproducibility. These columns, baseline separate all blood alcohol compounds in blood, breath, or urine, in less than 2 minutes, under isothermal conditions. Isothermal analysis increases productivity by eliminating the need for oven cycling. Confirmation is easily achieved with this tandem set because there are two elution order changes between the columns.

Features and Benefits

- Robust and reproducible
- Baseline separation of all components in less than 2 minutes
- Stable to 260 °C

Clinical

Elite-BAC 1 advantage.

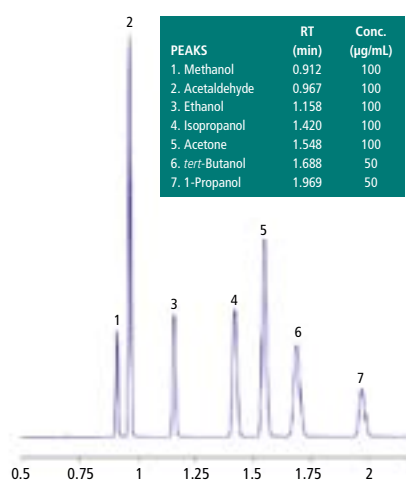

Clinical

Elite-BAC 2 advantage.

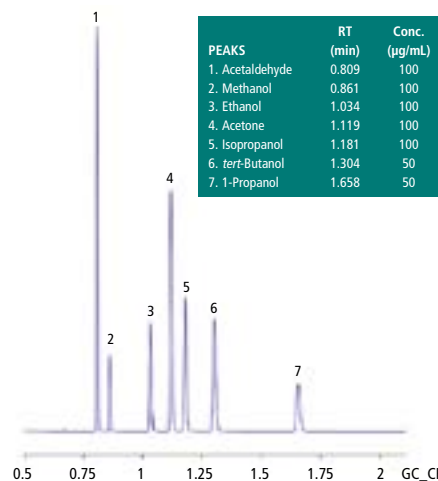

- Baseline resolution
- Symmetrical peaks
- Run time under 2 min

Column Type	ID (mm)	df (µm)	Temp Limits (°C)	10 m Part No.	30 m Part No.
Elite-BAC 1 Advantage	0.18	1.00	-20 to 240/260	N9315075	
	0.32	1.80	-20 to 240/260		N9315071
	0.53	3.00	-20 to 240/260		N9315072
Elite-BAC 2 Advantage	0.18	0.34	-20 to 240/260	N9315076	
	0.32	0.60	-20 to 240/260		N9315073
	0.53	1.00	-20 to 240/260		N9315074

Elite-VMS

Elite-VMS columns offer lower bleed, better selectivity, and overall faster analysis for separating volatile organic compounds. The stationary phase is a highly stable polymer that provides outstanding analysis of volatile compounds on MS detectors. The 0.18 and 0.25 mm ID columns allow sample splitting at the injection port, eliminating the added expense and maintenance of a jet separator. A 0.45 mm or 0.53 mm ID column can be directly connected to the purge-and-trap transfer line in a system equipped with a jet separator.

ID (mm)	df (µm)	Temp Limits (°C)	30 m Part No.	60 m Part No.
0.18	1.00	-40 to 240/260	N9316650¹	N9316651¹
0.25	1.40	-40 to 240/260	N9316652	N9316653
0.32	1.80	-40 to 240/260	N9316654	N9316655
0.45	2.55	-40 to 240/260	N9316656	N9316657
0.53	3.00	-40 to 240/260	N9316658	N9316659

¹ The lengths of N9316650 and N9316651 are 20 m and 40 m, respectively

Features and Benefits

- Temperature Range: -40 °C to 240/260 °C
- No known equivalent phases

Applications

- Ideal for analysis of volatile organic pollutants by GC/MS
- Suitable for EPA Method 8260B

Elite-XLB

The Elite-XLB phase is a proprietary low-polarity, very inert and exceptionally low bleed column for GC/MS analysis of pesticides, PCB congeners (e.g., Aroclor mixes) and PAHs. Improvements in polymer synthesis and tubing deactivation enable us to make inert, stable Elite-XLB columns especially well-suited for analyzing active, high molecular weight compounds with sensitive GC-MS systems, including ion trap detectors.

Features and Benefits

- Temperature Range: 30 °C to 340/360 °C
- No known equivalent phases
- Exceptionally low bleed for GC/MS

Applications

- Pesticides, PCB congeners
- Semi volatiles in drinking water
- Suitable for EPA Method 525

ID (mm)	df (µm)	Temp Limits (°C)	15 m Part No.	30 m Part No.	60 m Part No.
0.18	0.18	40 to 340/360		N9316480¹	
0.20	0.33	40 to 340/360	N9316496²	N9316497²	
0.25	0.10	40 to 340/360		N9316483	
	0.25	40 to 340/360	N9316481	N9316484	N9316487
	1.00	40 to 340/360	N9318482	N9316485	
0.32	0.10	40 to 340/360		N9316489	
	0.25	40 to 340/360	N9316488	N9316490	N9316493
	0.50	40 to 340/360		N9316492	
	1.00	40 to 340/360		N9316491	
0.53	1.50	40 to 320/340	N9316494	N9316495	

¹ The length of N9316480 is 20 m.

² The lengths of N9316496 and N9316497 are 12 m and 25 m, respectively.

Elite-Volatiles

The Elite-Volatiles stationary phase and optimized column dimensions provide low bleed, excellent resolution, and fast analysis times for volatile organic pollutants.

Features

- Temperature Range: -20 °C to 240 °C
- Proprietary phase
- Ideal for EPA Method 8021

Applications

- Volatile organic pollutants
- Suitable for EPA Method 8021

ID (mm)	df (µm)	Temp Limits (°C)	30 m Part No.	60 m Part No.	75 m Part No.
0.25	1.40	-20 to 240	N9316388	N9316389	
0.32	1.80	-20 to 240	N9316390	N9316391	
0.45	2.55	-20 to 240	N9316392		N9316393

Elite-CLPesticides: Chlorinated Pesticides

Elite-CLPesticides is specially designed to overcome the coelutions and analyte breakdown typically encountered in chlorinated pesticide analytes for U.S. EPA methods 8081, 608, and CLP. Column bleed measured by ECD is extremely low at temperatures greater than 300 °C, which is critical for baking out the column to remove high-boiling compounds commonly found in pesticide/PCB extracts.

Features and Benefits

- Thermally stable to 340 °C
- Low column bleed – ideal for ECD or GC/MS analysis
- Exceeds performance criteria for U.S. EPA Methods 8081, 608 and CLP
- Baseline separation in less than 15 minutes

Applications

- Chlorinated pesticides and herbicides
- Exceeds performance criteria for U.S. EPA Methods 8081, 608 and CLP

Column Type	ID (mm)	df (µm)	Temp Limits (°C)	15 m Part No.	30 m Part No.
Elite-CLPesticides	0.25	0.25	-60 to 320/340	N9316661	N9316662
	0.32	0.50	-60 to 320/340	N9316663	N9316664
	0.53	0.50	-60 to 300/320	N9316665	N9316666
Elite-CLPesticides 2	0.25	0.20	-20 to 240/260	N9316667	N9316668
	0.32	0.25	-20 to 240/260	N9316669	N9316670
	0.53	0.42	-20 to 240/260	N9316671	N9316672

Elite-502.2: U.S. EPA Method 502.2

Application: Analysis of volatiles by U.S. EPA method 502.2

Phase: Proprietary Dimethyl-diphenyl polysiloxane, low-polarity

ID (mm)	df (μm)	Temp Limits (°C)	60 m Part No.	75 m Part No.	105 m Part No.
0.25	1.40	0 to 250/270	N9316498		
0.45	2.55	0 to 250/270		N9316188	N9316189
0.53	3.00	0 to 250/270			N9316190

Elite-RX: Drugs of Abuse

Application: Analysis of drugs of abuse

Phase	ID (mm)	df (μm)	Temp Limits (°C)	12 m Part No.	25 m Part No.
Elite-1 RX	0.20	0.33	-60 to 330/350	N9316345	N9316346
Elite-5ms RX	0.20	0.33	-60 to 330/350	N9316349	N9316350
Elite-17 RX	0.20	0.33	40 to 300/320	N9316347	N9316348

Elite-Betacylodextrin: Chiral Separations

Application: General-purpose chiral, Chiral compounds in essential oils

Column Type	ID (mm)	df (μm)	Temp Limits (°C)	30 m Part No.
Elite-Betacydex	0.25	0.25	40 to 230	N9316319
Elite-Cyclosil B	0.25	0.25	40 to 230	N9316545

Elite-608

Application: Analysis of semivolatile pesticides by U.S. EPA method 608

Phase: Phenyl methyl polysiloxane, mid-polarity

ID (mm)	df (μm)	Temp Limits (°C)	15 m Part No.	30 m Part No.
0.32	0.50	40 to 290/310		N9316191
0.45	0.42	40 to 270/290	N9316194	N9316195
	0.70	40 to 260/280	N9316192	N9316193
0.53	0.50	40 to 270/290	N9316198	N9316199
	0.83	40 to 260/280	N9316196	N9316197

Elite-SimDist

Application: Simulated distillation

Phase: Specially processed dimethylpolysiloxane, non-polar

ID (mm)	df (μm)	Temp Limits (°C)	10 m Part No.
0.45	2.55	-60 to 360	N9316261
0.53	3.00	-60 to 360	N9316262

Elite-TPH

Application: Analysis of total petroleum hydrocarbons

Phase: (5%-diphenyl)-dimethylpolysiloxane, low polarity

ID (mm)	df (µm)	Temp Limits (°C)	30 m Part No.
0.32	0.25	-10 to 320	N9316386
0.45	1.00	-10 to 290	N9316387

Elite-PONA

Application: Detailed analysis of petroleum naphtha

Phase: Specially processed dimethylpolysiloxane, non-polar

ID (mm)	df (µm)	Temp Limits (°C)	50 m Part No.	100 m Part No.
0.20	0.50	-60 to 300/320	N9316065	
0.25	0.50	-60 to 300/320		N9316015

Elite-FFAP

Application: Free fatty acids

Phase: Nitroterephthalic acid modified PEG (bonded), polar

ID (mm)	df (µm)	Temp Limits (°C)	15 m Part No.	30 m Part No.
0.25	0.25	40 to 250	N9316351	N9316352
0.32	0.25	40 to 250	N9316353	N9316354
0.45	0.85	40 to 240/250	N9316355	N9316356
0.53	1.00	40 to 240/250	N9316357	N9316358

Elite-5 Amine

Application: Amines and other basic compounds including alkylamines and di/triamines

ID (mm)	df (µm)	Temp Limits (°C)	15 m Part No.	30 m Part No.
0.25	0.50	-60 to 300/315	N9316684	N9316673
	1.00	-60 to 300/315	N9316674	N9316675
0.32	1.00	-60 to 300/315	N9316676	N9316677
	1.50	-60 to 290/305	N9316678	N9316679
0.53	1.00	-60 to 290/305		N9316680
	3.00	-60 to 280/295	N9316681	N9316682

Elite-2330/Elite-23

Application: Analysis of cis/trans isomers in FAMES and dioxin isomers. Equivalent to USP G8 and G48

Phase: Biscyanopropyl cyanopropylphenyl polysiloxane, highly polar

ID (mm)	df (µm)	Temp Limits (°C)	60 m Part No.	Column Type
0.25	0.10	0 to 275	N6107813	Elite-2330
0.25	0.20	0 to 275	N6107814	Elite-2330
0.25	0.25	40 to 250/260	N9316508	Elite-23

Elite-MTBE

Application: Analysis of methyl t-butylether and other oxygenates

Phase: Proprietary low polarity phase

ID (mm)	df (µm)	Temp Limits (°C)	30 m Part No.
0.45	2.55	10 to 250	N9316520
0.53	3.00	10 to 250	N9316521

Elite-2560

Application: Application-specific column for cis/trans FAMES

Phase: Biscyanopropylpolysiloxane, highly polar

ID (mm)	df (µm)	Temp Limits (°C)	100 m Part No.
0.25	0.20	20 to 250	N9311570

Elite-Carbon Columns

For Volatiles in Hydrocarbon Streams

The Elite-Carbon columns offer rapid separation of permanent gas/light hydrocarbon mixtures; including carbon monoxide and carbon dioxide without cryogenic cooling. They are preconditioned and thus take less than 30 minutes to stabilize. They are used in conjunction with a molecular sieve column (Molecular sieve 5 Å, 50 m, 0.53 mm, 50 µm Part No. **NR201108**).

ID (mm)	Length (m)	Mesh Size	Temp Limits (°C)	Part No.
1.0	1	100/120	Up to 300	N9303927
1.0	2	100/120	Up to 300	N9303926

Fittings for the micropacked Elite-Carbon columns need to be ordered separately.

Description	Part No.
Installation kit for 1 mm ID columns; for valve applications	N9303450
Installation kit for 1 mm ID columns; for direct injections	N9303451

Elite-Alumina/KCl* PLOT

ID (mm)	Length (m)	Film Thickness (μm)	Temp Limits (°C)	Part No.
0.53	50	10	up to 200	N9316544

* Lower Polarity than Elite-Alumina.

Elite-Alumina/Na₂SO₄ PLOT

ID (mm)	Length (m)	Film Thickness (μm)	Temp Limits (°C)	Part No.
0.32	50	5	up to 200	N6107777

Elite-Alumina PLOT

Phase for Analysis of Light Hydrocarbons

ID (mm)	Length (m)	Film Thickness (μm)	Temp Limits (°C)	Part No.
0.53	30	6	-60 to 200	N9316304
0.53	50	10	-60 to 200	N9316305

Note: -60 °C is the lowest temperature used on this phase in our lab. Lower temperatures may be used depending on the sample.

Elite-Cyclosil B PLOT

For Chiral Separations

ID (mm)	Length (m)	Film Thickness (μm)	Temp Limits (°C)	Part No.
0.25	30	0.25	35 to 230	N9316545
0.32	30	0.25	35 to 230	N9316546

Elite-Molesieve PLOT

Phase for Analysis of Permanent Gases

ID (mm)	Length (m)	Film Thickness (μm)	Temp Limits (°C)	Part No.
0.53	30	—	-60 to 300	N9316361

Note: -60 °C is the lowest temperature used on this phase in our lab. Lower temperatures may be used depending on the sample.

Elite-Q PLOT

Phase for Analysis of Light Gases and Hydrocarbons

ID (mm)	Length (m)	Film Thickness (μm)	Temp Limits (°C)	Part No.
0.32	30	10	-60 to 250	N9316359
0.53	30	20	-60 to 250	N9316360

Note: -60 °C is the lowest temperature used on this phase in our lab. Lower temperatures may be used depending on the sample.

Miscellaneous Accessories

Description	Part No.
2 oz. Replacement Charcoal (30/60 mesh)	03300904
Liner Removal Tool	N6100102
Injector/Detector Adapter 1/4 in. Adapter fits on injector and detector outlet (inside oven) for use with 1/4 in. columns	00080100
Silanized Glass Wool (2 oz.)	03300905

Wide-Bore Adapter Kit

Contains all the parts necessary to adapt to packed column injectors quickly and easily for use with wide-bore capillary columns. Includes 0–20 mL/min flow controller element, wide-bore adapter with 1/16 in. fitting, wide-bore glass liner and column support hanger.

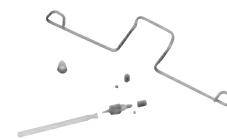

Description	Part No.
0.53 Capillary Column Adapter Kit	N6120001

Wafer Scribes

The PerkinElmer ceramic wafer scribe is inexpensive and ideal for cutting polyimide fused silica capillary columns and guard columns. The scribe is easy to hold and simple to use. All four sides can be used as a cutting tool.



Description	Part No.
Wafer Scribes (pkg. 10)	N9301376

Connectors

Universal Connectors



Description	Part No.
Deactivated Presstight Column Connectors (pkg. 5)	N9302149
Metal Universal Connectors: 0.25 mm ID (pkg. 10)	N9301167
Deactivated Y Splitter Presstight Column Connectors (pkg. 3)	N9306380
Polyimide Sealing Resin (5 g)	N9301343

GC Consumables & Accessories

PerkinElmer offers a wide selection of superior quality products designed to work with your PerkinElmer instruments. Our precision designed products deliver the peace of mind that comes from knowing that you'll get the results you need.

Quick Reference Index

	Page
▶ Catalytic Reactor Accessory	108
▶ Clarus 480/580/680 Consumables	101
▶ Clarus 480/580/680 FID Add-On Kits	102
▶ Clarus 590/690 Consumables	105
▶ Detector Series Operation Kit	107
▶ ECD Add-On Kits, ECD Wipe Test Kits	116
▶ Ferrules	96
▶ FPD Spares for All Clarus GC Models	114
▶ Inlet Liners for Clarus 480, 580, 680	93
▶ Inlet Liners for Clarus 590, 690	94
▶ Inlet Septa	91-92
▶ Marathon Filament	98
▶ Merlin MicroSeal Septum	101
▶ NPD Spares for All Clarus GC Models	117
▶ Packed Column Injector for All Clarus GC Models	111
▶ PID Spares for All Clarus GC Models	118
▶ PSS Injector Liners for All Clarus GC Systems	95
▶ POC Spares for All Clarus GC Models	113
▶ PSS Spares for All Clarus GC Models	112
▶ SMARTsource	99-100
▶ Swafer	108-109
▶ Swagelok Fittings	119
▶ Syringes	97
▶ TCD Spares for All Clarus GC Models	115
▶ TCD/FID Series Operation Kit	115
▶ TurboMatrix 40 Headspace Trap	110
▶ Wide Range FID Add-On Kits	107
▶ Wide Range FID Miscellaneous Accessories	107

GC Inlet Septa

We offer a range of inert septa, suited to different application needs. The blue septa offer a high-performance cost-effective alternative, offering a good level of inertness and are recommended for GC applications.



▶ [VIEW PAGE](#)

Marathon Filament

The marathon filament has been engineered to provide exceptional long life and withstand difficult chromatography conditions.



▶ [VIEW PAGE](#)

Ferrules

Graphite and Graphite/Vespel ferrules in different configuration are available. The choice of which depends on your application or use within the GC instrument.



▶ [VIEW PAGE](#)

Syringes

Syringes from PerkinElmer are individually inspected for accuracy and performance. For routine analyzes, the metal plunger in barrel with PTFE-tipped seal is the standard syringe as shipped with each Clarus GC instrument.

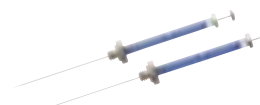

▶ [VIEW PAGE](#)



BETTER GC FOR THE MOST CRITICAL APPLICATIONS – YOURS

Superior sensitivity, capacity, and throughput – with flexibility to handle more applications

Our new Clarus® 590 and 690 systems are making GC more productive, more consistent – and more flexible than ever. Productive, because our proprietary autosampler technology, superfast oven cool-down, and programmable temperature injectors make it much more efficient. Consistent, because it delivers precise, repeatable sample introduction and fewer reruns. And flexible, because we integrate best-in-class TurboMatrix® headspace, thermal desorption, and hands-free liquid or SPME sample prep. Highly capable Clarus systems are simply better for the most important applications of all – those most important to you.

Learn more at perkinelmer.com



GC Inlet Septa



Injector septa used in Gas Chromatography provide a critical role in maintaining system isolation but allowing the sample to be introduced onto the column in a Quantative manor. Since the injector septa provide the seal between the inner workings of the injector and the laboratory environment, it must have several desirable characteristics. For best performance the septa should be inert, low off-gassing of silicone oligomers, soft enough to avoid bending the needle and reseal after injection and resistant to coring by the syringe.

We offer a range of inert septa, suited to different application needs. The BTO (orange) septa offer the ultimate in inertness and are ideally suited to GC/MS applications and trace analysis. The mid-range advanced green septa combine low inlet adhesion properties with long lifetime and are recommended for GC applications. The blue septa offer a high-performance cost-effective alternative, offering a good level of inertness and are also recommended for GC applications.

Features and Benefits

- Select from a range of GC septa with varying properties limits
- Non-stick coating ensures no adhesion of the septa to the GC inlet
- Pre-conditioned septa, ready to use
- The CenterGuide design facilitates needle penetration to the same point with every injection, for easy and rugged operation
- Pre-pierced BTO septa provide long autosampler injection life
- Stay clean surface does not attract dust
- Compatible with all GC instruments

BTO (Orange)

Septa rated to 400 °C. The precision molded silicone rubber septa BTO® (Bleed Temperature Optimized) are premium ultra-low bleed injector septa for today's most demanding applications. The BTO septa are uniquely formulated to extend ultra-low bleed characteristics and outstanding mechanical properties. It retains remarkable softness, even at high temperatures, and has been optimized to reduce injection port adhesion, with the addition of a non-stick coating. The pre-pierced BTO septa also benefit from the CenterGuide design. They have a recess on the injection side to help guide the syringe needle to the same point for every injection. The BTO septa are recommended for GC/MS applications.

Green

Septa rated to 350 °C. The advanced green septa were created to combine significantly longer injection life, low bleed and low injection port adhesion. These septa also benefit from also with the non-stick coating and the CenterGuide design. The result is a mid-range general purpose septum made of uniquely formulated silicone rubber you can use for all your daily analyzes.

Blue

Septa rated to 275 °C. The blue septa are designed for routine applications. Employing a soft silicone rubber material and stay clean surface, they are easy to penetrate without a recess. As the blue septa used at lower operating temperatures the non-stick coating is not required to prevent inlet adhesion. They offer a low level of inertness and for routine GC applications providing optimum performance at lower operating temperatures.

Comparison of septa bleed by TD-GC/MS.

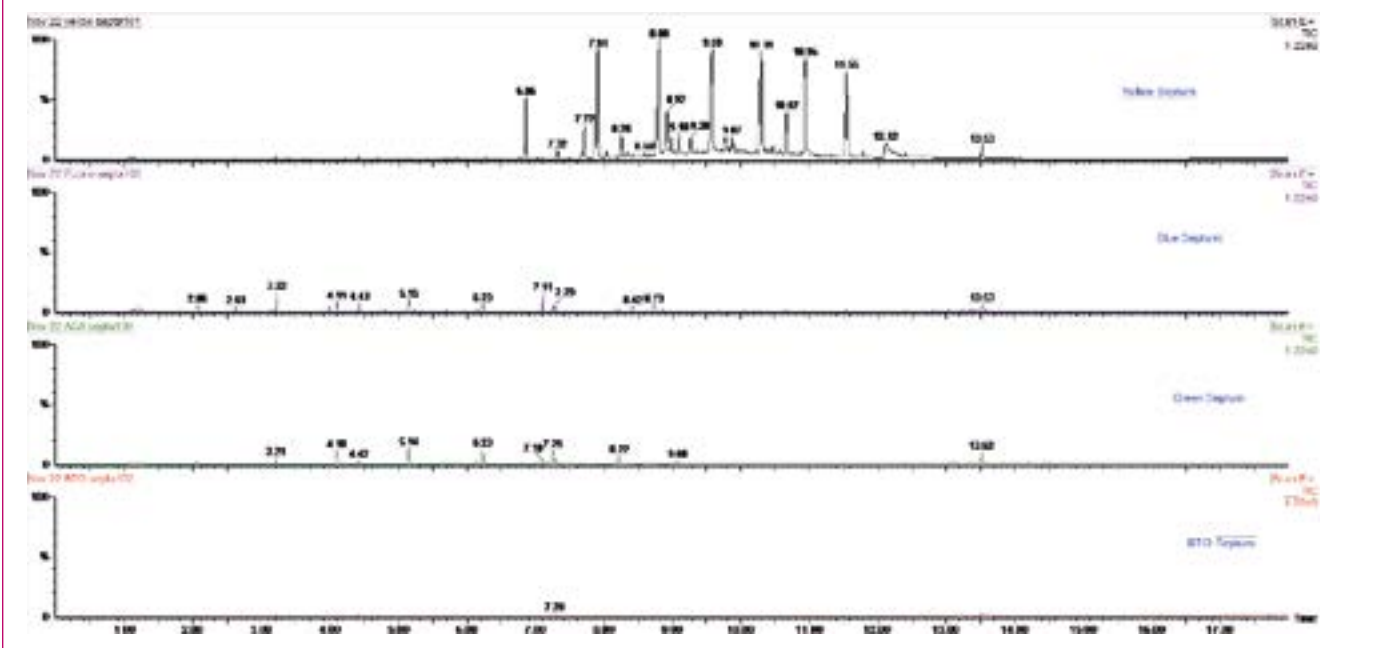

Septa come packed in a glass jar, for high purity. Or select the disc format where septa are located in individual pockets for ease of selection and avoids any risk of cross contamination.







Description	Quantity	Part No.
BTO Orange Injection Port Septa	50	N9302972
BTO Orange Injection Port Septa	10	N9306872
Green Injection Port Septa	50	N9306219
Green Injection Port Septa	10	N9306218
Blue Injection Port Septa	50	N9306874
Blue Injection Port Septa	10	N9306873

Clarus 480, 580, 680 GC Capillary Inlet Liners

Inlet liners for split injection have mixing chambers with tortuous flow paths to allow full vaporization of the sample. Deactivating the surface of these liners prevents active compounds from degrading. Packing the liner with wool will trap non-volatile residue and prevent column contamination when analyzing dirty samples.

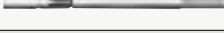
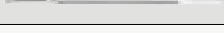
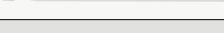

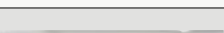
Inlet liners for splitless injection are generally designed as straight tubes, although new designs such as the gooseneck will help contain the sample in the injector. Packing these liners with wool will also help trap non-volatile residue and prevent column contamination.

Split Injector Liners*

Product	Description	ID (mm)	OD (mm)	Length (mm)	Pkg.	Part No.
	Split Glass Liner Ultra Deactivated Surface Liner (with wool) – Universal liner for general purpose analysis	4	6.2	92.1	5	N6121020
	Split Glass Liner (with wool) – Universal liner for general purpose analyzes	4	6.2	92.1	5	N6502009
	Split Siltek Deactivated Glass Liner (with wool) – Universal liner for general purpose analyzes	4	6.2	92.1	5	N6502010
	Clarus Cup Split Glass Liner – Good for both high and low molecular weight compounds	4	6.2	92.1	5	N6502011
	Uniliner Deactivated Glass Liner (with wool) – Universal liner for general purpose analyzes	4	6.2	92.1	5	N6121022
	Zero Dilution Glass Outer Liner – Ideal for trace HS work. Use in conjunction with N1011446	2	6.3	90	1	N1011445
	Zero Dilution Glass Inner Liner – Ideal for trace HS work. Use in conjunction with N1011445		2	73	1	N1011446
	Quartz Liner for Split Operation – Good for large volume injection samples	4	6.2	92.1	1	N6121001
	Glass Liner for Split Operation – Universal liner for general purpose analyzes	4	6.2	92.1	1	N6101052

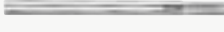
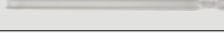
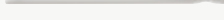

* Not compatible with Clarus 590/690 capillary injector.

Splitless Injector Liners*

Product	Description	ID (mm)	OD (mm)	Length (mm)	Pkg.	Part No.
	Clarus Splitless Glass Liner – Low volume sample analyzes, beneficial with headspace and purge/trap	1	6.2	92.1	5	N6502006
	Quartz Liner for Splitless Operation (ships with instrument) – Standard injector liner	2	6.2	92.1	1	N6121002
	Glass Liner for Splitless Operation – Universal liner for general purpose analyzes	2	6.2	92.1	1	N6101372
	Deactivated Glass Liner for Splitless Operation (with wool) – Good for analyzes of trace samples	2	6.2	92.1	5	N6121021
	Wide-Bore Column Glass Liner (for 0.53 mm ID columns)	4	6	92.1	1	N6101375
	Wide-Bore Column On/Off Quartz Liner (for 0.53 mm ID columns)	4	6	92.1	1	N6121003

* Not compatible with Clarus 590/690 capillary injector.

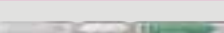
Split/Splitless Injector Liners*



Product	Description	ID (mm)	OD (mm)	Length (mm)	Pkg.	Part No.
	Capillary Split/Splitless Deactivated Glass Liners with Deactivated Wool	4	6.2	92.1	5	N9306233
	Capillary Split/Splitless Deactivated Glass Liners with Deactivated Wool and Tapered End	4	6.2	92.1	5	N9306235
	Capillary Split/Splitless Deactivated Glass Liners with deactivated Wool. Quartz wool is used to fully vaporize the sample	4	6.2	92.1	5	N9306236

* Not compatible with Clarus 690/590 GC capillary injector.



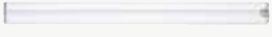
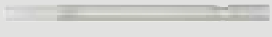

Clarus 590, 690 Capillary GC Inlet Liners

For the capillary injector on the Clarus 590 or 690 GC system, the liners are required to be 78.5 mm long. These liners are not compatible with the older Clarus GC systems (480, 580, 680 and any prior models).



Split Injector Liners

Product	Description	ID (mm)	OD (mm)	Length (mm)	Pkg.	Part No.
	Ultra-deactivated Split Precision Liner with Wool	4	6.3	78.5	5	N6502034
	Ultra Deactivated Straight Inlet Liner, no Wool (for P&T, HS, Gas Sampling)	1	6.3	78.5	5	N6502037
	Quartz Glass Liner, no Wool, Straight Through with Dimple at the Bottom	4	6.3	78.5	1	N6502038
	Straight Through Glass Liner, no Wool	2	6.3	78.5	1	N6502039
	Glass Liner, Straight Through with Dimple at Bottom, no Wool	4	6.3	78.5	1	N6502040
	Ultra-Deactivated 0.75 mm ID Straight/SPME Inlet Liner	0.75	6.3	78.5	5	N6502044
	Ultra Deactivated Single Low Pressure Drop Precision Liner with Wool	4	6.3	78.5	5	N6502032
	Ultra Deactivated Straight Inlet Liner with Wool for Split/Splitless Inlets	4	6.3	78.5	5	N6502036

Splitless Injector Liners











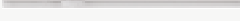

Product	Description	ID (mm)	OD (mm)	Length (mm)	Pkg.	Part No.
	Ultra Deactivated Glass Liner Single Taper for Splitless Injection	2	6.5	78.5	5	N6502030
	Ultra Deactivated Single Taper Splitless Liner	4	6.5	78.5	5	N6502031
	Ultra Deactivated Single Taper Inlet Liner with Wool for Splitless Inlets	4	6.5	78.5	5	N6502035
	Ultra Deactivated Straight Splitless Liner with Wool	2	6.5	78.5	5	N6502033

Split/Splitless Injector Liners

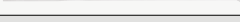
Product	Description	ID (mm)	OD (mm)	Length (mm)	Pkg.	Part No.
	Capillary Split/Splitless Deactivated Glass Liners with Deactivated Wool	4	6.3	78.5	5	N6502041
	Capillary Split/Splitless Deactivated Glass Liners with Deactivated Wool and Tapered End	4	6.3	78.5	5	N6502042

PSS Injector Liners for all Clarus GC Systems

Programmed Temperature Split/Splitless (PSS) Injector Liners

Product	Description	ID (mm)	OD (mm)	Length (mm)	Pkg.	Part No.
	PSS Deactivated Glass Injector Liner for Split Operation – specifically designed to be used for Fuel in Oil analysis, loosely packed with deactivated wool	2	4	86.2	5	N9302949
	Siltek Deactivated Glass PSS Splitless Liner – Used for low volume trace sample analysis	1	4	86.2	5	N6502000
	Quartz Liner for Splitless Operation – Excellent liner for low volume analyzes	1	4	86.2	1	N6121006
	Quartz Liner for Split Operation – Standard injector liner for routine applications	2	4	86.2	1	N6121004
	Siltek Deactivated Glass Liner for Split Operation (with wool) – Maximum inertness and packed with wool gives optimum sample dispersion. Surface provides inertness over wide sample pH range. Wool can be adsorptive if fibers are broken	2	4	86.2	5	N6502001
	Siltek Deactivated Glass Liner for Split Operation – Max inertness gives optimum sample dispersion. Deactivated surface provides minimal bleed and inertness over a wide sample pH range	2	4	86.2	5	N6502002
	Zero Dilution Outer Liner – Use in conjunction with N1011446	2.8	4	83	1	N1011447
	Zero Dilution Inner Liner – Use in conjunction with N1011447		2	73	1	N1011446
	On-column Glass Liner	2.4	4	86.2	1	N6101539
	Liner/Hour Glass for POC Injector	2.4	4	19.05	1	N6101703
	Quartz Split Liner with Silanized Glass Wool	2	4	86.2	1	N6121008
	Quartz Split Liner with Silanized Glass Wool	2	4	86.2	5	N6121009
	Deactivated Glass Liners with Deactivated Wool. Narrow bore and quartz wool increase volatilization and reproducibility	2	4	86.2	5	N9306232
	Splitless Deactivated Glass Liners	1.25	4	86.2	5	N9306237

Packed Column Injector liners for all Clarus GC Models

Packed Column Injector Liners

Description	ID (mm)	OD (mm)	Length (mm)	Pkg.	Part No.
Glass Liner	3	6	112	1	N6101048
Quartz Liner	3	6	112	1	N6121000

Ferrules

Capillary Column Ferrules*

Different materials and configurations of ferrules are available, the choice of which depends on your application or use within the GC instrument.

Column ID (mm)	Ferrule ID (mm)
≤ 0.25	0.4
0.32	0.5
0.53	0.8

Graphite

Ferrule of choice for high-temperature applications up to 450 °C. Graphite seals easily and does not stick to glass columns. Suitable for use with FID, TCD and ECD detectors.

Graphite/Vespel®

15% graphite/85% polyimide ferrules are recommended for use with GC/MS systems. The upper temperature limit is 400 °C.







Short Ferrules

For use with the new capillary injector design on the Clarus 590 and 690 systems. These short ferrules are not compatible with the older Clarus instruments.

Standard Ferrules

PerkinElmer standard ferrules are used in for connecting columns to the detectors on all GC models. They are suitable for use on the older Clarus capillary injectors (480, 580, 680 and prior instruments).

Short Ferrules for use with the Clarus 590/690 Capillary Injector

Size	For use with Column ID (mm)	Ferrule ID (mm)	Graphite Part No.	Graphite/Vespel Part No.
1/16 in.	≤0.25	0.4	09200785	09200685
				
1/16 in.	0.32	0.5**	09200785	09200686
				
1/16 in.	0.53	0.8	09200787	09200687
				
1/16 in.	0.32 (Two hole ferrule)	0.5	–	09200788

** Same graphite Part No. for 0.4 and 0.5 mm opening.

Standard Ferrules for use with the Clarus 480/580/680 Capillary Injector

Size	For use with Column ID (mm)	Ferrule ID (mm)	Graphite Part No.	Graphite/Vespel Part No.
1/16 in.	≤0.25	0.4	NEW N9307245	09920104
				
1/16 in.	0.32	0.5	09903700	09920105
				
1/16 in.	0.53	0.8	09920141	09920107
				
1/16 in.	0.32 (Two hole ferrule)	0.5	N9306001	N9306000
				
1/8 in.	0.32 (Two hole ferrule)	0.5	09903395	
				

Standard Ferrules for use with detectors – all Clarus models

Size	For use with Column ID (mm)	Ferrule ID (mm)	Graphite Part No.	Graphite/Vespel Part No.
1/16 in.	≤0.25	0.4	NEW N9307245	09920104
				
1/16 in.	0.32	0.5	09903700	09920105
				
1/16 in.	0.53	0.8	09920141	09920107
				
1/8 in.	0.53	1.0	09903394	
				
1/8 in.	≤0.32	0.5	09903981	

Autosampler and Manual Syringes

Point Style 2

This is a general purpose point style designed for septum penetration in all chromatographic techniques. The needle has a 22° bevel to minimize coring and needle plugging.



Point Style 3

Needle has a 90° bevel. This point style is recommended when the syringe is used for accurate pipetting of liquids. Excellent for mixing standards of very small volume.



GC Autosampler Syringes

Syringes from PerkinElmer are individually inspected for accuracy and performance.

Recommended autosampler syringes are available in 0.5, 5 and 50 µL capacities. For routine analyzes, the metal plunger in barrel with PTFE-tipped seal is the standard syringe as shipped with each Clarus® GC instrument. Alternative syringes to use are the metal plunger in barrel or the 0.53 mm on-column injection.

Description	Part No.
50 µL Syringe, Metal Plunger 0.63 mm OD Needle	N6101760
5 µL Syringe, Metal Plunger PTFE-tipped Seal 0.63 mm OD Needle (ships with instrument)	N6101390
5 µL Syringe, Metal Plunger PTFE-tipped Seal 0.63 mm OD Needle BLUE Barrel (pkg. 5 syringes)	N6103240
5 µL Syringe, Metal Plunger PTFE-tipped Seal 0.63 mm OD Needle BLUE Barrel (pkg. 10 syringes)	N6103241
5 µL Syringe, Metal Plunger 0.63 mm OD Needle	N6101251
0.5 µL Low Injection Volume Syringe, Metal Plunger 0.47 mm OD Needle	N6101253
5 µL On-column Syringe Metal Plunger 0.47 mm OD Needle	N6101380
5 µL, Syringe, PTFE-tipped Metal Plunger 0.47 mm OD Needle	N9308975
0.5 µL Low Injection Volume Syringe, Metal Plunger 0.63 mm OD Needle	N6101252
0.5 µL Low Injection Volume Syringe Metal Plunger 0.63 mm OD Needle BLUE Barrel (pkg. 5 syringes)	N6103242
0.5 µL Low Injection Volume Syringe Metal Plunger 0.63 mm OD Needle BLUE Barrel (pkg. 10 syringes)	N6103243



New Blue Barrel color design for enhanced sample volume verification (packs of 5 and 10 syringes)

Syringes – Gas Tight

Syringe Capacity	Fixed Needle (N) Part No.	Removable Needle (RN) Part No.
10 µL	N9302240	N9302241
25 µL	N9302242	N9302243
50 µL	N9302244	N9302245
100 µL	N9302247	
250 µL	N9302250	N9302251
500 µL	N9302253	N9302254
1.0 mL	N9302256	N9302257
2.5 mL	N9302259	
5.0 mL	N9302262	
10 mL	N9302265	N9302266

GC Manual Syringes

Features and Benefits

- All PerkinElmer injectors have been tested and optimized for use with a 7 cm needle
- A 7 cm needle is critical to be sure your sample is deposited in the optimal zone

Syringe Capacity	Gauge	Length	Pkg.	Point Style	Part No.
Removable Needle Syringes (RN)					
10 µL			1	#2	N9302210
25 µL			1	#2	N9302211
50 µL			1	#2	N9302212
100 µL			1	#2	N9302213
Replacement Needles for RN Syringes					
10 µL			1	#2	N9302222
25/50/100 µL	22S	2 in.	3	#2	N9302224
250 µL	22S	2 in.	3	#2	N9302226
Fixed Needle Syringes					
10 µL ³			1	#2	00230523
10 µL ²			5	#2	N9302287
25 µL			1	#2	N9302202
25 µL			1	#3	09904823
50 µL			1	#2	N9302203
50 µL			1	#3	09904941

² Savings based on one-piece price. Savings of 20% reflected in price shown.
³ Standard fitted with 7 cm needle.

Replacement Needle for Removable Needle Syringes (RN)

Syringe Capacity	Gauge	Length	Pkg.	Point Style	Part No.
10 µL*	26S	7 cm	3	#2	N9302220

*Manual syringe recommended for PerkinElmer Injectors.

Marathon Filament



The Marathon™ Filament is a revolutionary, patent-pending technology developed exclusively by PerkinElmer, delivering long life even under the most difficult chromatography conditions.

After lengthy performance testing and filament research, the new Marathon Filament has been engineered to provide exceptional long life and withstand difficult chromatography conditions.

It has high resistance to demanding injections such as Headspace or purge and trap and has stood up to challenging applications such as flame-retardant analysis.

The Marathon Filament is a direct replacement of the previous rhenium filament – no system changes required.



Features and Benefits

- Long life even under the most difficult chromatography conditions
- Unique white surface engineered for maximum durability and optimum performance
- Now included with all new Clarus® GC/MS systems
- Backward compatible with all units using rhenium filaments
- Works with both electron and chemical ionization sources

Description	Part No.
Marathon Filament for PerkinElmer GC/MS Systems	N6470012

SMARTsource with Marathon Filament for Clarus SQ 8 GC/MS Systems

Capable of both EI and CI ionization, the SMARTsource™ (Simplified Maintenance And Removal Technology) on the Clarus® SQ 8 GC/MS has been designed for ultimate simplicity, flexibility and productivity. Switching sources can be done in a matter of seconds by simply twisting and pulling – no tools required, no wires to disconnect. Cleaning the source is equally as easy and can be performed by the user. So even if you're running tough matrices, you won't be slowed down by time-consuming expensive source cleanings and replacements.

Fewer Parts, Greater Ease

With very few parts, the SMARTsource is exceptionally robust and easy to maintain. Each component is clearly marked for simple reassembly, and reconfiguring between EI and CI can even be performed in less than 3 minutes with a quick-conversion kit. Since the source is removed from the front of the Clarus SQ 8, the analyzing quadrupole is never exposed, minimizing the risk of contamination to ensure more reliable data.



Take the guesswork out of setting your column depth. Our Handle Assembly allows for precise alignment of the column within the SMARTsource every time.



Features and Benefits

- 12 parts make up EI source
- SMARTsource rebuilt in minutes
- Remove SMARTsource with the twist of a wrist
- Marathon filament has a long life even under the most difficult chromatography conditions and is engineered for maximum durability and optimum performance

Handle Assembly (Source Blank and Sight)

Description	Part No.
Handle Assembly (Source Blank and Sight)	N6480380
Replacement Protective Cover	N6482024

SMARTsource Maintenance Kits

Description	Part No.
SQ8 Maintenance Kit Tool kit needed to maintain source	N6480360
SQ8 Deluxe Polishing Kit (120 Volt) Kit for polishing cleanable source parts	N6480361
SQ8 Deluxe Polishing Kit (240 Volt)	N6480362

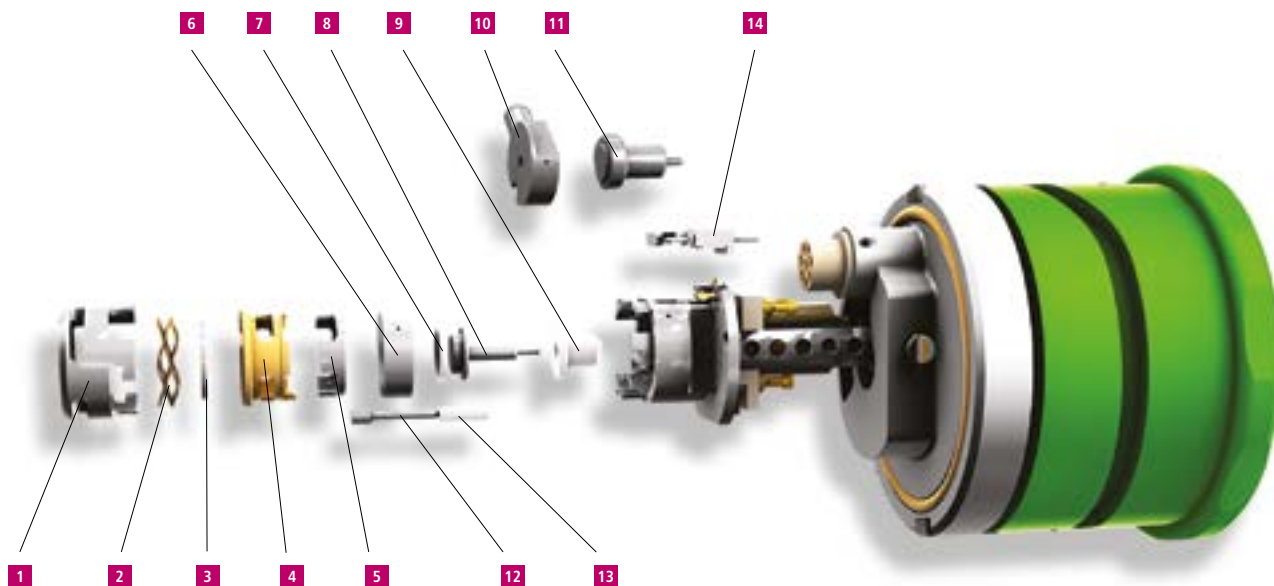

SMARTsource Replacement Parts

Description	Part No.
1 Source Lens #3	N6480149
2 Source Spring	N6480151
3 Source Lens #2	N6480148
4 Lens Insulator	N6480153
5 Source Lens #1	N6480147
6 El Ion Volume	N6480144
7 Insulator (Ion Volume)	N6480145
8 Repeller	N6480140
9 Insulator (Repeller)	N6480141
10 Cl Ion Volume	N6480146
11 Cl Ion Volume Disc	N6480154
12 Trap	N6480142
13 Insulator (Trap)	N6480143
14 Marathon Filament	N6470012

SMARTsource Kits

Description	Part No.
Complete EI Source Consists of a fully assembled EI Source, ready to install	N6480132
Complete CI Source Consists of a fully assembled CI Source, ready to install	N6480130
Insulator Replacement Kit (Numbers 2, 4, 7, 9, 13)	N6480080
El Optics Replacement Kit (Numbers 1, 3, 5, 6, 8, 12)	N6480081
Cl Optics Replacement Kit (Numbers 1, 3, 5, 8, 10, 12)	N6480082

Clarus 480/580/680 Consumables

With more than 50 years' experience in GC, the PerkinElmer family of Clarus® 480/580/680 GC instruments can be depended upon to meet the most demanding performance and throughput needs for today's analytical, process monitoring and quality control facilities.



Capillary Injector with PPC Kit

Kit includes split/splitless injector with programmable pneumatic control for carrier gas, split vent, heater, sensor, and heater block. The AutoSystem XL must be PPC™ ready. If not, a PPC upgrade kit (**N6120146**) is required. Installation by PerkinElmer Service is required, but not included. Not compatible with Clarus 590 and 690 models.

Voltage	Part No.
120 V	N6120138
230 V	N6120139

Complete Capillary Injector Add-On Kits

Kit includes split/splitless injector in module with heater and sensor, 0 – 60 psi pressure regulator, and transducer for pressure readout. For manual gas control. Not compatible with Clarus 590 and 690 models.

Voltage	Part No.
120 V Clarus	N6520012
230 V Clarus	N6520013

Dual Capillary Column Adapter Kit

Kit includes all necessary hardware to install two capillary columns to a capillary injector. Note: kit does not include appropriate 1/8 in. 2-hole ferrule (**N9306097**). For manual gas control. Not compatible with Clarus 590/690 capillary injector.

Voltage	Part No.
120 V	N6120050

Split/Splitless Injector Starter Kit

Includes: 2 mm ID quartz liner, 4 mm ID quartz liner, silicone O-rings (10), green septa (50), 0.5 mm graphite ferrules (10), 0.8 mm graphite ferrules (10), 1/16 in. stainless steel nuts (5), untreated quartz wool, packing rod, and wafer scribes (10). Not compatible with Clarus 590 and 690 models.

Description	Part No.
Split/Splitless Injector Starter Kit for Manual Gas Control	N6120101

Merlin MicroSeal Septum for 480/580/680 Systems

The Merlin MicroSeal™ septa is a unique replacement septa employing a two-step sealing system and an advanced elastomer material. It is ideally suited to SPME applications.



Because the syringe needle does not pierce the septa, there is no debris and ghost peaks are greatly reduced. The MicroSeal septa also reduces the incidence of bent syringe needles and liner contamination. Usable in either manual or autosampler applications, this septa can improve your productivity and run reliability. Designed to be used with 23 gauge straight needle syringes. Pressure ranges from 4 to 100 psi and injection port temperatures up to 325 °C. This is not compatible with Clarus 690/590 GCs.

Description	Part No.
Merlin MicroSeal Septum Kit Includes: Injector Port Adapter, 2 Septa and 1 Nut	N9303344
Merlin MicroSeal Septum	N9303345

Wide Range FID Add-On Kits

Auto-Ignite Wide Range FID Add-On Kit (with PPC)

Kit includes: detector assembly with heater and sensor, heater block, igniter, programmable pneumatics, amplifier and controls for detector combustion gases. GC must be PPC ready. If not, a PPC upgrade kit (**N6120146**) is required. Installation by PerkinElmer Service is required, but not included.

Voltage	Part No.
120 V	N6550167
230 V	N6550168

Clarus 480/580/680 FID Add-On Kits

Auto-Ignite FID with PPC Add-On Kit*

Kit includes: detector assembly with heater and sensor, heater block, igniter, programmable pneumatics, and controls for detector combustion gases. Requires, but does not include, amplifier (N6109364) and AutoSystem XL firmware revision 3.3 or higher. The AutoSystem XL must be PPC ready. If not, a PPC upgrade kit (N6120146) is required.

Voltage	Part No.
120 V*	N6120167
230 V*	N6120168

*Not compatible with the FID detector on the Clarus 690 and 590 GCs. Refer to the Clarus 590/690 consumables reference guide for more details.

Auto-Ignite FID Add-On Kit (Manual Pneumatics)

Kit includes: detector assembly with heater and sensor, heater block, igniter, hydrogen pressure regulator, and needle valve. Requires, but does not include, amplifier (N6109364). Requires AutoSystem XL to have firmware revision 3.3 or higher.

Voltage	Part No.
120 V Clarus*	N6520018
230 V Clarus*	N6520019

*Not compatible with the FID detector on the Clarus 690 and 590 GCs. Refer to the Clarus 590/690 consumables reference guide for more details.

FID Amplifier

Required for use with FID Detector Add-On Kit*.

Description	Part No.
FID Amplifier	N6109364

* This is not required for the Clarus 590/690 FID add-on kits.

Auto-Ignite FID Replacement Parts*

Description	Part No.
1 Collector Head Assembly Silicone Rubber O-ring* (not shown)	N6100357 09902143
2 Polarizer Nozzle	N6103167
3 Nozzle Insulator	09907827
4 Nozzle Collector	N6101085
5 Body Assembly	N6103175
6 FID Jet Contact/Spring	N6001204
7 Jet Assembly*	N6100361
8 FID Body	N6100364
9 Nozzle Assembly	N6100430

*Not compatible with the FID detector on the Clarus 690 and 590 GCs. Refer to the Clarus 590/690 consumables reference guide for more details.

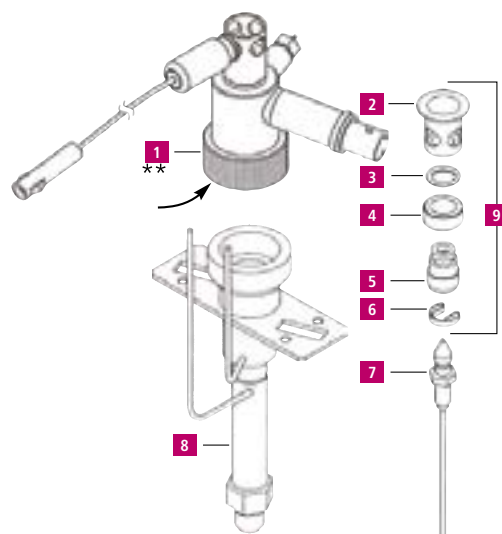

Detector Series Operation Kit

TCD/FID Series Operation Kit

Used to direct sample effluent from the TCD to the FID.

Description	Part No.
TCD/FID Series Operation Kit	N6120006

Clarus 480/580/680 FID Miscellaneous Accessories*

Description	Part No.
Auto-Ignite Nozzle Replacement Tool for removing nozzle from auto-ignite FID body	N6103188
Auto-Ignite FID Catalytic Reactor Accessory*	N6120161
Capillary Column Adapter for capillary column use with the FID 1/8 to 1/16 in. detector adapter	N6120020
Ceramic Column Cutter	N9301376
Detector Cover (White Color)	N6103151
Eraser Brush-Pencil	09923078
Jet Assembly*	N6100194
Jet Replacement Tool 1/4 in. nut driver for removing jet from auto-ignite FID body	N6101297
Replacement Stainless Steel Glow Plug for Auto-ignite FID	N6103089
Septa, low bleed (pkg. 50)	N9302972
1/4 in. Packed Column Adapter for use with 1/4 in. packed columns. 1/8 to 1/4 in. adapter fits both injector and detector ends	00080100

*Not compatible with the FID detector on the Clarus 690 and 590 GCs. Refer to the Clarus 590/690 consumables reference guide for more details.

Clarus 480/580/680 Catalytic Reactor Accessory

Auto-Ignite FID with PPC Add-On Kit

The catalytic reactor converts CO and CO₂ to methane conveniently and efficiently. The lower detection limit is extended to well below 0.1 ppm.

The catalytic reactor consists of a special catalytic reactor base which replaces the FID base. The reactor body contains a quantity of catalyst held in place by a quartz wool plug.

Kits include base assembly, reactor tube, and instructions.

External Igniter FID Catalytic Reactor Accessory

Description	Part No.
External Igniter FID Catalytic Reactor Accessory*	N6120070

Auto-Ignite FID Catalytic Reactor Accessory

Description	Part No.
Auto-Ignite FID Catalytic Reactor Accessory*	N6120161

*Not compatible with the FID detector on the Clarus 690 and 590 GCs. Refer to the Clarus 590/690 consumables reference guide for more details.

Catalytic Reactor Replacement Parts

Description	Part No.
Catalyst	N9302698
Jet Assembly	N6100194

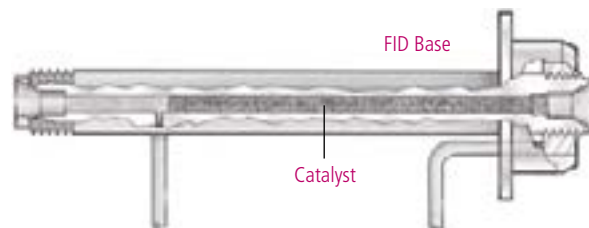

Miscellaneous Accessories

External Ignite Nozzle Replacement Tool

For removing nozzle from External Ignite FID body.

Description	Part No.
External Ignite Nozzle Replacement Tool	N6103188

Hydrogen Regulator Replacement Kit

Description	Part No.
Hydrogen Regulator Replacement Kit	N6100289

Hydrogen/Air Replacement Needle Valve

Description	Part No.
Hydrogen/Air Replacement Needle Valve	N6101412

Igniter Assembly

Complete replacement igniter assembly with glow plug.

Description	Part No.
Igniter Assembly	N6100016

Replacement Glow Plug for External Ignite FID

Description	Part No.
Replacement Glow Plug for External Ignite FID	00091279

FID Flow Measurement Adapter

Description	Part No.
FID Flow Measurement Adapter	N6101345

Clarus 480/580/680 Capillary Injector Replacement Parts*

Description	Part No.
1 Injector Cover	N6101482
2 Septum Cap	N6100153
3 PerkinElmer Green Injection Septum (pkg. 50)	N9306219
4 Injector Top Nut	N6101358
5 Injector Head	N6100158
O-ring, Silicone for Glass Liner (pkg. 10) Maximum injector temperature 250 °C***	N6101374
O-ring, Graphite for Glass Liner (pkg. 5) Maximum injector temperature 450 °C	N6101378
6 O-ring, Kalrez® for Glass Liner (pkg. 1) Maximum injector temperature 450 °C	N9302782
O-ring, Viton® for Glass Liner (pkg. 10) Maximum injector temperature 300 °C, recommended for use with Mass Spec. ships with instrument***	N9302783
Quartz Liner (2 mm) for Splitless Operation	N6121002
Quartz Liner (4 mm) for Split Operation or Large Volume Splitless Injection	N6121001
Glass Liner (2 mm) for Splitless Operation	N6101372
Glass Liner (4 mm) for Split Operation	N6101052
7 Deactivated Liner for Splitless Operation 2 mm, packed with wool. (pkg. 5)	N6121021
Deactivated Liner for Split Operation 4 mm, packed with wool. (pkg. 5)	N6121020
Deactivated Uniliner 4 mm, packed with wool. (pkg. 5)	N6121022
8 Injector Body	N6100047
9 1/8 in. Swagelok™ Nut Brass (pkg. 5)	N9300056
10 Restrictor**	N6101034
11 1/8 in. Graphite/Vespel Ferrule (pkg. 10)*	09920301
12 1/4 in. Graphite Ferrule (pkg. 10)	09920140
1/4 in. Graphite/Vespel Ferrule (pkg. 10)	09903739
13 1/4 in. Swagelok Nut, Stainless Steel (pkg. 5)	N9300055
14 Injector Adapter Cap Assembly	N6100562
15 Charcoal Trap	N6100275
Charcoal Trap for PPC Version*	N6100331
16 Split Vent Tube	N6100159
17 Column Nut 1/16 in. Long length for reversed ferrule (pkg. 5)	09903392

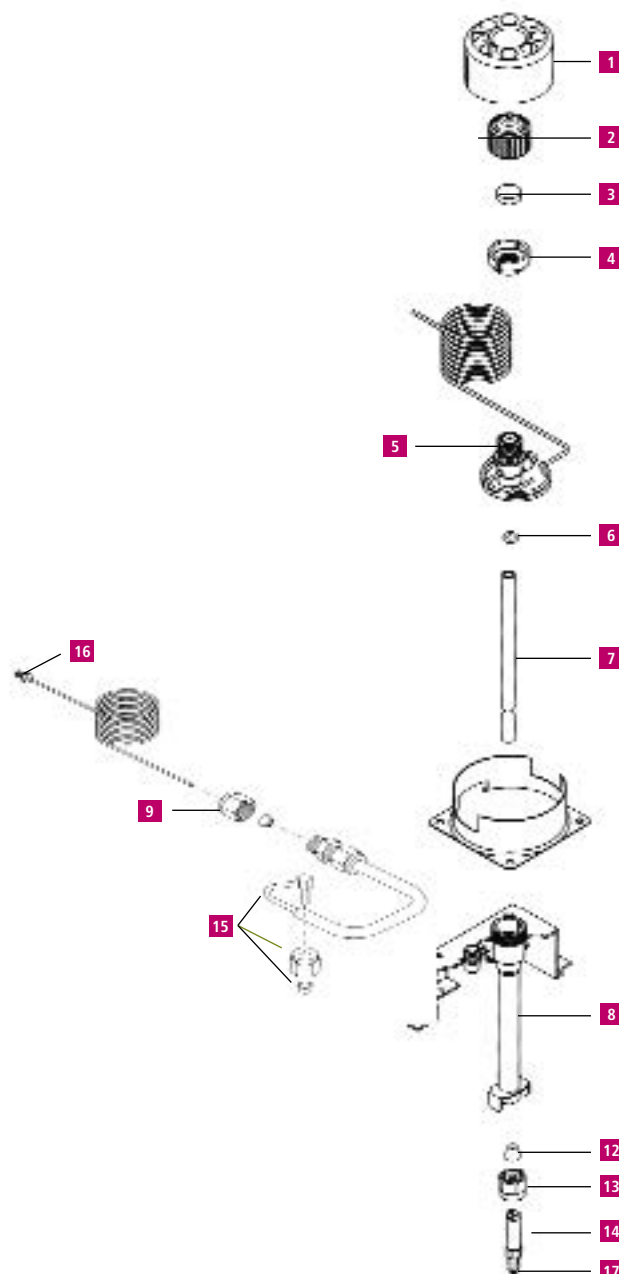

* Not suitable for Clarus 590 and 690 models.
 ** Not shown.
 Suitable for all older models to Clarus GC instruments: 480/580/680 and systems prior.
 *** O-rings are run through a crest wash and a lab test to check for phthalates.
 They are processed until they are phthalate free.

Clarus 590/690 Consumables

Sensitive, high-capacity, high-throughput GC systems delivering the power and functionality needed to meet your analytical goals. A robust autosampler delivers easy access to two injector ports, while the Clarus 690's patented high-performance oven delivers the fastest heat-up and cool-down of any oven in the business.



Description			Part No.
GC/MS PSS Injector Starter Kit			N6100447
Contents	Pkg.	Qty.	Part No.
5.0 µL Autosampler Syringe		1	N6101390
Vial Locator (dongle)		2	N6101182
PSS Injector Viton O-rings (300 °C)	10	1	N6101747
PSS Injector Kalrez® O-rings (450 °C)	1	1	09921004
PSS Split/Splitless Injector, 2 mm, no wool		1	N6121004
Graphite/Vespel Ferrules, for 0.25 mm Columns	10	2	09920104
PerkinElmer Green Septa (50 pieces)		1	N6621028
Marathon Filament		1	N6470012
Aluminum Oxide Powder (3 oz.)		1	04190197

Description			Part No.
GC/MS CAP Injector Starter Kit for Clarus 680, 580, 480*			N6100448
Contents	Pkg.	Qty.	Part No.
5.0 µL Autosampler Syringe		1	N6101390
Vial Locator (Dongle)		2	N6101182
CAP Injector Viton O-rings (300 °C)**		10	N9302783
CAP Injector Kalrez® O-rings (450 °C)		10	N9302782
CAP Split/Splitless Injector, 4 mm, no wool		2	N6121001
Graphite/Vespel Ferrules, for 0.25 mm Columns	10	2	09920104
PerkinElmer Green Septa (50 pieces)		1	N6621028
Marathon Filament		1	N6470012
Aluminum Oxide Powder (3 oz.)		1	04190197

* **N6100448** Not compatible with Clarus 590 and 690 models. Refer to the Clarus 590/690 consumable reference guide for more details.
 ** O-rings are run through a crest wash and a lab test to check for phthalates. They are processed until they are phthalate free.

Clarus 590/690 Capillary Injector Parts

Product	Description	Part No.
	Septum Cap	
1	PerkinElmer Green Injection Septum (pkg. 50)	N9306219
2	Injector Top Nut	N6550223
3	Injector Head	N6550220
4	O-ring, Viton® for Glass Liner (pkg. 10) Maximum Injector Temperature 300 °C, Recommended for use with Mass Spec.*	09200714
	O-ring, Kalrez® for Glass Liner (pkg. 1) Maximum Injector Temperature 450 °C	09200725
	Ultra-deactivated Straight Inlet Liner with wool, 4.0 mm ID, for Split/Splitless Inlets, 5 pack (ships with instrument) See page 207 for a full listing of liners	N6502036
5	Ultra Deactivated Straight Splitless Liner with wool	N6502033
	Ultra-deactivated Split Precision Liner with wool, 4.0 mm ID, 5 pack	N6502034
	Ultra-deactivated Straight Inlet Liner no wool, 1.0 mm ID, 5 pack	N6502037
	Straight Through Glass Liner no wool, 2.0 mm ID	N6502039
6	Injector Body	N6550221
7	Brass Nut	09903128
8	Front Ferrule – 1/8 in. Brass	09903129
9	Back Ferrule – 1/8 in. Brass	09903130
10	Gold Seal Nut	N6552080
11	Gold Seal	N6551043
12	1/16 in. Short Graphite/Vespel Ferrule (pkg. 10) For column ID 0.18 – 0.32 mm/0.4 mm See page 209 for a full listing of short ferrules	09200685
Not shown	Trap Installation Kit (same part for both split and splitless injection)	N6550140
Not shown	Trap Replacement Cartridge	N6550142
Not shown	Split Vent Trap Connecting Tube – 690, A Position	N6552091
	Split Vent Trap Connecting Tube – 690, B Position	N6552092
	Split Vent Trap Connecting Tube – 590, A Position	N6552093
	Split Vent Trap Connecting Tube – 590, B Position	N6552094
13	Capillary Column Nut	N6552084

* O-rings are run through a crest wash and a lab test to check for phthalates. They are processed until they are phthalate free.

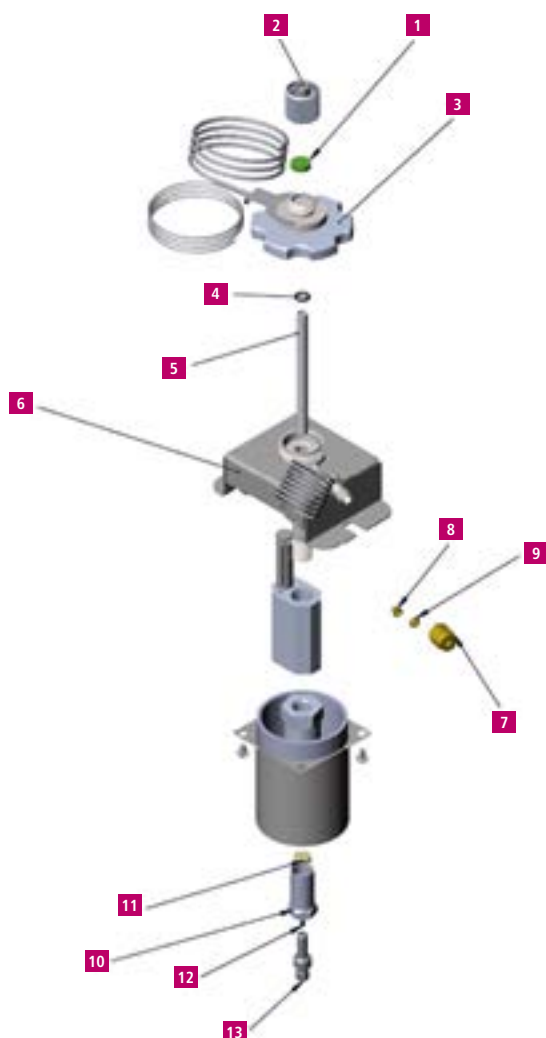

GC/MS 590/690 Capillary Injector Consumable Kit

Description	Part No.
GC/MS Capillary Injector Starter Kit for Clarus 690, 590	N6550448
Contents	Pkg. Qty. Part No.
5.0 µL Autosampler Syringe	1 N6101390
Vial Locator (Dongle)	2 N6101182
Viton O-rings (300 °C)	10 1 09200714
Kalrez® O-rings (Maximum Injector Temperature 450 °C)	1 2 09200725
Ultra Deactivated Split/Splitless Liner, 4 mm, with Wool	5 1 09200624
Graphite/Vespel Ferrules, for 0.25 mm Columns	10 1 09200685
PerkinElmer Green Septa (50 pieces)	1 N6621028
Marathon Filament	1 N6470012
Aluminum Oxide Powder (3 oz.)	1 04190197

Clarus 590/690 Split/Splitless Injector Add-On Kits

All capillary add on kits need the charcoal trap kit (Part No. **N6550140**) and the appropriate vent trap connecting tube.

Configuration	Part No.
Split Vent Trap Connecting Tube – 690, A Position	N6552091
Split Vent Trap Connecting Tube – 690, B Position	N6552092
Split Vent Trap Connecting Tube – 590, A Position	N6552093
Split Vent Trap Connecting Tube – 590, B Position	N6552094

Capillary Injector with PPC

Kit includes split/splitless injector with programmable pneumatic control for carrier gas, split vent, heater, sensor, and heater block. If not, a PPC upgrade kit (Part No. **N6120146**) is required and in addition, modules may also be required. Installation by PerkinElmer Service is required, but not included.

Voltage	Part No.
120 V	N6550138
240 V	N6550139

Capillary Injector for Manual Pneumatics

Kit includes split/splitless injector in module with heater and sensor, 0 – 60 psi pressure regulator, and transducer for pressure readout. For manual gas control.

Voltage	Part No.
120 V Clarus	N6550012
230 V Clarus	N6550013

Split/Splitless Injector Starter Kit

Includes: 2 mm ID quartz liner, 4 mm ID quartz liner, silicone O-rings, green septa (50), 0.4 mm, 0.5 mm and 0.8 mm GV ferrules, gold seal, gold seal nut, capillary injector nut and wafer scribes.

Description	Part No.
Split/Splitless Injector Starter Kit for Manual Gas Control	N6550101

Wide Range FID Add-On Kits

Auto-Ignite Wide Range FID Add-On Kit (with PPC)

Kit includes: detector assembly with heater and sensor, heater block, igniter, programmable pneumatics, amplifier and controls for detector combustion gases. GC must be PPC ready. If not, a PPC upgrade kit (N6120146) is required. Installation by PerkinElmer Service is required, but not included.

Voltage	Part No.
120 V	N6550167
240 V	N6550168

Auto-Ignite Wide Range FID Add-On Kit (Manual Pneumatics), 590 only

Kit includes: detector assembly with heater and sensor, heater block, igniter, hydrogen pressure regulator, amplifier and needle valve.

Voltage	Part No.
120 V	N6550165
240 V	N6550166

Wide Range FID Amplifier

Description	Part No.
Wide Range FID Amplifier	N6559234

Auto-Ignite Wide Range FID Replacement Parts

Description	Part No.
1 Collector Head Assembly which includes Silicone Rubber O-ring** (not shown)	N6550077 09902143
2 FID Jet Contact/Spring (included in N6550072)	N6001204
3 Jet Assembly (0.28 mm jet, fitted as standard) Jet Assembly (0.71 mm jet)	N6550080 N6550083
4 FID Body	N6550082
5 Nozzle Assembly	N6550072

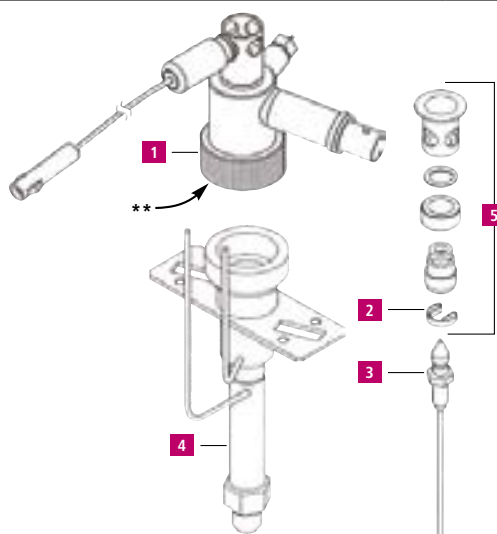

Wide Range FID Miscellaneous Accessories

Description	Part No.
Auto-Ignite Nozzle Replacement Tool for removing nozzle from auto-ignite FID body	N6103188
Auto-Ignite FID Catalytic Reactor Accessory*	N6120161
Capillary Column Adapter for capillary column use with the FID 1/8 to 1/16 in. detector adapter	N6120020
Ceramic Column Cutter	N9301376
Detector Cover (White Color)	N6103151
Eraser Brush-Pencil	09923078
Jet Assembly (0.28 mm jet, fitted as standard) Jet Assembly (0.71 mm jet)	N6550080 N6550083
Jet Replacement Tool 1/4 in. nut driver for removing jet from auto-ignite FID body	N6101297
Replacement Stainless Steel Glow Plug for Auto-ignite FID	N6103089
1/4 in. Packed Column Adapter for use with 1/4 in. packed columns. 1/8 to 1/4 in. adapter fits both injector and detector ends	00080100

Detector Series Operation Kit

TCD/FID Series Operation Kit

Used to direct sample effluent from the TCD to the FID.

Description	Part No.
TCD/FID Series Operation Kit	N6120006

PID/FID Series Operation Kit

Used to direct sample effluent from the PID to the FID.

Description	Part No.
PID/FID Series Operation Kit	N6120059

Catalytic Reactor Accessory

Auto-Ignite Wide Range FID with PPC Add-On Kit

The catalytic reactor converts CO and CO₂ to methane conveniently and efficiently. The lower detection limit is extended to well below 0.1 ppm.

The catalytic reactor consists of a special catalytic reactor base which replaces the FID base. The reactor body contains a quantity of catalyst held in place by a quartz wool plug.

Kits include base assembly, reactor tube, and instructions.

External Igniter Wide Range FID Catalytic Reactor Accessory (For Methanizer Kit)*

Description	Part No.
External Igniter FID Catalytic Reactor Accessory	N6550180

* Same part for Auto-Ignite catalytic reactor accessory

Catalytic Reactor Replacement Parts

Description	Part No.
Catalyst	N9302698
Jet Assembly (specific to methanizer/catalytic reactor)	N6100194

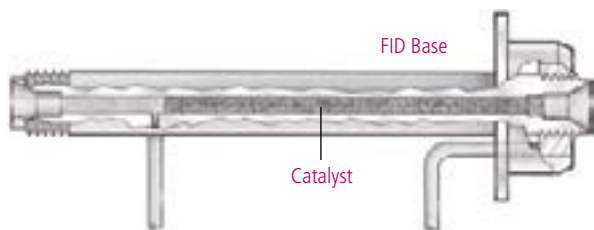

Miscellaneous Accessories

Hydrogen Regulator Replacement Kit (Manual Pneumatics)

Description	Part No.
Hydrogen Regulator Replacement Kit	N6100289

Hydrogen/Air Replacement Needle Valve (Manual Pneumatics)

Description	Part No.
Hydrogen/Air Replacement Needle Valve	N6101412

FID Flow Measurement Adapter

Description	Part No.
FID Flow Measurement Adapter	N6101345

Swafer Micro-Channel Wafer Technology

PerkinElmer's Swafer™ micro-channel wafer technology is an innovative and user-friendly approach for flowswitching and splitting applications. It delivers unparalleled hardware and application flexibility, expanding the capabilities of capillary gas chromatography (GC).



Features and Benefits

- Allows you to tackle difficult or otherwise impossible separations, delivering richer sample information which was previously unattainable
- User-friendly design and user-defined oven position allow easy setup and configuration changes, without requiring service intervention
- Complete independence of the column from injectors or detectors lets you combine injection techniques (headspace, thermal desorption, liquid, etc.), based on sample requirements
- 15 user-interchangeable configurations deliver over 18 possible modes of operation for unparalleled application flexibility
- Can be used on any Clarus 580/500 or 680/600 GC with programmable pneumatic control (PPC)
- Vent unwanted solvent or other large peak from chromatogram
- Tweak the column polarity with serial column for difficult separations

Swafer Kits for Clarus GC Systems

Description	Part No.
D-Swafer Complete Kit – for Clarus GC units only (for Clarus 680/580 GCs with PPC) Includes all required installation hardware user guides, and the D-Swafer	N6520273
S-Swafer Complete Kit – for Clarus GC units only (for Clarus 680/580 GCs with PPC) Includes all required installation hardware, user guides, and the S-Swafer	N6520272

Swafer Kits and Accessories for Existing Clarus GC Systems

Description	Part No.
Micro-Channel Kit for Existing Clarus 680/600/580/500 GC with PPC. Includes all hardware required to install a Swafer. The Swafer and installation are not included and must be purchased separately	N6520270
Micro-Channel Kit for Existing Clarus 680/600/580/500 GCs with PreVent currently installed. If PreVent is already included in the GC configuration, this hardware kit provides the additional parts required to install a Swafer. The Swafer and installation are not included and must be purchased separately	N6520271
D-Swafer Dean's Switch (Swafer only)	N9306251
S-Swafer Splitter (Swafer only)	N9306262

How Can the Swafer Help You?

Enhanced Sample Information		
Solvent venting	Vent unwanted solvent or other large peak from chromatogram	D-Swafer S-Swafer
Detector switching	Switch between your detectors of choice anytime during the run or between injections	D-Swafer
Column switching	Make your GC more flexible by choosing which column should be used to chromatograph the injected sample	D-Swafer
Heartcutting	Cut your chromatogram and analyze the cut on a different column for a better separation	D-Swafer
Polarity tuning	Tweak the column polarity with serial column for difficult separations	D-Swafer S-Swafer
Column selection	Better utilize large and expensive detectors by choosing which of the two columns to monitor	D-Swafer
Carrier-gas swapping	Use a different carrier gas in the injector or sampling system from that used for the chromatography	D-Swafer
Peak attenuation	Analyze a wide dynamic range by diluting portions of your chromatography	D-Swafer
Splitting	Split your chromatography between up to four channels (detectors, sniffer ports, etc.)	S-Swafer

Throughput and Maintenance		
Column backflushing	Remove unwanted compounds from the column after the analytes have eluted	D-Swafer S-Swafer
MS isolation	Perform your MS, column and inlet maintenance without venting for less downtime	D-Swafer S-Swafer
Retention-gap purging	Remove large amounts of solvent with cold on-column injection	D-Swafer
Inlet selection	Automate your inlet choices (headspace, thermal desorption, liquid autosampler, etc.) between injections	D-Swafer
Injector maintenance or enhanced large volume injection	Enable injector septa or liner exchange while the system is still active Prevent solvent vapor from entering column and detector during injector purging	D-Swafer S-Swafer

Heartcutting (D-Swafer) allows separation of selected peaks within a complex sample matrix.

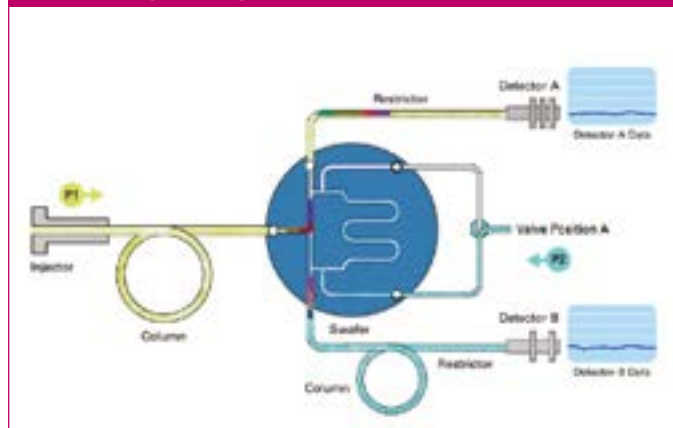

Swafer can be installed in any Clarus 580/500 or 680/600 GC with programmable pneumatic control (PPC).



TurboMatrix 40 Headspace Trap

Sample Head Assembly Replacement Parts

	Description	Part No.
	Platinum/Iridium Needle, Wide-bore	B0144169
	Platinum/Iridium Needle, Small-bore	B0500959
	Platinum/Iridium Needle, Jet	B0510364
1	Silcosteel Needle, for Headspace Trap Only	N6700130
	Stainless Steel Needle, Wide-bore	B0131385
	Stainless Steel Needle, Small-bore	B0500987
	Stainless Steel Needle, Jet (ships with instrument)	B4000011
2	Needle Seal Assembly (without O-rings)	B0500833
3	O-ring for Needle Seal Assembly (pkg. 10)	B0198110
4	Vespel Ferrule 1/16 in. (pkg. 10)	09920127
5	Male Nut 1/16 in.	N9302832
6	GLT Adapter Tube	B0503956
	GLT Adapter Tube, Silcosteel	N6700113
7	Graphite/Vespel Ferrule 1/16 in. x 0.4 mm For use with 0.25 mm ID Transfer Line (pkg. 10)	09920104
	Graphite/Vespel Ferrule 1/16 in. x 0.5 mm For use with 0.32 mm ID Transfer Line (pkg. 10)	09920105
8	Nut 1/16 in. Swagelok	N9300059
	0.18 mm ID x 5 m Length	N9301354
9	Fused-Silica Capillary Transfer Line: 0.25 mm ID x 5 m Length	N9301356
	0.32 mm ID x 5 m Length	N9301357
	0.53 mm ID x 5 m Length	N9301358

Headspace Sample Head Assembly Schematic

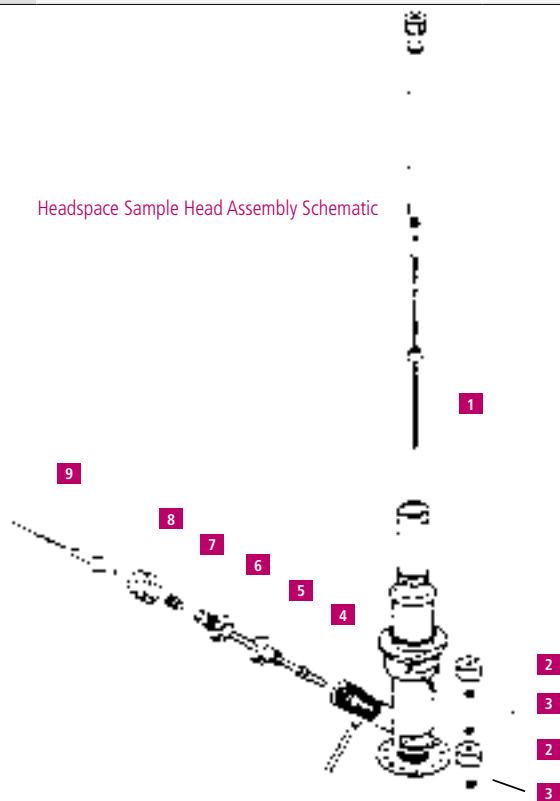

Solid Glass Blocking Trap

Description	Part No.
Block for Use in Standard Headspace Mode	N6701170

Sample Trays

For use on the Mid-Range or High-Capacity headspace sampler.

Description	Part No.
TurboMatrix 40 Mid-Range Sample Tray	M0413592
TurboMatrix 110 High-Capacity Sample Tray	M0413593

Transfer Lines

Description	Tubing ID (mm)	Length	Part No.
Siltek Deactivated Fused Silica	0.25	5 m	N9316607
Siltek Deactivated Fused Silica	0.32	5 m	N9316608

Miscellaneous Accessories

Description	Part No.
Gas Chromatography – Theory and Practice, Static Headspace Book by L. Ettre and B. Kolb	N1011210

Cold Trap Options

Headspace Trap instruments only.

Description	Part No.
TurboMatrix HS Trap Cold Trap Tube (Carbopack C)	N6200150
TurboMatrix HS Trap Air Monitoring Trap*	M0413628

* Trap comes standard with instrument.

Packed Column Injector for All Clarus GC Models

Packed Column Injector Kit with Manual Pneumatics

Includes: complete injector assembly with heater and sensor, 0 – 100 mL flow controller, and column head pressure gauge for installation into the AutoSystem.

Voltage	Part No.
120 V*	N6120007
230 V*	N6120023

Packed Column Injector Kit with PPC

The kit includes complete injector assembly with programmable pneumatic control, heater, sensor, and heater block. The GC must be PPC™ ready. If not, a PPC upgrade kit (**N6120146**) is required.

Voltage	Part No.
120 V*	N6120136
230 V*	N6120137

Packed Column Injector Kit with Screen Readout and Manual Pneumatics

Includes: complete injector assembly with heater and sensor, 0 – 100 mL flow controller and column head pressure gauge, and transducer for screen readout of column carrier flow.

Voltage	Part No.
120 V* Clarus	N6520010
230 V* Clarus	N6520011

Packed Column Injector Kit AutoSystem XL and Clarus

The kit includes complete injector, heater, sensor, and heater block. (Does not include pneumatics).

Voltage	Part No.
120 V*	N6120071
230 V*	N6120072

Packed Column Injector Starter Kit

Includes glass liner, needle guide, green septa (50), untreated quartz wool, and packing rod.

Description	Part No.
Packed Column Injector Starter Kit	N6120100

*Service installation suggested.

Packed Injector Replacement Parts

	Description	Part No.
1	Septum Cap	N6100153
2	PerkinElmer Green Injection Septum (pkg. 50)	N9306219
3	Needle Guide	N6101050
4	Glass Liner (6 mm OD, 3 mm ID, 112 mm Length)	N6101048
	Quartz Liner (6 mm OD, 3 mm ID, 112 mm Length)	N6121000
5	Packed Injector Assembly	N6100048

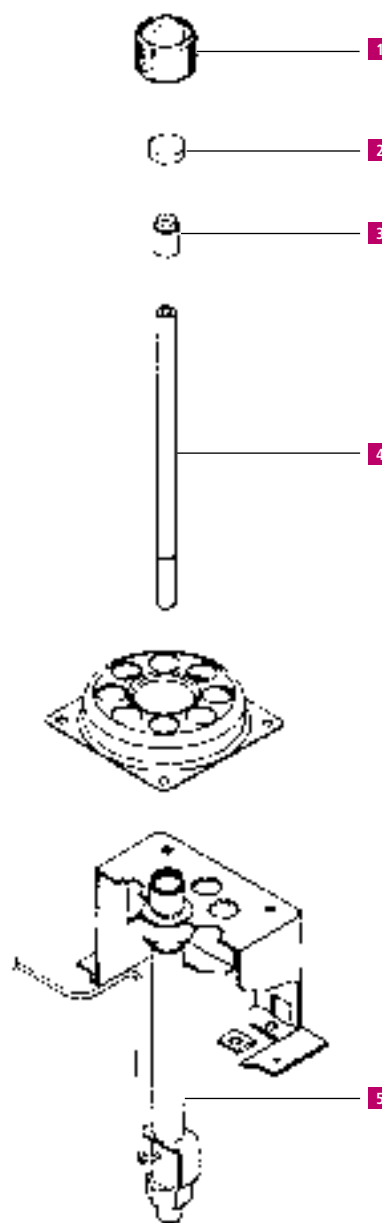

PSS Spares for All Clarus GC Models

PSS Injector Add-On Kits with Manual Pneumatics

The programmed-temperature split/splitless (PSS) inlet allows accurate sample delivery to a capillary column. The PSS allows the analysis of thermally labile compounds, while eliminating the discrimination of high-boiling compounds. One of the major advantages of the PSS is that any nonvolatile material will remain in the inlet liner and not on the front of the column.

PSS with pneumatics and pressure readout on screen.

Kit includes all necessary hardware to install injector into GC.

Voltage	Part No.
120 V* Clarus	N6520014
230 V* Clarus	N6520015

PSS Injector with PPC

Kit includes injector with programmable pneumatic control, heater, sensor, and heater block. The GC must be PPC™ ready. If not, a PPC upgrade kit (**N6120146**) is required.

Voltage	Part No.
120 V*	N6550053
230 V*	N6550054

PSS Injector Starter Kit

Includes: universal connectors (5), 0.53 mm ID deactivated fused-silica (5 m), 2 mm ID quartz liner, 1 mm ID quartz liner, glass hourglass liner, 1/16 in. stainless steel nuts (5), 0.5 mm ID graphite ferrules (10), 0.8 mm ID graphite ferrules (10), Viton® O-rings (6), graphite O-rings (5), untreated quartz wool, wafer scribes (10), and green septa (50).

Voltage	Part No.
PSS Injector Starter Kit	N6120102

Zero Dilution Liners

Used together as set.

Voltage	Part No.
Inner Liner	N1011446
Outer Liner	N1011447

* Service installation suggested.

PSS Replacement Parts

Description	Part No.
1 Septum Cap	N6100153
2 Injector Cover	N6101482
3 PerkinElmer Green Injection Septum (pkg. 50)	N9306219
4 Trap, Charcoal – non PPC version	N6100275
PPC version (not shown)	
5 Nut	N6101705
6 Septum Purge	N6100260
O-ring Viton (pkg. 10) max temp 300 °C, recommended for use with mass spec. Shipped with instrument*	N6101747
7 O-ring Kalrez® (pkg. 1) max temp. 450 °C	09921004
O-ring Graphite (pkg. 5) max temp. 450 °C	N6101751
Quartz Liner, 2 mm Split Mode Shipped with instrument.	N6121004
8 Quartz Liner, 1 mm Splitless Mode	N6121006
On-column liner	N6101539
9 PSS Body Braze Assembly	N6550025
10 Ferrule 1/8 in. x 1/16 in. (pkg. 10)	09920301
11 Nut 1/8 in.	09903128
12 Split Vent Line	N6100159
13 Purge Restrictor	N6101034
14 Nut	09903392

* O-rings are run through a crest wash and a lab test to check for phthalates. They are processed until they are phthalate free.

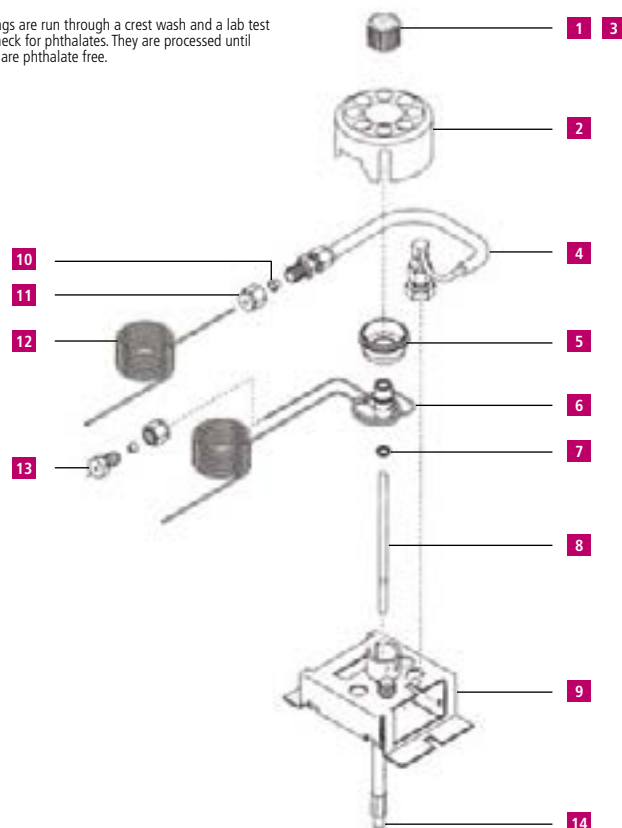

POC Spares for All Clarus GC Models

Programmed-Temperature On-Column (POC) Inlet is designed to be used with fused-silica capillary columns. The sample is injected onto the column while the inlet is cool. After the injection, the inlet begins to heat. This delay in heating avoids the flash vaporization associated with a normal injection. This explosive vaporization can cause thermal breakdown and/or discrimination of certain analytes, which can be avoided by using the POC.

The POC Injector is best used to achieve recovery of compounds of greater than C60 (e.g., polywaxes). The POC utilizes flow control, producing the best recovery out to C100 or greater.

POC Injector with Manual Flow Controller and Head Pressure Gauge

Kit includes all necessary hardware to install injector into AutoSystem Series or Clarus Series.

Voltage	Part No.
120 V*	N6120076
230 V*	N6120077

POC Injector with Manual Flow Controller and Head Pressure Gauge with Flow Readout on Screen

Kit includes all necessary hardware to install injector into AutoSystem Series or Clarus Series.

Voltage	Part No.
120 V*	N6120082
230 V*	N6120083

POC Injector with PPC Add-On Kit

Kit includes injector with programmable pneumatic control, heater, sensor, and heater block. The AutoSystem XL or Clarus GC must be PPC™ ready. If not, a PPC upgrade kit (**N6120146**) is required. Installation by PerkinElmer Service is required, but not included.

Voltage	Part No.
120 V*	N6550049
230 V*	N6550050

POC Injector Starter Kit

Includes: needle guides (5), universal connectors (5), 0.53 mm ID deactivated fused silica (5 m), 1/16 in. stainless steel nuts (5), 0.8 mm graphite ferrules (10), green septa (50), and wafer scribes (10).

Voltage	Part No.
POC Injector Starter Kit	N6120098

* Service installation suggested.

POC Replacement Parts

Description	Part No.
1 Septum Cap	N6100153
2 PerkinElmer Green Injection Septum (pkg. 50)	N9306219
3 Needle Guide	N6101702
4 Liner/Hour Glass	N6101703
Body Assembly	N6100256
5 Packed Injector Assembly	N6100048

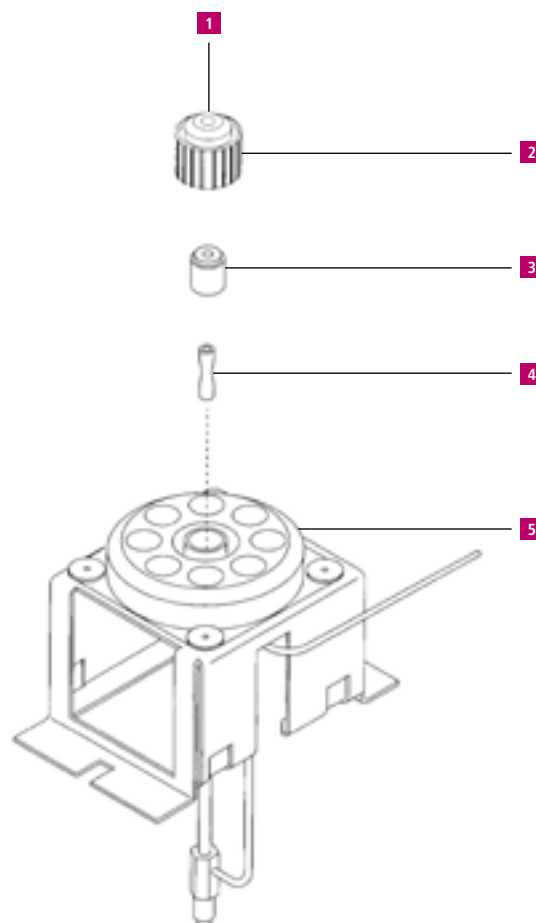

FPD Spares for All Clarus GC Models

The FPD is a highly sensitive and selective detector for both sulfur and phosphorus compounds. It is especially suitable for environmental monitoring of H₂S and sulfur gases in general and for organophosphorus compounds present at trace levels in pesticide analysis. Alkyl tin compounds can also be analyzed by changing the filter assembly. The sulfur filter is shipped standard.

The FPD mounts in either the front or rear detector position. This allows many detector combinations, such as FPD/FPD, FPD/TCD, and FPD/ELCD.

The AutoSystem also includes a linearizer function for the sulfur mode and convenient control of the photomultiplier tube from the keyboard.

The FPD is capillary-column compatible. The detector will accept columns of 0.530 mm ID or less. As a reminder, use of packed 1/4 in. columns requires a 1/8 to 1/4 in. adapter.

Filters

Description	Part No.
Phosphorus Lens (Yellow)	N6000981
Sulfur Lens* (Blue)	N6000637
Tin Lens (Orange)	L4135472

* Shipped standard.

FPD Add-On Kit (Manual Pneumatics)

Kit includes detector, heater, sensor, heater block, hydrogen needle valve, air pressure regulator, and sulfur photomultiplier filter. Requires but does not include FPD amplifier. Firmware revision 1.6 or greater required. Firmware must be PerkinElmer Service installed. AutoSystem operator's manual (**09938559**) revision E or higher required.

Voltage	Part No.
120 V Clarus	N6520028
230 V Clarus	N6520029

FPD Amplifier

Firmware revision 1.6 or greater required. Firmware must be PerkinElmer Service installed. AutoSystem operator's manual (**09938559**) revision E or higher required.

Description	Part No.
FPD Amplifier	N6109094
FPD ASSY SNAPL 120V	N6550040
FPD ASSY SNAPL 230V	N6550041

FPD Replacement Parts for AutoSystem Series GCs

Description	Part No.
1 O-ring	09902247
2 Seal Assembly and Window (heat shield)	N9300096
3 Liner (window)	N6003057
4 FPD Body (upper)	N6100243
5 Window Holder	N6003066
6 FPD Jet Assembly	N6550055
7 FPD Body (lower)	N6100244
8 Photomultiplier Tube	09972321

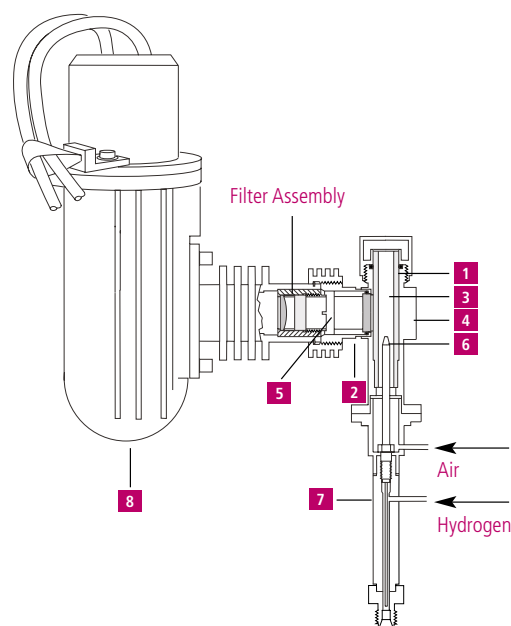

FPD with PPC Add-On Kit

Kit includes: detector, heater, sensor, heater block, programmable pneumatic control for detector combustion gases, and sulfur photomultiplier filter. Requires, but does not include, FPD amplifier. AutoSystem XL GC must be PPC ready. If not, a PPC upgrade kit (**N6120146**) is required. Installation by PerkinElmer Service is required, but not included.

Voltage	Part No.
120 V	N6520036
230 V	N6520037

Packed Column Adapter

1/8 to 1/4 in. adapter for use with 1/4 in. packed columns.

Description	Part No.
Adapter (set of 2)	00080100

TCD for All Clarus GC Models

Features and Benefits

- Lower Internal Volume and Smaller Overall Size
- No Makeup Gas Required with 0.53 mm and 0.32 mm ID Capillary Columns
- Series Connection Option
- Excellent Sensitivity Over a Wide Dynamic Range

TCD Add-On Kit (Manual Pneumatics)

Kit includes all necessary items to install the TCD into the instrument: detector, heater, sensor, heater block, 1/16 in. gas line, and flow controller pneumatics. Requires, but does not include, amplifier (**N6120015**). The TCD can only be installed in the rear detector position.

Voltage	Part No.
120 V Clarus	N6520022
230 V Clarus	N6520023

TCD Amplifier

Description	Part No.
TCD Amplifier	N6120015

TCD with PPC Add-On Kit

Kit includes: detector, heater, sensor, heater block, and programmable pneumatic control for reference gas. Requires, but does not include, amplifier (**N6120015**). The TCD can only be installed in the rear detector position. The GC must be PPC ready. If not, a PPC upgrade kit (**N6120146**) is required. Installation by PerkinElmer Service is required, but not included.

Voltage	Part No.
120 V	N6120124
230 V	N6120125

TCD with PPC Makeup Gas Kit

Includes parts required to add PPC controlled makeup gas to an existing TCD. Includes tubing, tee-piece, PPC pneumatics module, and PPC frit #4 (**N6120155**). Requires PPC capability in the GC.

Description	Part No.
TCD with PPC Makeup Gas Kit	N6120150

Column Adapter

Description	Part No.
1/8 to 1/4 in. Column adapter for use with 1/4 in. packed columns	00080100
1/8 to 1/16 in. Column adapter for use with capillary columns	N6120020

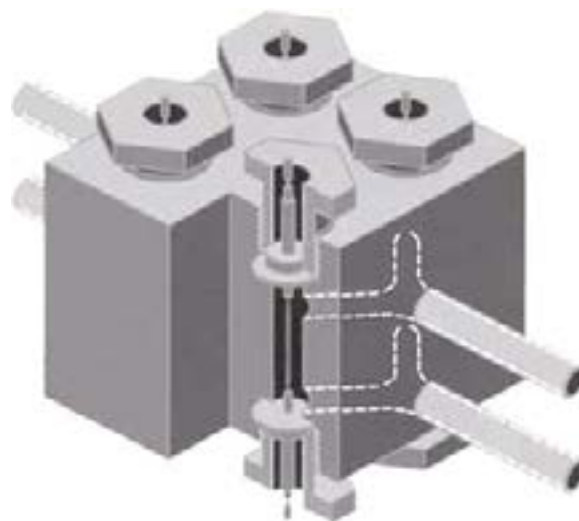

Thermal Conductivity Detector

TCD/FID Series Operation Kit

TCD and FID series operation kit for directing effluent from a TCD to an FID.

Description	Part No.
TCD/FID Series Operation Kit	N6120006

TCD Detector Makeup Gas Kit (Manual Pneumatics)

For use with TCD (at low flow rates). Required when using 0.25 mm ID and recommended when using 0.32 mm ID capillary columns. Kit includes 1 m of 1/16 in. tubing to connect to gas supply, graphite/vespel ferrules, manual pneumatics, and installation instructions.

Description	Part No.
TCD Detector Makeup Gas Kit (Manual Pneumatics)	N6120080

ECD Spares for All Clarus GC Models

The ECD is a versatile, nondestructive detector which responds strongly to halogen-containing compounds as well as to certain other electron-capturing substances. The ECD's high sensitivity and selectivity make it an ideal choice for pesticide-residue analysis and for detection of halogen-derivatized compounds.

The ECD has an independent temperature range of 100 – 450 °C. The detector contains thermal protection that prevents heating the Ni63 source to temperatures beyond safe operating limits. Two ECDs can be installed and operated simultaneously on the AutoSystem Series and Clarus GCs. Nitrogen or argon/methane is the required detector operating gas. The base of the detector terminates in a 1/8 in. fitting.

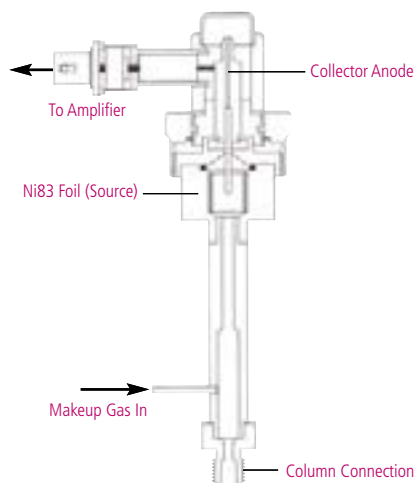

ECD Add-On Kit (Manual Pneumatics)

Kit includes all parts necessary to install an ECD on the AutoSystem Series or Clarus GCs. Includes: detector, heater, sensor, heater block, 1/16 in. makeup gas line, makeup gas needle valve, and vent tube assembly. Requires, but does not include, ECD amplifier (N6120014). Installation by PerkinElmer Service is recommended.

Voltage	Part No.
230 V Clarus	N6520021

ECD Amplifier

Required for use with ECD detector with add-on kit.

Description	Part No.
ECD Amplifier	N6120014

ECD Add-On Kit (PPC Pneumatics)

Kit includes: detector, heater, sensor, heater block, and programmable pneumatic control for makeup gas. Requires, but does not include, ECD amplifier (N6120014). The AutoSystem XL or Clarus GCs must be PPC ready. If not, a PPC upgrade kit (N6120146) is required. Installation by PerkinElmer Service is required, but not included.

Voltage	Part No.
120 V	N6120122
230 V	N6120123

Vent Tube Assembly

Flexible tube to safely vent toxic sample effluent.

Description	Part No.
Vent Tube Assembly	N6100161

Column Adapters

Column Adapter/Receiver

Adapter converts 1/8 in. fitting to 1/16 in. for use with capillary columns. **Note:** Glass-lined tubing reduces background from polyimide coating in high-temperature applications.

Description	Part No.
Capillary Column Adapter/Receiver	N6000968

1/4 in. Packed Column Adapter

For use with 1/4 in. packed columns. 1/8 to 1/4 in. adapters fit both injector and detector ends. (pkg. 2).

Description	Part No.
1/4 in. Packed Column Adapter	00080100

ECD Wipe Test Kit

U.S. Federal law requires that all ECDs be wipe-tested periodically as described in the instrument operator's manual. In the U.S., possession and use of ECD is regulated by N.R.C. and/or state regulatory agencies. Licensing by regulatory agencies is required. Outside of the U.S., check with governing bodies for licensing and regulations covering possession and use. This kit contains everything necessary to do a complete wipe test. For use on any model GC ECD.

Description	Part No.
ECD Wipe Test Kit	00091667

NPD Spares for All Clarus GC Models

The NPD can be used for the analysis of organic compounds containing nitrogen or phosphorus down to the picogram level. The NPD has become the detector of choice for low-level drug and pesticide applications because of its sensitivity and selectivity.

NPD Amplifier

Required for use with NPD Add-On Kit.

Description	Part No.
NPD Amplifier	N6120094

NPD with PPC Add-On Kit

Kit includes: detector, heater, sensor, heater block, and programmable pneumatic control for detector combustion gases and two beads. Requires, but does not include, amplifier (**N6109264**). The AutoSystem XL or Clarus GC must be PPC ready. If not, the PPC upgrade kit (**N6120146**) is required. Installation by PerkinElmer Service is required, but not included.

Voltage	Part No.
120 V	N6120126
230 V	N6120127

Column Adapter

1/4 in. Packed Column Adapter

1/8 to 1/4 in. detector receiver adapter for use with 1/4 in. packed columns. Two included (injector/detector).

Description	Part No.
1/4 in. Packed Column Adapter	00080100

NPD Replacement Parts

Description	Part No.
1 Collector Head	N6100253
2 Bead Assembly (pkg. 5)	N6120093
Single pkg.	N6120092
3 Jet Assembly	N6100038
4 NPD Body	N6100228

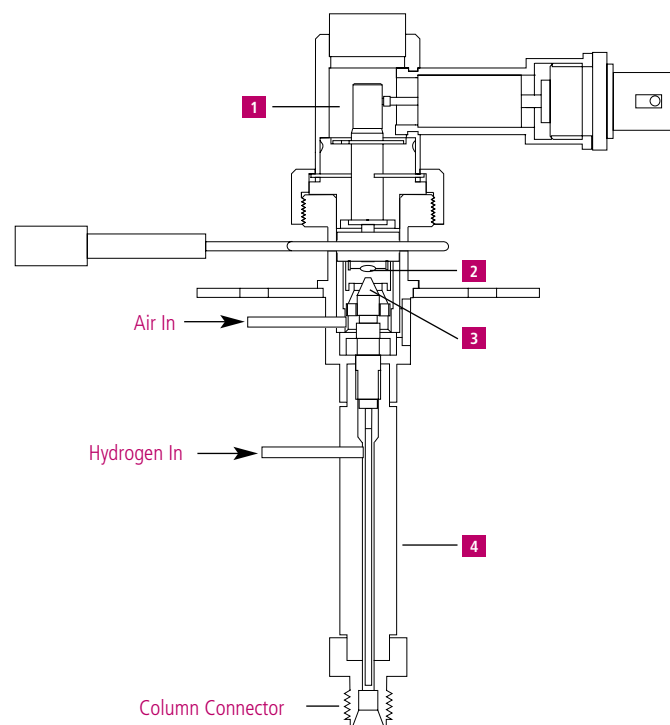

PID Spares for All Clarus GC Models

PID Add-On Kit (Manual Pneumatics)

The PID utilizes a high-intensity ultraviolet light source to ionize the sample components eluting from the column in order to generate the chromatographic signal. The PID has a maximum recommended operating temperature of 250 °C. The lamp can be replaced with a blanking disk to allow bake-out operation (up to 350 °C). Kit includes: detector, heater, sensor, makeup gas needle valve, and all necessary mounting hardware for installation on an AutoSystem GC. Requires, but does not include, amplifier (**N6120061**) and lamp power supply (**N6120062**). Firmware revision 1.2 or greater is required. Firmware must be PerkinElmer Service installed. AutoSystem operator's manual (**09908559**) is required if not revision F or higher.

Voltage	Part No.
120 V Clarus	N6520026

PID Amplifier

Required for use with PID Add-On Kit.

Description	Part No.
PID Amplifier	N6120061

PID Lamp Power Supply

Required for use with PID Add-On Kit.

Description	Part No.
PID Lamp Power Supply	N6120062

PID with PPC Add-On Kit

Kit includes: detector, heater, sensor, heater block, and programmable pneumatic control for makeup gas. Requires, but does not include, amplifier (**N6120061**) and power supply kit (**N6120062**). The GC must be PPC ready. If not, a PPC upgrade kit (**N6120146**) is required. Installation by PerkinElmer Service is required, but not included.

Voltage	Part No.
120 V	N6120130

Miscellaneous Accessories

Description	Part No.
Bakeout Disk	03302989
Lamp Cleaning Compound	03302775
1/8 in. Detector Receiver	03300865

PID Replacement Parts

Description	Part No.
1 PID Lamp (10.2eV), For most applications including aromatics, alkenes, and aliphatics higher than C4. Shipped standard with PID	03303599
PID Lamp (9.5eV), Improved selectivity for multiple ring aromatic, sulfur compounds	03303598
2 PID Lamp Window Seal	03302778
3 PID Lower Lamp Seal	03302777
4 Shoulder Pin	03302976
5 Cap Nut	03303773
6 Base Assembly	03302979
7 Spring	03302973
8 Cap with Harness	N6101696

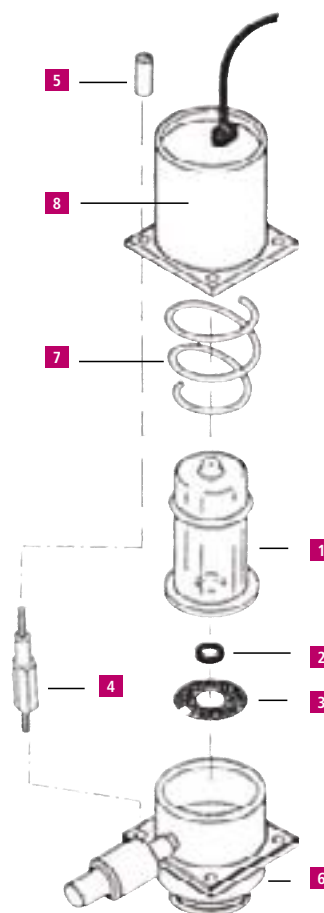

Swagelok Fittings

The patented advanced-geometry back ferrule design provides a leak-tight tube connection on all Swagelok™ stainless steel tube fittings, in sizes 1/4 to 1/2 in., and 6 to 12 mm. Leak-tight seals that will withstand high-pressure, vibration, vacuum and temperature changes depend upon close tolerances and consistent, exacting quality control in conjunction with good design principles. Swagelok fittings from PerkinElmer are available in brass and stainless steel.

Features and Benefits

- Ease of installation
- Back ferrule axially advances the front ferrule
- Vibration fatigue resistance
- Wide variety of configurations

Swagelok™ Fittings

Product	Qty.	Size	Brass Part No.	Stainless Steel Part No.
Bulkhead Adapter	pkg. 1	1/4 in. to 1/4 in. tube		N9301267
Back Ferrule	pkg. 5	1/16 in. 1/8 in. 1/4 in.	N9300040 N9300036 N9300030	N9300042 N9300038 N9300032
Cross Union	pkg. 1	1/8 in.	N9301259	
Front Ferrule	pkg. 5	1/16 in. 1/8 in. 1/4 in.	N9300041 N9300037 N9300031	N9300043 N9300039 N9300033
Male Adapter Tube to Pipe	pkg. 1	1/4 in. tube to 1/8 in. NPT	N9301266	
Male Connector	pkg. 1	1/8 in. to 1/8 in. NPT 1/8 in. to 1/4 in. NPT 1/4 in. to 1/8 in. NPT 1/4 in. to 1/4 in. NPT	N9301253 N9301254 N9301255 N9301269	
Nut	pkg. 5	1/16 in. 1/8 in. 1/4 in.	N9300058 N9300056 N9300054	N9300059 N9300057 N9300055
Plug	pkg. 1	1/16 in. 1/8 in. 1/4 in.	N9300060 N9301268	N9300053 N9300061 N9301233
Union	pkg. 2	1/16 in. 1/8 in. 1/4 in.	N9300048 N9300046 N9300044	N9300049 N9300047
Union Tee	pkg. 1	1/16 in. 1/8 in. 1/4 in.	N9301221 N9301222 N9301223	
Reducing Union	pkg. 1	1/8 in. to 1/16 in. 1/4 in. to 1/8 in. 1/4 in. to 1/16 in.	N9300051 N9300050 N9301227	N9301225 N9301226

Thermal Desorption

PerkinElmer offers a wide selection of superior quality products designed to work with your PerkinElmer instruments. Our precision designed products deliver the peace of mind that comes from knowing that you'll get the results you need.

Quick Reference Index

	Page
▶ ATD Tubes	123
▶ Cold Traps Fittings and Accessories	121
▶ Conditioned Thermal Desorber Tubes	124
▶ Packed Traps for PerkinElmer Thermal Desorbers	121
▶ Soil Vapor Intrusion (SVI™) Tubes	124
▶ Thermal Desorber Caps and Accessories	122
▶ Thermal Desorber Starter Kit	122
▶ TurboMatrix Thermal Desorption Cold Trap Supplies	121
▶ Unconditioned Thermal Desorber Tubes	123

Thermal Desorber Starter Kit

Our convenient starter kit includes all the products you need to run the TurboMatrix Thermal Desorber.



[▶ VIEW PAGE](#)

TurboMatrix Thermal Desorption Cold Trap Supplies

Used for U.S. EPA Method TO17, the PerkinElmer standard trap, packed with Tenax™ on the TurboMatrix™ Thermal Desorber, improves productivity and trapping capacity. The TurboMatrix air monitoring trap is packed with carbonaceous sorbents suitable for ozone precursor and air toxics monitoring.

[▶ VIEW PAGE](#)

Conditioned Thermal Desorber Tubes

Stainless steel and glass sample tubes are available with a wide variety of packing materials from single to multi-bed.



[▶ VIEW PAGE](#)

XRO™-440 and 640 Tubes

The new and unique Extended Range Organics XRO-440 and 640 Tubes have been designed to accommodate a target component range from nC₄ to nC₄₄ and nC₆ to nC₄₄, respectively. They are suitable for methods such as TO-17 and EPA-325.

[▶ VIEW PAGE](#)

Packed Traps for PerkinElmer Thermal Desorbers

Air Monitoring Trap

Low flow trap packed with carbonaceous sorbents suitable for ozone precursor and air toxin monitoring.

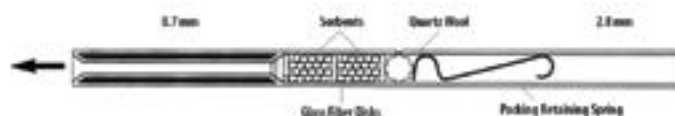

Low Flow Cold Trap

TurboMatrix Thermal Desorption Cold Trap Supplies

Trap supplies from PerkinElmer, the market leader in thermal desorption, will provide exceptional analytical performance. Used for U.S. EPA Method TO17, the PerkinElmer standard trap, packed with Tenax™, on the TurboMatrix™ Thermal Desorber, will improve productivity and trapping capacity. The TurboMatrix air monitoring trap is packed with carbonaceous sorbents suitable for ozone precursor and air toxics monitoring.

Description	Qty.	Part No.
Cold Traps for TurboMatrix		
Air Monitoring Trap	1	M0413628
Empty Trap	1	M0413627
Tenax™ TA 60/80 Packed Trap	1	M0413535
Carbopack® C Packed Trap	1	N6200150
Cold Traps for ATD 400		
Air Monitoring Trap	1	L4275108
Trap Nuts (2 required)	1	L4275009
Trap Tube Low Flow, Empty (Narrow-bore at one end. Allows minimum gas flow during trap desorption)	1	L4275107
Tenax™ TA 60/80 Packed Trap	1	L4275089
Empty Trap	1	L4271106



Cold Traps Fittings and Accessories

Description	Qty.	Part No.
Graphite Ferrule	2	L4271187
SilTite™ Ferrule (GC/MS) 0.4 mm	10	N9306093
SilTite™ Ferrule (GC/MS) 0.5 mm	10	N9306094
SilTite™ Ferrule (GC/MS) 0.8 mm	10	N9306095
SilTite™ Nuts	5	N9306096
PTFE Ferrule	10	L4275110
Graphite/Vespel® Ferrule for ATD 400	5	L1003027
Valco® Graphite/Vespel® Ferrule for ATD 400	5	L1003028
Trap Filter Disk		L1003030
Trap Packing Disk	20	L4271290
Trap Packing Retaining Spring	5	N6301054
Cold Trap Packing Tool		L4271203
Cold Trap Removal Tool		L4271205
Regulator 0 – 60 psig		N6101474
Replacement Plastic Plunger for Gauze Loading Rig		L4071151



Thermal Desorber Starter Kit

Our convenient starter kit includes all products you need to run the TurboMatrix Thermal Desorber.

Features and Benefits

- All items available under one part number in a convenient kit
- Guaranteed PerkinElmer parts
- Improved chromatography with exceptional analytical performance using PerkinElmer parts

Description			Part No.
Thermal Desorber Starter Kit			N6100448
Contents	Pkg.	Qty.	Part No.
Glass Fiber Separator Disks	20	1	L4271290
Glass Sample Tubes	10	1	M0413598
Glass Wool	1	1	54120790
Graphite Ferrules	2	1	L4271187
O-ring	5	1	L1003006
O-ring, Viton	1	1	L1003008
Packing Gauze	100	1	L4071034
PTFE Filter Discs	10	1	L1003030
PTFE Filter Discs – Large	10	1	L1003029
Retaining Spring	50	1	L4071123
Sample Tube – 5 mL	1	1	04970673
Stainless Steel Retaining Spring	2	1	N6301054
Stainless Steel Sample Tubes – Capped	10	1	M0413595
Tenax TA 60/80, Mesh – 10 g	1	1	04978064
Trap Tube Nuts	2	1	L4275009
Trap Tubes	2	1	M0410094

Thermal Desorber Caps and Accessories

Description	Pkg.	Part No.
Brass Long-Term Storage Caps Recommended for long-term storage, two required per tube. Also requires PTFE Ferrule (L1003015)	1	09908851
Combined PTFE Ferrule For use with ¼ in. Brass Long-Term Storage Caps (09908851), two required per tube	5	L1003015
Diffusion Caps – Standard For passive air sampling, to ensure correct diffusion path length	10	L4070207
Diffusion Caps with Membrane as above, with silicone membrane inserted	10	L4070208
Pen Clips For Stainless Steel Thermal Desorber Tubes	10	L4071029
PFA PTFE Ferrules For TurboMatrix Storage End Caps	20	M0413625
TurboMatrix Analytical Caps PTFE Caps with O-ring, Required for Use on the TurboMatrix Instrument During Analysis	20	N6200119
Parofluor O-ring, 0.145 ID x 0.070 WD		09200091
Parofluor O-ring, 0.208 ID x 0.0707 WD		09200092
O-ring 0.208 ID x 0.0707 WD (Viton)	5	L1003006
Parofluor O-ring, 0.301 ID x 0.070 WD		09200093
O-ring 0.301 ID x 0.070 WD (Viton)	5	L1003008
Viton O-ring (for analytical end caps)	50	04970343
TBMTX TD 4.5 Coated SS Disk		N6711147
TBMTX TD Coated SS Disk Filter		N6711148
1/8 in. Graphite Ferrule		09920593

ATD Tube Conditioning Oven

PerkinElmer's new ATD tube conditioning oven now conditions tubes faster and easier than ever before. ATD tubes must be re-conditioned after analysis to remove contaminants before they are used for sampling. You can do this one of two ways. You can condition each tube individually on your thermal desorption instrument. This takes time – especially if you have several tubes to condition – and also ties up your instrument which could be used for more important analysis. Or, a better more efficient alternative is to condition your tubes in a separate oven.



Features and Benefits

- Condition any number or combination of stainless steel and glass tubes simultaneously without wasting gas
- Hood interlock protects anyone in the lab from opening the oven until it's cool
- Dual automatic fan design cools the oven in minutes
- Oven vent through the top hood ensuring a contaminant free oven

Description	Part No.
TurboMatrix TC 220 (120 V)	N9309160
TurboMatrix TC 220 (230 V)	N9309161

Specifications	
Capacity	Holds up to 20 tubes
Temperature Range	Ambient – 400 °C
Programming	4 Ramps + 4 Soaks
Flow Rate	25 – 150 mL/min

Unconditioned Thermal Desorber Tubes

For your convenience, new low-cost thermal desorber tubes are offered in both stainless steel and glass. Each tube maintains its unique serial number which is etched for easy identification. Tubes are offered with a variety of sorbent packing materials for many GC applications including indoor and outdoor air monitoring, analysis of flavors and fragrances and the analysis of outgassing from packaging, polymers, pharmaceuticals and semi-conductor material. These tubes are unconditioned and ship with plastic end caps for short-term storage.



Packed Unconditioned Sample Tubes, Plastic End Caps (pkg. 10)

Description	Stainless Steel Part No.	Glass Part No.
Air Toxics	N9307050	N9307058
Carbopack™ B60/80	N9307051	N9307059
Carbosieve™ SIII 60/80	N9307052	N9307060
Tenax™ GR 60/80	N9307053	N9307061
Tenax™ TA 60/80	N9307054	N9307062
Chromasorb™ 60/80	N9307055	N9307063
Carbopack™ and Carbosieve™ Carbopack™ B 60/80 Carbopack™ C 60/80 Carbosieve™ SIII 60/80	N9307056	N9307064
Carbotrap™ C/B 20/40		N9307065
NIOSH	N9307057	N9307066
XRO™-440	N9307120	
XRO™-640	N9307122	

Empty Sample Tubes without Caps

Description	Pkg.	Part No.
Stainless Steel	10	L4270128
Glass	10	L4071594
Stainless Steel	100	L4270129

Empty Sample Tubes with Plastic End Caps

Description	Pkg.	Part No.
Stainless Steel	10	M0413595
Glass Lined Stainless Steel	10	M0413597
Glass	10	M0413598

Soil Vapor Intrusion (SVI™) Tubes

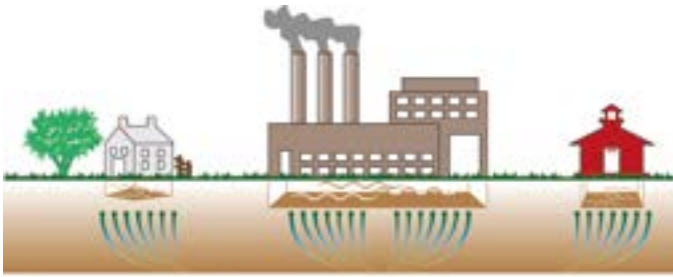

Soil vapor intrusion occurs when toxic compounds that are present in the air space in soil of a contaminated location have ways of entering a building, potentially creating a health risk. Our new multi-bed construction extends the hydrocarbon range past naphthalene while retaining the lighter components, enabling larger sample volumes, hence, enhancing detection limits. Has a unique design that meets the challenges and criteria of the EPA regulations for air monitoring.

Features and Benefits

- From chloromethane through diesel range hydrocarbons
- After the analysis, tubes are clean and ready for re-sampling reducing costs

Description	Part No.
Stainless Steel TD Tubes Conditioned	N9306277
Stainless Steel TD Tubes Un-Conditioned	N9306278

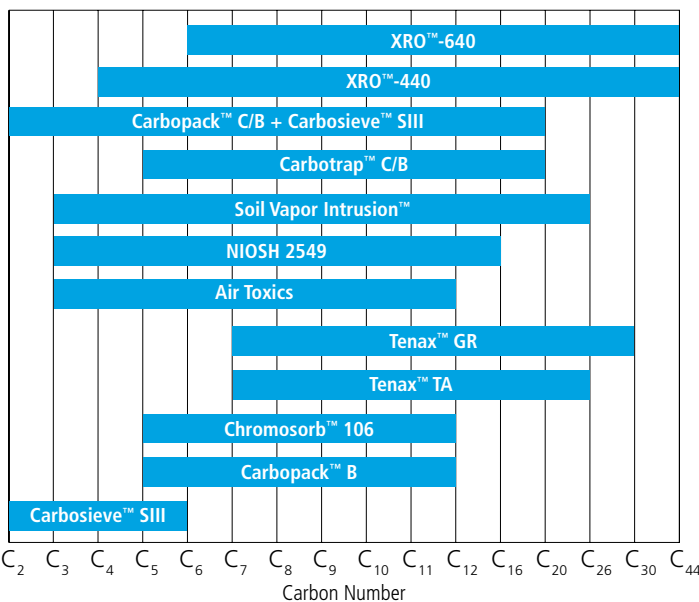

Selecting the right sorbent tube.

Conditioned Thermal Desorber Tubes

Stainless steel and glass sample tubes are available with a wide variety of packing materials from single to multi-bed. PerkinElmer Thermal Desorber tubes are printed with the packing material and an arrow, which points to the end of the tube where sample is drawn from, and also indicates the end that desorb vapors will exit.



Fully conditioned Thermal Desorber tubes

Each tube is etched with a unique serial number for ease of traceability and adsorbent identification. Stainless steel tubes may also be fitted with clips that accept adhesive labels for identification. Packed tubes are shipped with long-term brass storage caps and all tubes are thermally conditioned and tested for background and backpressure.

Packed Conditioned Sample Tubes, Brass Long-Term Storage End Caps (pkg. 10)

'NOT for Analytical test applications', use **N6200119** PTFE caps and O-rings. (pkg. 20).

The new and unique Extended Range Organics XRO™ 440 and 640 Tubes have been designed to accommodate a target component range from nC₄ to nC₄₄ and nC₆ to nC₄₄, respectively. They are suitable for methods such as TO-17 and EPA-325.

Description	Stainless Steel Part No.	Glass Part No.
Air Toxics	N9307001	N9307008
Carbopack™ B60/80	N9307002	N9307009
Carbosieve™ SIII 60/80	N9307003	N9307010
Tenax™ GR 60/80	N9307004	N9307011
PKI Tenax™ TA 60/80	N9309130	
Tenax™ TA 60/80	N9307005	N9307012
Chromasorb™ 60/80	N9307006	N9307013
Carbopack™ and Carbosieve™ Carbopack™ B 60/80 Carbopack™ C 60/80 Carbosieve™ SIII 60/80	N9307000	N9307007
Carbotrap™ C/B 20/40	N9307026	
NIOSH 2549	N9307038	N9307037
XRO™-440	N9307121	
XRO™-640	N9307123	
XRO™ Calibration Tubes	N9307124	

Arnel Analyzer Consumables

PerkinElmer offers a wide selection of superior quality products designed to work with your PerkinElmer instruments. Our precision designed products deliver the peace of mind that comes from knowing that you'll get the results you need.

Quick Reference Index

	Page
➤ Arnel Analyzers	126
➤ Arnel Analyzers Applications Highlights	134
➤ Arnel Sample Loops	131
➤ Arnel Service Spares Kit	130
➤ Replacement Column Sets for Standard Arnel Refinery Gas Analyzers	127
➤ Replacement Column Sets for Standard Arnel Natural Gas Analyzers	127
➤ Replacement Column Sets for Other Standard Arnel Analyzers	127-128
➤ Calibration Material	133
➤ Capillary Columns for Arnel Engineered Analyzers	126
➤ Fused Silica Adaptors	133
➤ Gas Sampling Valve Kits	131
➤ Liquid Sample Valves and Accessories	129
➤ Permeation Tubes	132
➤ Sample Loops	131
➤ Sampling and Installation Parts	132
➤ SCD Maintenance	132
➤ Standoffs	131
➤ Methanizers	133
➤ Nuts and Ferrules	132
➤ Union and Tees	133
➤ Valves	129

Valves

A majority of the Arnel configurations utilize two different types of valves. Most can be categorized as external volume injectors while the other type is an internal sample injector.



➤ [VIEW PAGE](#)

Sample Loops

A range of stainless steel sample loops are available for varying applications; with injection volumes from 100 µL to 5 mL and options for 6, 8 or 10 port valves. The Arnel sample loops are set apart from standard stainless steel loops due to the materials that are used in their manufacture.



➤ [VIEW PAGE](#)

Capillary Columns for Arnel Engineered Analyzers

PerkinElmer capillary column replacement sets are available for a wide range of applications. From refinery and natural gas to specific and also including many standard methods, ASTM and trace gases for example.

➤ [VIEW PAGE](#)

Calibration Materials

Our calibration gas blends were formulated to be used exclusively in our Refinery and Natural Gas Analyzers. These are the same test gases that are used in the verification and validation processes that take place at our factory.



➤ [VIEW PAGE](#)

Arnel Analyzers

The measurement of semivolatile and volatile compounds in petrochemical feeds, processes and products can be easily accomplished with turnkey analyzers and systems designed to meet accepted standard methods. PerkinElmer's Arnel™ analyzers offer a market leading customized chromatography solution. We provide, install, and support a full range of guaranteed analyzers, systems and accessories.

Arnel

We have an APP for that!

The Arnel Group within PerkinElmer Gas Chromatography is responsible for providing complete engineered solutions for a wide array of often encountered analytical problems. Do you have the need for a custom solution to perform ASTM or other regulated methods in your lab? Some of the types of analyzers Arnel has supplied are found in the list of categories shown here:

Natural Gas/NGL

Condensates

LPG

Refinery/Light Hydrocarbon Gas

Olefins

Aromatics

Oxygenates

Industrial Solvents

Naphthas

Gasoline

Distillates

Lube Oils/Waxes

Crude Oils

Asphalt

Bulk Gases

Trace Gases

TOGA

SCD

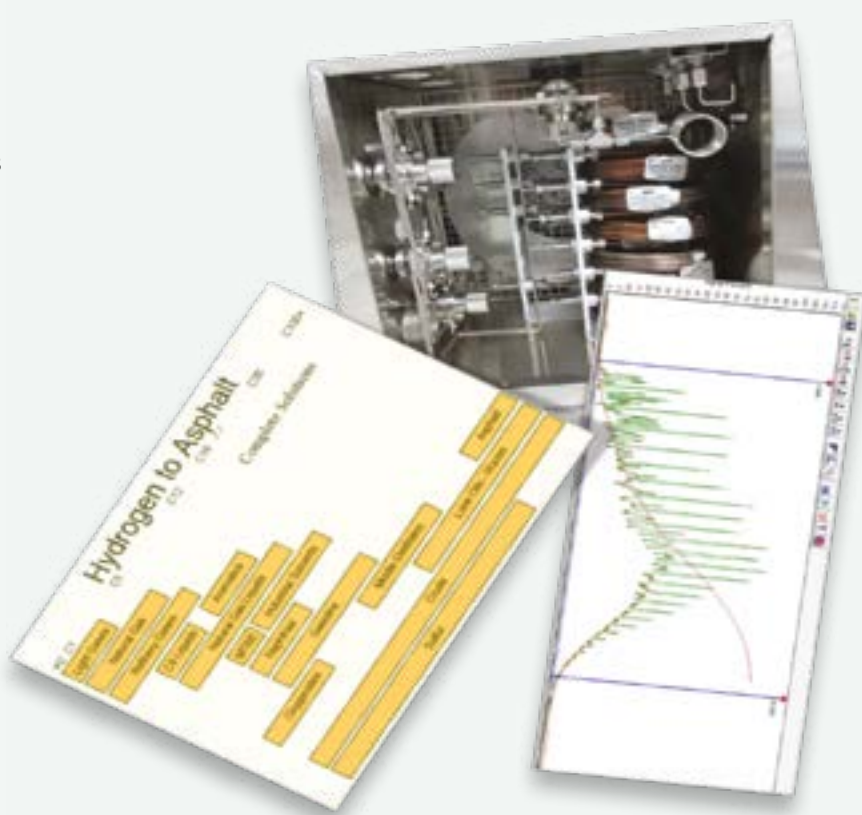

Capillary Columns for Arnel Engineered Analyzers

Why would you compromise your gas chromatography by accepting cheap substitutes when replacing the columns in your Arnel Analyzer? Use only genuine PerkinElmer column sets as replacements to meet your specific chromatographic needs.

Don't see what you need?

Please contact your local PerkinElmer sales representative for replacement column sets for Custom Engineered Arnel Analyzers or for more information about our Arnel Engineered Solutions Analyzers.

Replacement Column Sets for Standard Arnel Refinery Gas Analyzers

Model	Description	Part No.
1015	Replacement Column Set for the RGA Model 1015 – Two channel RGA; Hydrocarbons (FID) and Light Gases (TCD)	N6107032
1115	Replacement Column Set for the Arnel RGA – Three channel RGA; Hydrocarbons (FID), Light Gases (TCD) and He/H ₂ channel (TCD)	N6107033
1116	Replacement Column Set for the RGA Model 1116 – Three channel RGA; Hydrocarbons (TCD) and Light Gases (TCD) + He/H ₂ channel (TCD)	N6107033
1157	Replacement Column Set for the RGA Model 1157 – Three channel RGA; Hydrocarbons (FID), Light Gases (TCD) and He/H ₂ channel (TCD)	N6107033
1215	Replacement Column Set for the RGA Model 1215 – Two channel RGA; Hydrocarbons (FID) and Light Gases (TCD) + LSV	N6107032
1315	Replacement Column Set for the RGA Model 1315 – Three channel RGA; Hydrocarbons (FID) and Light Gases (TCD) and He/H ₂ channel (TCD) + LSV	N6107033
1317	Replacement Column Set for the RGA Model 1317 – Three channel RGA; Hydrocarbons (FID) and Light Gases (TCD) and He/H ₂ channel (TCD) + LSV	N6107033
1515	Replacement Column Set for the RGA Model 1515 – Three channel RGA; Hydrocarbons (FID) and Light Gases (TCD) and He/H ₂ channel (TCD) + LSV	N6107033
Other		
Hydrocarbon channel	Replacement column set for the hydrocarbon channel in any RGA model	NR00HC15

Replacement Column Sets for Standard Arnel Natural Gas Analyzers

Model	Description	Part No.
2000	Replacement Column Set for the NGA Model 2000 – Detection of hydrocarbons	N6107040
2001	Replacement Column Set for the NGA Model 2001 – Detection of hydrocarbons, CO ₂ , air and H ₂ S	N6107040
2002	Replacement Column Set for the NGA Model 2002 – Separation of air and methane	N6107048
2003	Replacement Column Set for the NGA Model 2003 – Separation of O ₂ and N ₂	N6107052
2006	Replacement Column Set for the NGA Model 2006 – Detection of hydrocarbons, CO ₂ , air and H ₂ S	N6107056
2008	Replacement Column Set for the NGA Model 2008 – Separation of O ₂ and N ₂ (with capillary channel)	N6107060
2101	Replacement Column Set for the NGA Model 2101 – Detection of hydrocarbons, CO ₂ , air, H ₂ S and He/H ₂	N6107041
2103	Replacement Column Set for the NGA Model 2103 – Separation of O ₂ and N ₂ + He/H ₂ channel	N6107053
2106	Replacement Column Set for the NGA Model 2106 – Detection of hydrocarbons, CO ₂ , air, H ₂ S and He/H ₂	N6107057
2108	Replacement Column Set for the NGA Model 2108 – Separation of O ₂ , N ₂ and He/H ₂ (with capillary channel)	N6107061
2201	Replacement Column Set for the NGA Model 2201 – Detection of hydrocarbons, CO ₂ , air and H ₂ S + LSV	N6107040
2203	Replacement Column Set for the NGA Model 2203 – Separation of O ₂ and N ₂ + LSV	N6107052
2206	Replacement Column Set for the NGA Model 2206 – Detection of hydrocarbons, CO ₂ , air, and H ₂ S + LSV	N6107056
2208	Replacement Column Set for the NGA Model 2208 – Separation of O ₂ and N ₂ (with capillary channel) + LSV	N6107060
2301	Replacement Column Set for the NGA Model 2301 – Detection of hydrocarbons, CO ₂ , air, H ₂ S and He/H ₂ + LSV	N6107041
2303	Replacement Column Set for the NGA Model 2303 – Separation of O ₂ and N ₂ + He/H ₂ channel + LSV	N6107053
2306	Replacement Column Set for the NGA Model 2306 – Detection of hydrocarbons, CO ₂ , air, H ₂ S and He/H ₂ + LSV	N6107057
2406	Replacement Column Set for the NGA Model 2406 – Detection of hydrocarbons, CO ₂ , air, and H ₂ S + LSV	N6107056
2501	Replacement Column Set for the NGA Model 2501 – Detection of hydrocarbons with sulfur channel	NR002500
2503	Replacement Column Set for the NGA Model 2503 – Detection of hydrocarbons with sulfur channel	NR002503

Replacement Column Sets for Other Standard Arnel Analyzers

Model	Description	Part No.
3023	Sim Dis Capillary Column, COL C 10 x 0.53 x 2.65 MXT-2887	NR213000
3023	Sim Dis Capillary Column, COL C 5 x 0.53 x 0.10 MXT-1 HT	NR213314
4001	Replacement Column Set for the Models 4001 and 4002 – ASTM 4815	N6107070
4002	Replacement Column Set for the Models 4001 and 4002 – ASTM 4815	N6107070
4003	Replacement Column Set for the Model 4003 – TOGA	N6107072

Note: Column sets are sold only as spares with an order, or as replacements to installed analyzers.

ARNEL ANALYZER CONSUMABLES

Replacement Column Sets

Model	Description	Part No.
4004	Replacement Column Set for the Model 4004 – ASTM 4815 and ASTM 5580	N6107073
4005	Replacement Column Set for the Model 4005 – ASTM 5580	N6107073
4012	Replacement Column Set for Models 4012 – ASTM 3606 + ASTM 4815	N6107216
4013	Replacement Column Set for the Models 4013 and 4014 – ASTM 3606	N6107218
4014	Replacement Column Set for the Models 4013 and 4014 – ASTM 3606	N6107218
4015	Replacement Column Set for the Model 4015 – ASTM 3606, 5580 + 4815	N6107216
4016	Replacement Column Set for the Model 4016 – Light and combustion gas	N6107221
4017	Replacement Column Set for the Model 4017 – Light and combustion gas	N6107222
4019	Replacement Column Set for the Model 4019 – Light and combustion gas	N6107224
4020	Replacement Column Set for the Model 4020 – Impurities in chlorine	N6107075
4021	Replacement Column Set for the Model 4021 – Trace CO, CH ₄ and CO ₂	N6107225
4022	Replacement Column Set for the Model 4022 – CO, CO ₂ in propylene	N6107076
4024	Replacement Column Set for the Model 4024 – UOP 603	N6107226
4025	Replacement Column Set for the Model 4025 – Trace sulfur in gases by GSV	N6107208
4027	Replacement Column Set for the Model 4027 – Trace sulfur in gases by syringe	N6107208
4028	Replacement Column Set for the Model 4028 – Trace sulfur in gases by GSV and LSV	N6107241
4029	Replacement Column Set for the Model 4029 – Trace sulfur in gases by GSV and syringe	N6107241
4030	Replacement Column Set for the Model 4030 – Trace sulfur in gases by GSV + PID	NR004030
4031	Replacement Column Set for the Model 4031 – Trace sulfur in gases by GSV + FID	NR004031
4032	Replacement Column Set for the Model 4032 – Full range H ₂	N6107227
4033	Replacement Column Set for the Model 4033 – Full range O ₂ and N ₂	N6107228
4034	Replacement Column Set for the Model 4034 – Full range H ₂ , O ₂ and N ₂	N6107229
4035	Replacement Column Set for the Model 4035 – Light hydrocarbons by GSV	N6107230
4036	Replacement Column Set for the Model 4036 – Light hydrocarbons by LSV	N6107230
4037-1	Replacement Column Set for the Model 4037 – LPG light hydrocarbons by GSV and LSV with one column	N6107230
4037-2	Replacement Column Set for the Model 4037 – LPG light hydrocarbons by GSV and LSV with two columns	N6107232
4038	Replacement Column Set for the Model 4038 – Trace sulfur in gases by GSV + PID and FID	NR004038
4040	Replacement Column Set for the Model 4040 – Trace light gases by DID	NR004040
4041	Replacement Column Set for the Model 4041 – Trace light gases by PID	NR004041
4043	Replacement Column Set for the Model 4043 – Trace gases by PID and DID	NR004043
4044	Replacement Column Set for the Model 4044 – Trace gases by DID and FID	NR004044
4045	Replacement Column Set for the Model 4045 – Trace gases by FID and PID	NR004045
4046	Replacement Column Set for the Model 4046 – Trace gases by DID, FID and PID	NR004046
4050	Replacement Column Set for the Model 4050 – Detailed Hydrocarbon Analyzer	N6107220
4080	Replacement Column Set for the Model 4080 – Oxygenates and Aromatics in Gasoline	N6107233
4083	Replacement Column Set for the Model 4083 – ASTM 2504	NR004083
4086	Replacement Column Set for the Model 4086 – Analysis of Trace Methanol and MTBE in Light Hydrocarbon Gases	NR004086
4087	Replacement Column Set for the Model 4087 – Transformer Oil Gases using ASTM 3612 Headspace Method C	NR004087
4227	Replacement Column Set for the Model 4227 – Trace sulfur in gases by syringe + LSV	N6107241
4425	Replacement Column Set for the Model 4425 – Trace sulfur in gases by GSV with permeation chamber	N6107208
4428	Replacement Column Set for the Model 4428 – Trace sulfur in gases by GSV + LSV with permeation chamber	N6107241
4429	Replacement Column Set for the Model 4429 – Trace sulfur in gases by GSV and syringe with permeation chamber	N6107241
4430	Replacement Column Set for the Model 4430 – Trace sulfur in gases by GSV + PID with permeation chamber	NR004030
4431	Replacement Column Set for the Model 4431 – Trace sulfur in gases by GSV + FID with permeation chamber	NR004031
4438	Replacement Column Set for the Model 4438 – Trace sulfur in gases by GSV + PID and FID with permeation chamber	NR004038
4629	Replacement Column Set for the Model 4629 – Trace sulfur in gases by GSV and syringe + LSV with permeation chamber	N6107241
51XX	Replacement Column Set for the 51XX PET Bottle Analyzer	NR005100
52XX	Replacement Column Set for the 52XX Workspace Air Monitoring System	NR005200

Note: Column sets are sold only as spares with an order, or as replacements to installed analyzers.

Valves

A majority of the Arnel configurations utilize two different types of valves. Most can be categorized as external volume injectors while the other type is an internal sample injector. The injection volume of an internal sample injector valve is determined by the size of etching on the rotor of the valve. External volume sample size is determined by a sample loop outside the valve. External valves are used primarily for sample injection and/or switching applications. A valve used for just switching requires another valve for sample injection. Valves include nuts and ferrules, but not loops.



Ports	Part No.	Max Temperature (C°)	Rotation	Max Pressure (psi)	Fitting (in.)	Material	Rotor Type	Replacement Rotor Part No.
4 Port	N9302809	175	90°	400	1/16	Stainless Steel	P	
	N9302813	350	90°	300	1/16	Stainless Steel	T	
	N9302817	330	90°	300	1/8	Stainless Steel	T	
6 Port	N9302810	175	60	400	1/16	Stainless Steel	P	N9302897
	N9302814	350	60	300	1/16	Stainless Steel	T	N9302901
	N9302818	330	60	300	1/8	Stainless Steel	T	N9302905
8 Port	N9302811	175	45	400	1/16	Stainless Steel	P	
	N9302815	350	45	300	1/16	Stainless Steel	T	
10 Port	N9302812	175	36	400	1/16	Stainless Steel	P	N9302899
	N9302816	350	36	300	1/16	Stainless Steel	T	N9302903
	N9302820*	330	36	300	1/8	Stainless Steel	T	

*(P) PTFE-Carbon Composite(T) Polyimide-PTFE-Carbon Composite.

Liquid Sample Valves

Arnel stainless steel liquid sample valves come with a complete valve, close-mount kit, actuator and valve mounting bracket.

Ports	Part No.	Volume (µL)	Rotation	Max Pressure (psi)	Fitting (in.)	Material	Max Temperature	Replacement Rotor Part No.
4	NR810070	0.2 and 0.5	90	1000	1/16	Stainless Steel	75 °C	NR510291
4	N9302800	0.06	90	500	1/16	Stainless Steel	75 °C	
4	N9302802	0.2	90	500	1/16	Stainless Steel	75 °C	N9302889
4	N9302803	0.5	90	500	1/16	Stainless Steel	75 °C	N9302890
4	N6107742	1	90	500	1/16	Stainless Steel	75 °C	NR510337

Liquid Sample Valve Accessories

Description	Part No.
2 Micron In-line Filter – 1/8 in. Stainless Steel – Used on 'Sample In' line	N6107085
Check Valve (10 psi) – Brass – Used on 'Sample Out' Line	N6107086

Arnel Service Spares Kit

Our Arnel GC systems utilize both standard GC parts, and parts specific to the Arnel configuration. To facilitate fast, easy service and maintenance a spare kit is available containing essential hardware items. Individual part numbers are also listed to streamline re-ordering.

Description	Part No.
Arnel Service Spares Kit	N6100726

Kit contents



Description	Qty	Part No.
RDCR – Union 1/8" TBG 1/16" TBG SST	2	09903102
Nut – TBG Hex 0.062 TBG SST	2	09903157
Ferrule – Front 1/16" SST	2	09903158
Ferrule – Back 1/16" SST	2	09903159
Union – 1/8" TBG SST	2	09903415
Cap – Tube End 0.125 TBG BRS	1	09903452
Valve – Toggle Brass	1	09903558
Reducer Union 1/4" – 1/16"	2	09903928
30 ml Plastic Pump Priming SYR 1 PC	1	09904849
Ferrule – TBG 1/8" Vespel	1	09920133
RDCR – 1/16" TBG 1/32" Port SST	3	09920163
Ferrule – TBG 1/16" Vespel	4	09920301
List, Part Numbers	1	09931072
Contact – Socket Crimp 26-22 AWG Gold	16	09997099
Connector – HSG 2 POS 0.100 CTR RCPT	8	09997403
Case, Akro-Mills Portable Organizer	1	N6105400
Nut – 1/16" STD 1/4" Hex X 0.425	8	N9302832
Nut – 1/8" STD 3/8" Hex X 0.575	8	N9302833
Ferrule – 1/16" 300 Series 0.145 OD	10	N9302835
Ferrule – 1/8" 300 Series 0.250 OD	10	N9302836
Union – 1/16" 1/32" B 0.010 Reducing	4	N9302838
Union – 1/16" Bore 0.029 1/4" Hex	6	N9302839
Fused Silica Adapter – 1/16" 0.5 mm OD	4	N9302846
Fused Silica Adapter – 1/16" 0.8 mm OD	4	N9302847
Union – 2U Screen 1/16" Filter	1	N9302879
Rotor P 6 PT VLV	1	N9302897
Rotor P 10 PT VLV	1	N9302899



Description	Qty	Part No.
Magnetic Rotor Removal Tool	1	N9302914
Reducer – 1/8" 1/16" B 0.029 External	4	N9302917
Plug – ZP1 1/16"	1	N9302918
Wrench 3/16"	1	N9306258
Union Tee 1/16" SS	1	NR410042
Bulkhead Reducing Union 1/8" – 1/16" Valco	2	NR410110
FRL 1/16" HC Valco	6	NR410190
FRL Polyimide 1/32" x 0.8	6	NR410229
Tee 1/16" W/ 0.030 Bore Valco	2	NR410245
Rotor P 8 PT VLV	1	NR510417
FRL Vespel 1/32" x 0.5 mm	6	NR510486
Tubing Nickel 1/16" x 0.030 (10 FT)	1	NR710025-10
SS Tubing SF Treat 1/16" x 0.030 x 10 ft	1	NR710079-10
Syringe Needle	1	NR9000050

Standoffs

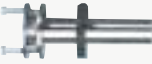
A standoff supports both the actuator and the valve. The standoff places the valve at the specific distance from the actuator. A 4 1/8 in. standoff is recommended for mounting valves in PerkinElmer GC ovens. Standoff and actuator sold separately.

Length	Part No.
2 in. 	N9302909
3 1/4 in. 	N9302910
4 1/8 in. 	N9302911
6 in. 	N9302912
Description	Part No.
Close Mount Hardware Kit	N9302908

Sample Loops



Volume	Size (in.)	6 Port Part No.	8 Port Part No.	10 Port Part No.
100 µL	1/16	N9302851		N9302857
100 µL	1/8	N9302860		N9302866
250 µL	1/16	N9302852	N9302855	N9302858
250 µL	1/8			N9302867
500 µL	1/16	N9302853		N9302859
1 mL	1/16	N9302950	N9302953	N9302956
1 mL	1/8			N9302965
2 mL	1/16	N9302951	N9302954	N9302957
5 mL	1/16	N9302952		N9302958
5 mL	1/8	N9302961		

1/8 in. fitting loop for valves with 0.030 in. standard port diameter.
1/16 in. fitting loop for valves with 0.016 in. standard port diameter.

Arnel Sample Loops

The Arnel sample loops are set apart from standard stainless steel loops due to the materials that are used in their manufacture. Arnel offers loops made of nickel and Sulfinert treated stainless steel tubing.

Description	Part No.
0.1 cc Nickel	NR950001
0.125 cc Nickel	NR950007
0.2 cc Nickel	NR950002
0.25 cc Nickel	NR950003
0.5 cc Nickel	NR950004
1.0 cc Nickel	NR950005
2.0 cc Nickel	NR950006
0.07 cc Sulfinert Treated	NRSLSF0.07
0.1 cc Sulfinert Treated	NR950008
0.125 cc Sulfinert Treated	NR950014
0.2 cc Sulfinert Treated	NR950009
0.25 cc Sulfinert Treated	NR950010
0.5 cc Sulfinert Treated	NR950011
1.0 cc Sulfinert Treated	NR950012
2.0 cc Sulfinert Treated	NR950013
3.0 cc Sulfinert Treated	NR950015

Gas Sampling Valve Kits



Description	Part No.
10 PT GSV Kit External Mounted	N6100563
Kit for mounting a gas sampling valve outside of the main oven Kit contains: One each of: 10 port SS valve with P rotor, Closemount hardware, 36 deg Actuator, Angle Bracket, Mounting Kit, Solenoid Kit, 100 µL Sample Loop, 250 µL Sample Loop, 1 ml Sample loop	
10 PT GSV Kit Oven Mounted	N6100564
Kit for mounting a gas sampling valve inside the main oven Kit contains: One each of: 10 port SS valve with P rotor, 4" Standoff, 36 deg Actuator, Mounting Kit, Solenoid Kit, 100 µL Sample Loop, 250 µL Sample Loop, 1 ml Sample loop	

Permeation Tubes

Full NIST traceability using established EPA and ASTM protocols by using the appropriate combination of permeation devices. The permeation tubes are certified to be permeating at a certain weight and threshold (~+/- 2%). Uncertified tubes have an estimated rate and a very large threshold, up to +/- 25%.



Description	Part No.
Dimethylsulfide Permeation Tube (certified)	N6107361
Ethanol Permeation Tube (certified)	N6107362
Benzene Permeation Tube (certified)	N6107363

SCD Maintenance

The SCD parts listed are to support the Agilent 355 Dual Plasma Sulfur Chemiluminescence Detector (SCD).

Description	Part No.
12 Month Maintenance Kit for Dual Plasma SCD	N6107237
Ceramic Tube Package for the Dual Plasma SCD Burner	NR310502
12 Month Maintenance Kit for Single Plasma SCD	N6107209
Ceramic Tube Package for the Single Plasma SCD Burner	N6107313

These kits support the PAC SeNse® NCD and SCD detectors.

Description	Part No.
SeNse Consumable Sulfur Kit	NR333003
SeNse Spare Kit for the Consumable Kit	NR333004

Sampling and Installation Parts

Description	Part No.
Sampling Accessories	
Sampling Kit – Arnel GSV; Connects to 1/16 in. sample inlet line for easy gas sample introduction – Content of kit: 3 – BD 30 mL Luer Lock Syringes, 1 6-pack of needles, 1 port adapter, 10 septa	N6100724
Installation Hardware	
Tee 1/8 in. brass	09903170
Cross 1/8 in. brass	N9301259
Pre-cleaned copper tubing, 1/8 in. OD x 50 ft.	N9300077
VCR Gasket (PDID Channel)	
Nickel Face Seal VCR Gasket – For use with PDID channel 'Sample In' line connections	NR410252N

Nuts and Ferrules

Description	Part No.
Nuts	
Nut 1/16 Stainless Steel – For use with Valco valves and fittings	09903980
Nut for 1/8 in. Tube Fitting – Stainless Steel – Used to make connections at FID, TCD, FPD, PID	09903453
Nut 1/16 in. Stainless Steel – Used to make connections at CAP, PSS and POC injectors	09903392
Nut 1/8 in. – Stainless Steel – For use with Valco Valves and Fittings	N9302833
Ferrules	
FRL 1/16 in. 0.8 mm ID (pkg. 10) – For use with capillary columns 0.18 – 0.53 mm ID and nut 09903392	09920141
FRL 1/16 in. 0.5 mm ID (pkg. 10) – For use with capillary columns 0.18 – 0.32 mm ID and nut 09903392	09903700
FRL 1/32 in. 0.8 mm ID Polyamide – For use with 1/32 in. unions and fittings	NR410229
FRL 1/32 in. 0.8 mm ID Polyamide – For use with 1/32 in. unions and fittings (pkg. 5)	NR410229-5
FRL 1/8 in. Graphite 0.5 mm ID – For use with capillary columns 0.18 – 0.32 mm ID and nut 09903453	NR510002
Ferrule Set 1/16 in. Stainless Steel (pkg. 10) (1 front ferrule/1 back ferrule)	NR410049-10
FRL 1/16 in. Stainless Steel – For use with Valco Valves and Fittings	09903891
Ferrule 1/8 in. Graphite/Vespel – For use with packed columns union NR410110	09920133
Ferrule Reducing 1/8 in. – 1/16 in. ID Graphite/Vespel	09920301
FRL 1/32 in. 0.5 mm ID Polyamide – For use with 1/32 in. unions and fittings	NR510486
FRL 1/32 in. 0.5 mm ID Polyamide – For use with 1/32 in. unions and fittings (pkg. 5)	NR510486-5

Fused Silica Adaptors

These adaptors allow connection of fused silica to unions, valves and ports.

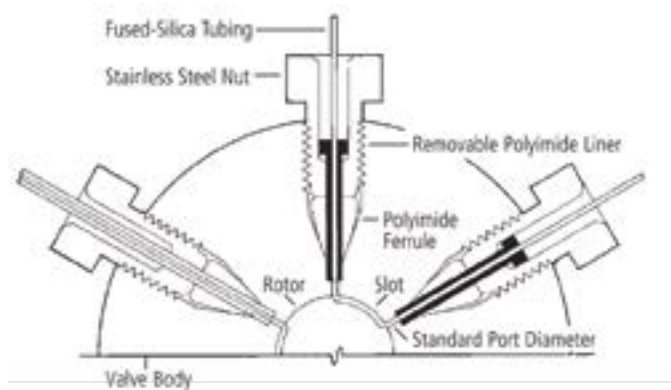

Description	Part No.
Fused Silica Adapter 1/16 in. for 0.2 to 0.4 mm ID tube	NR510233
Fused Silica Adapter 1/16 in. for 0.4 to 0.5 mm ID tube	NR9302846
Fused Silica Adapter 1/16 in. for 0.5 to 0.8 mm ID tube	NR510030

Union and Tees

Description	Part No.
Union 1/16 x 0.75 mm ID bore – Stainless Steel	NR9302839
Union 1/16 x 0.75 mm ID bore – Stainless Steel Silco treated	NR410175
Reducing union 1/16 in. to 1/32 in. – Stainless Steel – For use with 1/16 in. Valco valves and fittings	09920163
Tee – 1/16 in. x 0.75 mm Bore – Stainless Steel	NR410245
Tee – 1/32 in. Low dead volume connector for capillary tubing/columns	NR410262
Bulkhead Reducing union 1/8 in. to 1/16 in. – Stainless Steel. For use with packed columns in rack	NR410110

Methanizers

Description	Part No.
Methanizers	
Replacement Methanizer Assembly for Models containing Arnel Methanizers. For 115 V operation	N6107080
Replacement Methanizer Assembly for Models containing Arnel Methanizers. For 230 V operation	N6107081

Calibration Material

Our calibration gas blends were formulated to be used exclusively in our Refinery and Natural Gas Analyzers. These are the same test gases that are used in the verification and validation processes that take place at our factory. Please contact your local PerkinElmer sales representative for more information about the composition of the gas blends.



Description	Part No.
RGA Calibration Blend with Syringe Adapter	N6107198
RGA Calibration Blend without Adapter	N6107199
NGA Calibration Blend with Syringe Adapter	N6107200
NGA Calibration Blend without Adapter	N6107201
ASTM D7423 Oxygenates Calibration Kit & Check Standard, 5x2 mL & 1x2 mL	N9300285
ASTM D5580 Calibration Kit & Valve Timing Solution with ISTD, 1x10 mL & 5x1 mL	N9300286
ASTM D3606 Benzene in Gasoline Calibration Kit & Check Standard, 7x2 mL & 1x1 mL	N9300287
ASTM D3606 Benzene in Gasoline with Ethanol Calibration Kit & Check Standard, 7x2 mL & 1x1 mL	N9300288
ASTM D4815 Oxygenates in Gasoline Calibration Kit & Retention Time Mixture, 11x2 mL & 1x1 mL	N9300289
Reference gas oil 5010 1% in carbon disulfide, 5x2 mL	N9308755
Simulated Distillation Reference Material for C32-C60, 1 mL	N9308793
Simulated Distillation Reference Material for C5-C120, 1 mL	N9308794
Reference Gas Oil No. 2 for ASTM D2887, 10x1 mL	N9308795
Sulfur Standard for ASTM D5623: Multi-component standard containing 22 sulfur species @ 50 µg/g (as Component) in Base Fuel, 2x2 mL	N9308796
PIANO (DHA) Standard ASTM Methods D5134, D6296, D6729, D6730 and D6733, 10x1 mL	N9308798
ASTM D2887 Calibration Mix 1 Wt% in Carbon Disulfide, 1 mL	N9308799

Arnel Analyzer Application Highlights

Methanol in Crude Oils According to ASTM D7059-04 Using a Clarus GC with S-Swafer Micro-Channel Flow Technology.

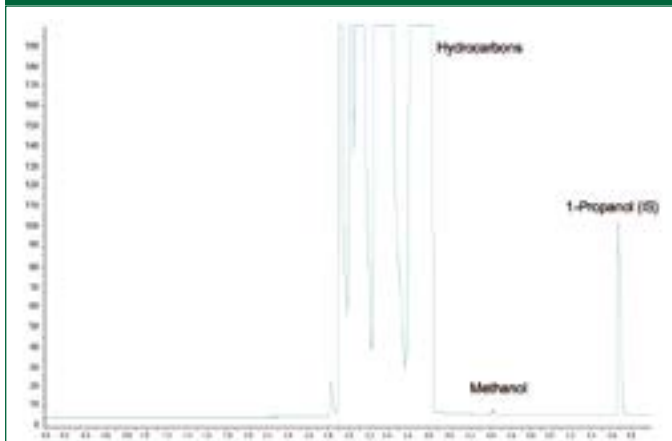

Column: Elite-1 30 m x 0.53 mm x 5.0 μm Part No. **N9316052**
S-Swafer Part No. **N6520272**

The Determination of C2 to C5 Hydrocarbons in Finished Gasolines using the PerkinElmer Clarus 680 GC with Swafer Technology.

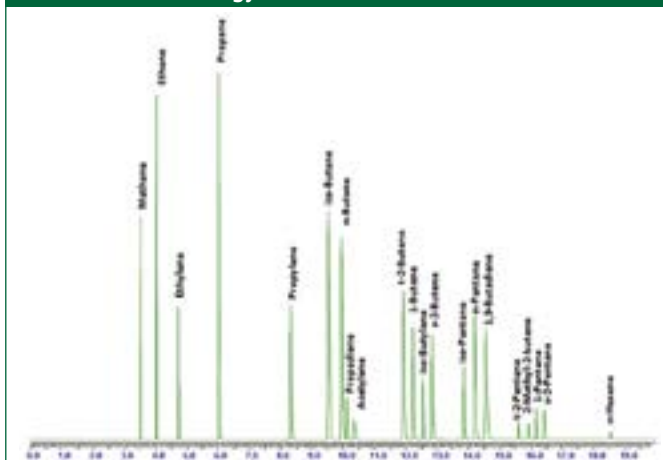

Column: Elite-WAX, 30 m x 0.25 mm x 0.5 μm Part No. **N9316404**
and Al_2O_3 PLOT/ Na_2SO_4 50 m x 0.32 mm Part No. **N6107777**
S-Swafer Part No. **N6520272**

The Determination of Benzene and Toluene in Finished Gasolines Containing Ethanol Using the PerkinElmer Clarus GC with Swafer Technology.

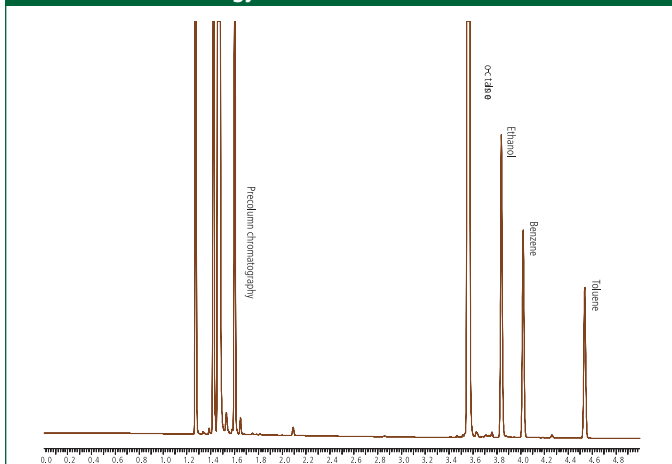

Column: Elite-1, 30 m x 0.25 mm x 0.25 μm Part No. **N9316010**
and COL-Elite-TCEP 60 m 0.25 mm 0.40 μm Part No. **N6107760**
S-Swafer Part No. **N6520272**

Fast Simulated Distillation Analysis by Modified ASTM[®] D2887, D6352 and D7169.

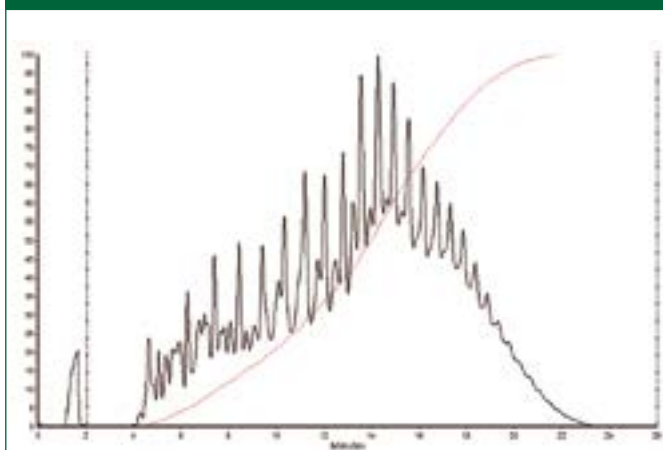

Column: 10 m x 0.53 mm x 2.65 μm MXT-2887 Part No. **NR213000**

Torion Accessories & Consumables

PerkinElmer offers a wide selection of superior quality products designed to work with your PerkinElmer instruments. Our precision designed products deliver the peace of mind that comes from knowing that you'll get the results you need.

Quick Reference Index

	Page
▶ Accessory Kits	139
▶ Battery Options	140
▶ Calion Chemical Standards	140
▶ Carrier Gas Consumables	139
▶ Conventional Trap Sample Collection Tubes	138
▶ Custodion Needle Trap Samplers	138
▶ Custodion SPME Samplers	138
▶ Liners, Seals and Filaments	140
▶ Needle Trap Kits	139
▶ Sample Prep Station (SPS-3)	137
▶ Sampling Accessories	138
▶ SPS-3 Accessories	139
▶ SPS-3 Consumables	139
▶ Spare Parts	140
▶ Starter Kits	138
▶ Torion T-9 Portable GC/MS	136

Custodion SPME Syringes

The Custodion® SPME (Solid Phase Microextraction) syringes useful for sampling and identification of a wide range of volatiles and semi-volatile compounds while in the field; used conjunction with the Torion T-9 portable system.



▶ [VIEW PAGE](#)

Custodion Needle Trap – Basic Kit

Our Custodion needle trap kits enable users to collect air samples in the field, adsorbing analytes directly onto our novel Custodion needle trap devices.



▶ [VIEW PAGE](#)

Calion Chemical Standards

Calion standards are premixed and adsorbed into a solid phase. These standards are ideal for in-field use because they contain no liquids.



▶ [VIEW PAGE](#)

Merlin Seal

The Merlin Microseal is an alternative to the conventional silicone rubber septa. Its unique design is ideal to use with the Custodion SPME and Needle Trap.



▶ [VIEW PAGE](#)

Torian T-9 portable GC/MS

PerkinElmer's Torion® T-9 is a portable GC/MS integrating a high speed Low Thermal Mass (LTM) capillary GC with a miniaturized toroidal ion trap mass spectrometer (TMS). It is designed to be carried in the field and is ideal for rapid screening of chemicals such as environmental volatiles and semi-volatiles (VOCs/SVOCs), explosives, chemical threats, and hazardous substances. The Torion T-9 family includes accessories for sampling air, water and soil.



Volatile organic compound screening in soil using SPME-GC/MS.

- | | |
|--------------------------------|---------------------------------|
| 1. Trichlorofluoromethane | 20. Chlorobenzene |
| 2. 1,1-Dichloroethylene | 21. 1,1,1,2-Tetrachloroethane |
| 3. Dichloromethane | 22. Ethylbenzene |
| 4. MTBE | 23. Xylene |
| 5. 1,2-Dichloroethylene (Z) | 24. Bromoform |
| 6. Chloroform | 25. Styrene |
| 7. 1,1-Trichloroethane | 26. 1,1,2,2-Tetrachloroethane |
| 8. 1,2-Dichloroethane | 27. Isopropylbenzene |
| 9. Carbon Tetrachloride | 28. Bromobenzene |
| 10. Benzene | 29. 1,2,3-Trichloropropane |
| 11. 2-Butanone | 30. 1,3,5-Trimethylbenzene |
| 12. Trichloroethylene | 31. 1,2,4-Trimethylbenzene |
| 13. Bromodichloromethane | 32. 1,3-Dichlorobenzene |
| 14. 1,3-Dichloro-1-propane (Z) | 33. 1,4-Dichlorobenzene |
| 15. 1,3-Dichloro-1-propane (E) | 34. 1,2-Dichlorobenzene |
| 16. Toluene | 35. 1,2-Dibromo-3-chloropropane |
| 17. 1,1,2-Trichloroethane | 36. 1,2,4-Trichlorobenzene |
| 18. 4-Methyl-2-pentanone | 37. Naphthalene |
| 19. Trachloroethylene | |

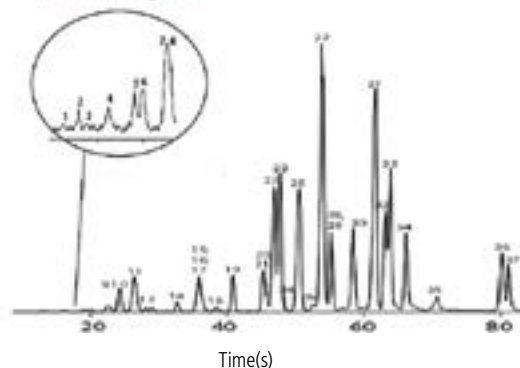

SPME Phase: Divinylbenzene/Polydimethylsiloxane (DVB/PDMS, 65 µm)

Rapid identification of illicit drug substances using thermal desorption coupled with a portable toroidal trap GC/MS system.

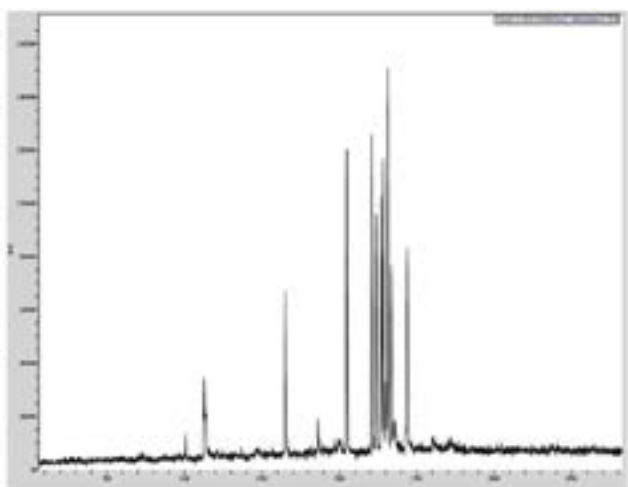

SPME Phase: Polydimethylsiloxane/divinylbenzene/carboxen (PDMS/DVB/CAR)

Method development for identification of adulterated spirits using field portable GC/MS.

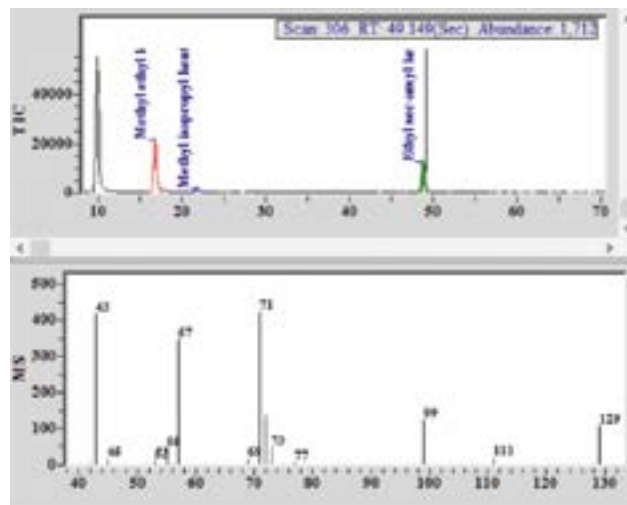

SPME Phase: Divinylbenzene/Polydimethylsiloxane (DVB/PDMS, 65 µm)

Sample Prep Station (SPS-3) for Rapid Field Sampling

The SPS-3 expands sampling capabilities of the Torion T-9 GC/MS with a few module options to fit your specific sample preparation needs. The optional desorption module (DM) extends the limits of detection of the T-9 by allowing samples to be collected using full size conventional thermal desorption tubes prior to analysis. The tube sample is then desorbed and concentrated onto a needle trap for injection into the T-9. The optional purge & trap module (PT) is used to concentrate water and soil samples onto a needle trap. Each SPS-3 comes with an internal standard module (IS) which adds the capability for semi-quantitative and quantitative analysis through addition of a fixed amount of 2 internal standard reference compounds onto a Custodion Needle Trap (NT).

SPS™-3 Sample Prep Station Dual DM w/IS

Description	Qty.	Part No.
SPS-3 with dual sample desorption module and an internal standard module.		NTSSPS30002
SPS-3 with Dual DM and IS Modules	1	
Ethernet LAN Cable	1	
Power Supply	1	
Transport Case with Foam Insert	1	
CT Handle Assembly	2	
CT Holder Assembly	2	
Seal/O-ring Kit for CT Handle Assembly	2	
Seal/O-ring Kit for CT Holder Assembly	2	
Seal/O-ring Kit for IS Assembly	1	
Helium Quick Disconnect with 1/16" PEEK Tubing	1	
SPS-3 User Manual on USB Flash Drive	1	
SPS-3 Tool Kit	1	



SPS-3 Sample Prep Station DM and P&T w/IS

Description	Qty.	Part No.
SPS™-3 with a sample desorption module, purge & trap module and an internal standard module.		NTSSPS30003
SPS-3 with DM, P&T and IS Modules	1	
Ethernet LAN Cable	1	
Power Supply	1	
Transport Case with Foam Insert	1	
CT Handle Assembly	1	
CT Holder Assembly	1	
P&T Cap Assembly	1	
Seal/O-ring Kit for CT Handle Assembly	1	
Seal/O-ring Kit for CT Holder Assembly	1	
Seal/O-ring Kit for IS Assembly	1	
Seal/O-ring Kit for P&T Assembly	1	
Helium Quick Disconnect with 1/16" PEEK Tubing	1	
SPS-3 User Manual on USB Flash Drive	1	
SPS-3 Tool Kit	1	

SPS-3 Sample Prep Station Dual P&T w/IS

Description	Qty.	Part No.
SPS™-3 with dual purge & trap modules and an internal standard module.		NTSSPS30004
SPS-3 with Dual P&T and IS Modules	1	
Ethernet LAN Cable	1	
Power Supply	1	
Transport Case with Foam Insert	1	
P&T Cap Assembly	2	
Seal/O-ring Kit for P&T Assembly	2	
Seal/O-ring Kit for IS Assembly	2	
Helium Quick Disconnect with 1/16" PEEK Tubing	1	
SPS-3 User Manual on USB Flash Drive	1	
SPS-3 Tool Kit	1	

Starter Kits

Two different starter kits are available to provide everything you need to get up and running with ease.

Description	Qty.	Part No.
Torion T-9 Basic Package.		NTSST090505
BB-2590 Charger	1	09280440
Transcend 32 GB Class 10 SDHC/SDXC UHS-I	1	09400003
Merlin Seal 19 GA for SPME NT Injector	6	NTS25700012
SRN SPME 19G BT W/DVB/PDMS 3 Rep Fibers	1	NTSC19SN3B171
Filament Assembly for T-9	1	NTSS0070034
GC Injector Liner Deactivated Gasket	1	NTSS20000021CG
Spare Cable Kit for ION Trap	1	NTSST090012
ION Spare O-ring Kit Trap	1	NTSST090045
Spare Screws and Washer Kit	1	NTSST090047

Description	Qty.	Part No.
Torion T-9 Advanced Kit.		NTSST090506
BB-2590 Charger	1	09280440
Transcend 32 GB Class 10 SDHC/SDXC UHS-I	1	09400003
Merlin Seal 19 GA for SPME NT Injector	12	NTS25700012
SRN SPME 19G BT W/DVB/PDMS 3 Rep Fibers	2	NTSC19SN3B171
Filament Assembly for T-9	1	NTSS0070034
GC Injector Liner Deactivated Gasket	1	NTSS20000021CG
Spare Cable Kit for ION Trap	2	NTSST090012
ION Spare O-ring Kit Trap	2	NTSST090045
Spare Screws and Washer Kit	2	NTSST090047

Sampling Accessories

Custodion Needle Trap Samplers

The Custodion Needle Trap (NT) is a miniature thermal desorption tube used for extracting and concentrating volatile compounds from air samples used with the Clairion pump. The Custodion-NT should be used with a flow rate range of 5 – 15 mL/min. The Custodion-NT is small enough to desorb samples directly into the Torion T-9 portable GC/MS. The NT is packed with 3 different adsorption beds to give it a broad range of chemical compatibility.

Custodion SPME & CME Syringes

The Custodion SPME is ideal for quick screening and identification of volatiles. The active phase on the fiber is DVB/PDMS (Divinylbenzene/Polydimethylsiloxane), a general purpose material useful for a wide range of volatilities and chemistries.

The Custodion CME Syringes are innovative coiled microextraction sampling devices. CME is ideal for sampling liquids and dissolved solid samples. It has versatile uses including, forensic science, illicit drug screening, HAZMAT, military, environmental and food safety applications. CME uses capillary action to draw liquid sample up into the coiled wire. It is a non-specific sampling device and can be used for applications where SPME isn't ideal.

Custodion SPME Samplers

Description	Qty.	Part No.
Custodion SPME Syringe, 19 gauge blunt needle, with DVB/PDMS fiber and one replacement fiber	Pkg. 1	NTSC19SNB171
Custodion SPME Syringe, 19 gauge blunt needle, with DVB/PDMS fiber and three replacement fibers	Pkg. 1	NTSC19SN3B171
Custodion CME Syringe, 19 gauge, with one replacement coil	Pkg. 1	NTSC19SNB191
Custodion CME Syringe, 19 gauge, with three replacement coils	Pkg. 1	NTSC19SN3B191



With needle trap (NT)

With conventional trap (CT)

Custodion Needle Trap

Description	Qty.	Part No.
Custodion Needle Trap (NT) Syringe, 19 gauge blunt needle	1	NTSC19NTB200
Custodion Needle Trap (NT) Syringe, 19 gauge blunt needle	3	NTSC19NTB203
Custodion Needle Trap (NT) Syringe, 19 gauge blunt needle	5	NTSC19NTB205

Conventional Trap Sample Collection Tubes

Conventional Trap (CT) sample tubes allow for faster sampling of larger air volumes compared to direct sampling with the Needle Trap. The Custodion-CT accommodates a flow rate range of 5 – 100 mL/min. The Custodion-CT is used in conjunction with the Clairion pump for sample collection. Sample analysis requires the SPS-3 to transfer the sample onto a Needle Trap for analysis on the T-9.



Description	Part No.
Air Toxics Pre-conditioned Sample Tube (pkg. 10)	N9307001
Carbopack B 60/80 Pre-conditioned Sample Tubes (pkg. 10)	N9307002
Carbotrap 349 Pre-conditioned Sample Tubes (pkg. 10)	N9307038
Carbopack B/C/S-III Pre-Conditioned Sample Tubes (pkg. 10)	N9307000

Visit www.PerkinElmer.com for additional sample collection tubes.

Needle Trap Kits

Our Custodion Needle Trap Kits enable users to collect air samples in the field, adsorbing analytes directly onto our novel Custodion Needle Trap devices. The Needle Trap then directly inject samples into our portable GC/MS, the Torion T-9, allowing users to collect, inject and analyze air samples right at the sample's source.

The Clairion pump can operate for up to 27 hours at 1 L/min on a single charge.



Description	Part No.
Clairion Needle Trap Basic Kit (No Pump)	NTSSCL60705NP
Custodion Needle Trap Syringe, 19 gauge blunt needle Clairion NT-Pump Interface, basic O-ring/Seal Replacement Kit Seal Removal Tool	
Clairion Needle Trap Basic Kit, 110 V	NTSSCL60705
Clairion Basic Pump, 110 V Clairion Transport Case with Foam Insert Clairion NT-Pump Interface, Basic Custodion Needle Trap O-ring/Seal Replacement Kit Seal Removal Tool USB Drive with Pump User Manual	
Clairion Needle Trap Basic Kit, 220 V	NTSSCL60705I
Clairion Basic Pump, 220 V Clairion Transport Case with Foam Insert Clairion NT-Pump Interface, Basic Custodion Needle Trap O-ring/Seal Replacement Kit Seal Removal Tool USB Drive with Pump User Manual	
Clairion Conventional Trap Basic Kit, 110 V	NTSSCL60706
Clairion Basic Pump, 110 V Clairion Transport Case with Foam Insert Clairion CT to Pump Interface CT to Pump Interface O-ring Kit USB Drive with Pump User Manual	
Clairion Conventional Trap Basic Kit, 220 V	NTSSCL60706I
Clairion Basic Pump, 220 V Clairion Transport Case with Foam Insert Clairion CT-Pump Interface, Basic Whatever O-ring Kit is necessary USB Drive with Pump User Manual	

SPS-3 Accessories

Replacement CT Handle unit

Acts as interface between Needle Trap and Conventional Trap during SPS-3 desorption cycle.



Description	Part No.
Conventional Trap Handle	NTSS0060015

Replacement CT Holder unit

Holds Conventional Trap during SPS-3 desorption cycle.



Description	Part No.
Conventional Trap Holder	NTSS0060016

SPS-3 Tool Kit

Contains tools for operation and maintenance of the SPS-3.

Description	Part No.
SPS-3 Tool kit	NTSSPS30020

SPS-3 Consumables

Replacement Seal Kits

Replacement Seal and O-ring kits for SPS-3 and Accessories.



Description	Part No.
Internal Standard Module Seal Kit	NTSSPS30013
CT Holder Seal Kit	NTSSPS30011
CT Handle Seal Kit	NTSSPS30014

Carrier Gas Consumables

Disposable helium gas cylinder is a 98 mL stainless steel cylinder at ~2500 psi. Helium cylinders are used for both the T-9 GC/MS and SPS-3 during portable operation.

Description	Qty.	Purity %	Part No.
Ultra-high purity 98 mL disposable helium gas cylinder	1	99.95%	NTSST090034
Ultra-high purity 98 mL disposable helium gas cylinder	2	99.95%	NTSST090035
Ultra-high purity 98 mL disposable helium gas cylinder	6	99.95%	NTSST090036
Ultra-high purity 98 mL disposable helium gas cylinder	12	99.95%	NTSST090037
High purity 98 mL disposable helium gas cylinder	1	99.50%	NTSSG070034
High purity 98 mL disposable helium gas cylinder	2	99.50%	NTSSG070035
High purity 98 mL disposable helium gas cylinder	6	99.50%	NTSSG070036
High purity 98 mL disposable helium gas cylinder	12	99.50%	NTSSG070037

Calion Chemical Standards

Calion standards are premixed and adsorbed into a solid phase. These standards are ideal for in-field use because they contain no liquids. Calion® PV Mixes are used for Torion T-9 calibration, including both mass and GC retention time calibrations. The combination of Custodion SPME sampling with Calion standards provides robust and rapid capability for in-field calibration because they contain no liquids. Calion® PV Mixes are used for Torion T-9 calibration, including both mass and GC retention time calibrations. The combination of Custodion SPME sampling with Calion standards provides robust and rapid capability for in-field calibration.

Mininert Vials used with Custodion SPME Syringe and T-9 Instrument

Calion IS internal standard mix is to be used with the SPS-3 and Needle Traps for semi-quantitative and quantitative analysis.



Description	Qty.	Part No.
Standard Calion PV Mix (pkg. 1)	1	NTSSMIX011019
Standard Calion PV Mix (pkg. 3)	3	NTSSMIX031019

Internal Standard Ampule used with the SPS-3



Description	Qty.	Part No.
Calion IS	1	NTSSMIX0160

Liners, Seals and Filaments



Description	Part No.
GC Deactivated Injector Liner, removable 0.048 in. ID, for needle trap and SPME	NTSS2000021CG
Replacement Merlin Seal, 19 gauge for SPME and needle trap injector	NTS25700012
Replacement Filament Assembly for the T-9 Ion Source	NTSS0070034

Battery Options

Description	Part No.
Spare Li-Ion Rechargeable Battery for the T-9	NTS02750005
T-9 Single Bay Batter Charger	NTS02890001

Spare Parts

Description	Part No.
SPS Conventional Trap Assembly Mounts a Conventional Trap in a holder for use in the SPS NTSSPS30002 and NTSSPS30003	NTSS0060016
Handle Assembly for SPS Conventional Trap/Needle Trap Adapter	NTSS0060015
Conventional Trap to Pump Interface for SPS-3	NTSS0060095
Needle Trap to Pump Interface for SPS-3	NTSS00600071
Clairion™ Seal Replacement Kit for the Pump to Needle Trap Interface	NTSSCL60711
Seal Removal Tool	NTSM0060124
Clairion CT to Pump INTFC O-ring Kit for the Conventional Trap to Pump Interface	NTSSCL60708
Conventional Holder Seal and O-rings for SPS-3 for the Conventional Trap Holder	NTSSPS30011
IS Gasket Seal O-ring Kit for SPS-3	NTSSPS30013
Conventional Handle Seal with O-ring Kit for SPS-3	NTSSPS30014
Clairion Seal Replacement Kit for the NT-to-Pump Interface	NTSSCL60713
SPS-3 Tool Kit	NTSSPS30020
T-9 Basic Tool Kit	NTSTG080022
Quick Disconnect External Gas Assembly. Quick connection adapter for use with regular gas cylinders. Not for use with the disposable He cartridges	NTSSG080017
Clairion Basic Air Pump, 110 V	NTSS00600041
Clairion Basic Air Pump, 220 V	NTSS00600043
External Battery Cable, 'Pig Tail'	NTSCBL80020

Gas Management

PerkinElmer offers a wide selection of superior quality products designed to work with your PerkinElmer instruments. Our precision designed products deliver the peace of mind that comes from knowing that you'll get the results you need.

Quick Reference Index

	Page
▶ Advanced Filter System for GC	152
▶ Basic Tool Kit	161
▶ Click-On Inline Super Clean™ Purifiers	158
▶ Delux Tool Kit	161
▶ EVO Nitrogen Generators	142
▶ FID Gas Station	150
▶ FlowMark Electronic Flowmeter	164
▶ Flowmeter Plus	164
▶ GC Startup Kits	161
▶ Genius Gas (Nitrogen and Air) Generators	144
▶ N₂ Mini Whisper and Whisper Generators	143
▶ PG-H₂ Plus, NM-H₂ Plus Hydrogen Generators	148-149
▶ Ultra Clean Gas Filters for GC and GC/MS	153-156
▶ Ultra Clean Gas Filters for LC/MS	146-147
▶ Zero and Ultra Air Generators	151

Flowmeter Plus

The Flowmeter Plus is a valuable tool for troubleshooting detector problems. Measuring gas volumetrically eliminates the need to select gas type.

[▶ VIEW PAGE](#)



Advanced Filter System

Gas purifiers remove contaminants from gas sources, thereby improving system performance. The Advanced Filter System has high capacity and efficiency levels for oxygen, water and hydrocarbons.

[▶ VIEW PAGE](#)



Click-On Inline Super Clean™ Purifiers

Using the Click-On Connectors lets you change the trap without introducing contaminants into your system. Click-On connectors can replace a trap, without introducing impurities into the system. This in turn eliminates the need to flush the system.



[▶ VIEW PAGE](#)

NEW PKI-Pure Purifiers

Rated to 1000 psi, PerkinElmer's new range of PKI-Pure Purifiers are designed to reduce contaminants to low ppb levels, with very high capacity in a compact design.



[▶ VIEW PAGE](#)

LC-MS GAS GENERATORS

LC-MS GAS FILTERS

LC-MS ACCESSORIES

GC GAS GENERATORS

GC GAS FILTERS

GC ACCESSORIES

Gas Generators – Simply a Smarter Choice

Analytical gas generators can remove the requirement for high-pressure cylinder gases and are typically placed next to the instrument they are servicing. This removes any need for extended gas lines and negates any associated problems impacting on purity, cost and convenience.

The latest gas generators from PerkinElmer utilize new technologies in adsorbents, catalysts, and specialist micro dryers to produce a continual supply of ultra-high purity gases to your instrumentation. This all but eliminates the introduction of impurities, which can be reduced further by the installation of in-line gas purifiers.

Nitrogen Generators

EVO Nitrogen Generators

The EVO N₂ nitrogen generators are designed as a full 'plug and play' solution with integral oil free, low noise compressors. The EVO Nitrogen hybrid gas model was specifically designed to meet the flow, purity and pressure requirements of the LC/MS /MS applications of AB SCIEX with appropriate pressures and flows of nitrogen. The simple and proven pressure swing adsorption (PSA) technology is employed to remove nitrogen from compressed air. Carbon molecular sieves (CMS) adsorb remaining oxygen and traces of humidity. These generators require minimal maintenance and operator attention. They are CE CSA certified.



Technical Specifications for all Nitrogen Generators

Description	Specification
Purity	99.5 %
Outlet Pressure	8 bar/120 psi
Height	64.1 cm (25.2 in.)
Width	48.2 cm (19 in.)
Depth	83.5 cm (32.9 in.)
Weight	121 kg (266 lbs)
Operating Temperature	+10 °C to +40 °C (+50 °F to +104 °F)
Operating Relative Humidity	0 – 80 % rF, no condense/0 – 99 % rF with condense drain
Power Consumption	1300 Watt
Circuit Breaker	10 A for 230 V ; 15 A for 110 V
Heat Dissipation Approx	2700 Btu/h

Nitrogen Model	Flow Rate	Voltage (V)	Part No.
EVO N ₂	25 L/min	115	N9308587
	25 L/min	220	N9308573
	35 L/min	115	N9308588
	35 L/min	220	N9308574
EVO N ₂ Hybrid	Up to 10 L/min +/- 1.5 L/min (at atmospheric pressure) 35 L/min of AIR@116 psi	115	N9308590
	Up to 10 L/min +/- 1.5 L/min (at atmospheric pressure) 35 L/min of AIR@116 psi	220	N9308576

N₂ Whisper Generators

The Whisper nitrogen generator has been developed to meet specific requirements in terms of flow, purity and pressure in LC/MS applications. It can also be used for the evaporation of solvents in samples being analyzed. The simple high efficiency membrane technology allows nitrogen separation from other air components present within the supplied compressed air.

Better results: The constant purity of nitrogen improves system stability and ensures reproducible results.

Saving you money: Initial investment is typically paid back in less than a year. No plumbing is required to transfer gas from the storeroom to the lab.

Better lab efficiency: Constant supply of high quality nitrogen, in line with your application demands. Gas cylinders are often insufficient to ensure the large nitrogen volumes needed in LC/MS techniques.

Improved safety: Nitrogen is produced at low pressure and room temperature eliminating the risks related to high pressure gas bottle use and the hazards associated with liquid nitrogen.

Simple installation: A plug and play approach. The wall-mounted installation saves precious bench space!

N₂ Mini Whisper Generators

Based upon the Whisper generator, the Mini Whisper Nitrogen generator provides the same high purity nitrogen, but at a lower flow rate. It is ideally suited to ELSD applications as well as LC/MS analysis.

The simple yet high efficiency membrane technology allows the separation of nitrogen from the other components of the compressed air inlet.

The low pressure drop allows the unit to be connected to an existing dry and oil-free compressed air source in the lab.



N₂ Mini Whisper Generator



N₂ Whisper Generator

Technical Specifications

Description	Whisper	Mini Whisper
Purity (based on outlet flow)	> 98 – 99.5 %	> 98 – 99.5 %
Outlet Pressure	7 bar	7 bar
Height	115 cm (45.3 in.)	73.5 cm (28.9 in.)
Width	48 cm (19 in.)	34.8 cm (13.7 in.)
Depth	26 cm (10.2 in.)	35 cm (13.8 in.)
Weight	15 kg (33 lbs) ; 18 kg (39 lbs); 21 kg (46 lbs)	8 kg (18 lbs)
Operating Temperature	+10 °C to +35 °C (+50 °F to +95 °F)	+10 °C to +35 °C (+50 °F to +95 °F)
Air Compressor Supplied	NO	NO
Electrical Requirements	None	None
Background Noise	None	None
Connections	1/4 G	1/4 G

Description	Flow Rate	Part No.
Whisper	40 L/min	N9306285
	80 L/min	N9306286
	120 L/min	N9306287
Mini Whisper	12 L/min	N9306288

Genius Gas Generators

With curated and dedicated gas solutions for PerkinElmer, PEAK Scientific has developed optimal performing gas generators for your lab. The generators are engineered for your instrument to deliver the consistent flow and purity you demand, at the push of a button. If you're looking for a gas generator that you can rely on, is cost efficient, and highly efficient in streamlining your workflow – look no further than PEAK. With training and certification from PEAK, our PerkinElmer engineers are prepared for available services from installation, preventative maintenance, and general needs, we've got you covered worldwide. With us, you can be assured your lab is running smoothly – day to day, analysis to analysis.

Genius XE QSD

Nitrogen and Air Generator for PerkinElmer QSight® Dual Source LC/MS/MS

Advanced technology coupled with robust features, Genius XE QSD provides a quality standalone nitrogen solution custom designed to meet the requirements of our QSight Dual Source LC/MS/MS.



Featuring dual outlets (nitrogen and air), the generator was built to reduce size, noise, and heat emissions. Genius XE QSD has been tested and validated by our trusted engineers for use with the QSight and accompanied by factory pre-set pressures which allows for flows to meet the precise demands of our system.

Features and Benefits

- Multi-Stage Drying Filtration to efficiently remove moisture and contaminants, providing a consistent quality of gas
- Low environmental lab impact with low noise and heat emissions
- Next-generation high performance premium compressors
- Intuitive LED Service Indication
- ECO (Electronic Compressor Optimisation™) technology for low energy consumption and compressor durability
- Fixed annual maintenance schedule
- One year manufacturer's warranty

Description	Genius XE QSD
Part Number	N2800014
Nitrogen Maximum Flow	16 L/min @ 5.52 bar (0.57 cfm @ 80 psi)
Air Maximum Flow	67 L/min @ 7.58 bar (2.37 cfm @ 110 psi)
Dewpoint	Nitrogen ≤ -40 °C Dry Air ≤ -20 °C
Gas Outlets	2 x ¼" BSPP
Drain Outlet	1 x ¼" BSPP
Particles	<0.01 µm
Phthalates	None
Suspended Liquids	None
Operating Temperature	15 °C (59 °F) to 30 °C (86 °F)
Electrical Requirements	220-240 V ± 10% 50/60 Hz
Power Consumption	1.64 kVA
Heat Output	<5545 BTU
Noise Level	57dB(A) @ 1 m
Dimensions (HxWxD)	700 x 570 x 897 mm 27.6 x 22.5 x 35.4 in.
Weight	153 kg

Genius 1025

Nitrogen and Air Generator for PerkinElmer Instrumentation

With up to 15 L/min of LC/MS grade nitrogen and up to 35 L/min of air being produced in a single output, the Genius 1025 was specifically designed to meet the requirements of our QSight Triple Quad 110 and 210 Single Source LC/MS/MS systems.



This gas generator was outfitted using membrane technology to produce LC/MS grade purity and an internal air dryer to be an all-in-one solution.

Features and Benefits

- Self-contained solution with integrated compressors so no need for an external air supply
- Economical and efficient source of nitrogen/dry air with low lifetime running costs
- Easy to use – gas at the push of a button
- One year on-site warranty

Description	Genius 1025
Part Number	N2800012
Maximum Flow	Up to 15 L/min Nitrogen and up to 35 L/min Dry Air
Min/Max Pressure	Up to 80 psi Nitrogen and up to 110 psi Dry Air
Gas Outlets	2 x ¼" BSPP
Maximum Relative Humidity	80% Non-Condensing
Maximum Altitude	2000 m
Particles	<0.01 µm
Phthalates	None
Suspended Liquids	None
Operating Temperature	5 °C (41 °F) to 30 °C (86 °F)
Electrical Requirements	230 V ± 10% 50/60 Hz 7A
Power Consumption	<1,265 VA
Heat Output	3,925 BTU/Hr
Noise Level	57dB(A) @ 1m
Dimensions (HxWxD)	713 x 600 x 750 mm 28.1 x 23.7 x 29.6 in.
Weight	108.5 kg / 239.3 lbs
Shipping Weight	137 kg / 302.1 lbs

Ultra Clean Gas Filters for LC/MS

Cartridge systems make changing gas filters quick and easy. A base plate allows cartridges to be exchanged without introducing ambient air. Spring-loaded check valves seal when a filter is removed and open only when a new filter has been locked in place.



To meet the high flow needs of the LC/MS system, the hydrocarbon or moisture filled cartridges are positioned and placed in parallel. The incoming gas stream is split equally between the cartridges and the two streams are re-joined after purification but before the gas exits the base plate. Get up and running with speed and benefit from increased sensitivity by removing unwanted moisture and hydrocarbons. These filters typically last 3 to 6 months.

When the easy to read indicators change color it is a signal of a major leak upstream or downstream, a high concentration of contaminants or too late replacement or filter replacement is overdue. This is the time to swap a filter.

Features and Benefits

- High purity output insures 99.9999 % pure gas
- No tool replacement of filter cartridges, no need to shut gas flow off with quick disconnect base plate
- Easy to read indicators to determine replacement interval
- Helium and Hydrogen specific cartridges available: operational with 15 minute purge after installation
- Safety shielding of glass filter with plastic cover
- Serial numbered for ease of tracking
- Ultra-high capacity

Comparing baseline performance with PerkinElmer SuperClean filters vs. a competitive polymer housed filter.

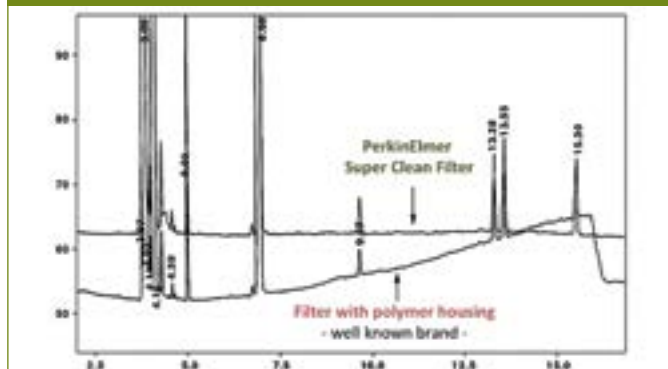

Impact of Gas Purity on LC/MS Sensitivity

The use of a gas purification filter on the nitrogen line for LC/MS has an important influence on sensitivity. If no filter is used, the background is much higher and the S/N ratio is reduced (this can be as much as a factor of 10).

LC/MS background is much lower and S/N ratio is higher when using a filter.

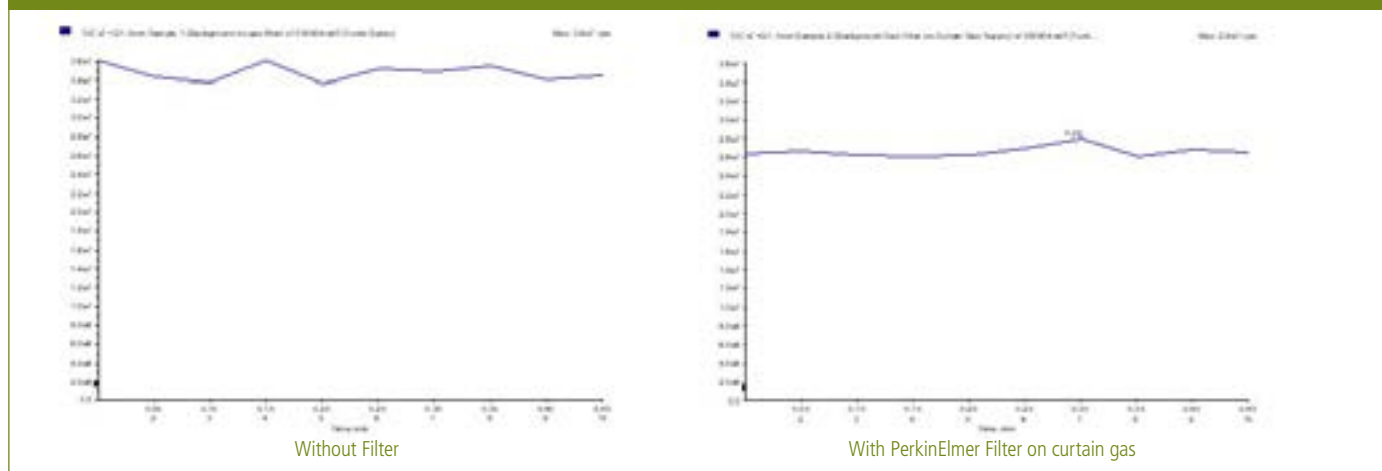

Ultra Clean Gas Filters and Kits for LC/MS

To meet the high flow needs of the LC/MS system, the hydrocarbon or moisture filled cartridges are positioned and placed in parallel. The incoming gas stream is split equally between the cartridges and the two streams are re-joined after purification but before the gas exits the base plate. Get up and running with speed and benefit from increased sensitivity by removing unwanted moisture and hydrocarbons.

Ultra-High Capacity Hydrocarbon Filter Bundle

Up to 20 L/min of hydrocarbon-free nitrogen per minute.



Capacity	
HC	24 g (as n-butane)
Description	Specification
Outlet Gas Quality (%)	> 99.9999
Maximum Pressure	15 bar (217 psi)
Maximum Flow	20 L/min
Usable For	Nitrogen
Dimensions	24 cm x Ø 4.4 cm
Weight	0.26 Kg
Estimated Lifetime	3 to 6 months
Part No.	N9306823

Ultra-High Capacity Moisture Filter Bundle

High Flow moisture filters are ideal for central purifying solutions.



Moisture in carrier gas lines will prematurely degrade oxygen and hydrocarbon traps and increase detector noise. As a precaution, we highly recommend installing a moisture trap before the hydrocarbon and oxygen traps on all carrier gas lines.

Capacity	
H ₂ O	14.4 g
Description	Specification
Outlet Gas Quality (%)	> 99.9999
Maximum Pressure	15 bar (217 psi)
Maximum Flow	20 L/min
Usable For	Inert carrier gas, He, H ₂ , N ₂ , Ar, Air
Dimensions	24 cm x Ø 4.4 cm
Weight	0.26 Kg
Estimated Lifetime	3 to 6 months
Part No.	N9306824

Ultra Clean Filter Kits for LC/MS



Description	Qty.	Part No.
Ultra Clean 2 High Flow Hydrocarbon Filter Kit – 1/4 in. Brass: Includes (1) 2 position high flow base plate with 1/4 in. Brass inlet/outlet fittings, (2) High Flow Hydrocarbon Traps, and a 1/4 in. Brass Particle Filter	Kit	N9306840
Ultra Clean 2 High Flow Hydrocarbon Filter Kit – 1/4 in. Stainless Steel: Includes (1) 2 position high flow base plate with 1/4 in. Stainless Steel inlet/outlet fittings, (2) High Flow Hydrocarbon Traps, and a 1/4 in. Brass Particle Filter	Kit	N9306841

Ultra Clean Filter Base Plates for LC/MS



Description	Qty.	Part No.
Ultra Clean Base Plate 1 Position – 1/4 in. Brass	1	N9306800
Ultra Clean Base Plate 1 Position – 1/8 in. Brass	1	N9306801
Ultra Clean Base Plate 1 Position – 1/4 in. Stainless Steel	1	N9306802
Ultra Clean Base Plate 1 Position – 1/8 in. Stainless Steel	1	N9306803
Ultra Clean Base Plate 2 Position – 1/4 in. Brass	1	N9306804
Ultra Clean Base Plate 2 Position – 1/8 in. Brass	1	N9306805
Ultra Clean Base Plate 2 Position – 1/4 in. Stainless Steel	1	N9306806
Ultra Clean Base Plate 2 Position – 1/8 in. Stainless Steel	1	N9306807
Ultra Clean Base Plate 3 Position – 1/4 in. Brass	1	N9306810
Ultra Clean Base Plate 3 Position – 1/8 in. Brass	1	N9306811
Ultra Clean Base Plate 3 Position – 1/4 in. Stainless Steel	1	N9306812
Ultra Clean Base Plate 3 Position – 1/8 in. Stainless Steel	1	N9306813

Replacement Filter Bundles for LC/MS

Description	Qty.	Part No.
Ultra Clean High Flow Hydrocarbon Filter Bundle: Includes (2) High Flow Hydrocarbon Filters	1 bundle of 2 cartridges	N9306823
Ultra Clean High Flow Moisture Filter Bundle: Includes (2) High Flow Moisture Filters	1 bundle of 2 cartridges	N9306824

Ultra Clean Replacement Individual Cartridge Filters for LC and LC/MS

Description	Qty.	Part No.
Ultra Clean Moisture Filter	1	N9306814
Ultra Clean Oxygen Filter	1	N9306815
Ultra Clean Hydrocarbon Filter	1	N9306816
Ultra Clean Combi (Hydrocarbon/Moisture) Filter	1	N9306818
Ultra Clean Triple (Oxygen/Moisture/Hydrocarbon) Filter	1	N9306819
Ultra Clean Triple (Oxygen/Moisture/Hydrocarbon) Helium-specific Filter	1	N9306820
Ultra Clean Triple (Oxygen/Moisture/Hydrocarbon) Hydrogen-specific Filter	1	N9306822

Base Plates



Ultra Clean High Flow Base Plates for LC/MS

Description	Qty.	Part No.
Ultra Clean High Flow base plate 2 position – 1/4 in. Brass: Includes 1/4 in. Stainless Steel particle filter	1	N9306808
Ultra Clean High Flow base plate 2 position – 1/4 in. Brass: Includes 1/4 in. Stainless Steel particle filter	1	N9306809

Accessories

Particle Filter for LC/MS



Description	Qty.	Part No.
Ultra Clean 0.5 Micron Particle Filter – 1/4 in. Brass	1	N9306856
Ultra Clean 0.5 Micron Particle Filter Cup Replacement Pack	12	N9306857

Ultra Clean Base Plate Fittings for LC/MS



Description	Qty.	Part No.
Ultra Clean High Flow Connector Set – 1/4 in. Brass	6	N9306850
Ultra Clean High Flow Connector Set – 1/4 in. Stainless Steel	6	N9306851

Ultra Clean Base Plate Flush Cap Replacement Set for LC/MS



Description	Qty.	Part No.
Ultra Clean High Flow Flush Cap Replacement Set	2	N9306853

Wall Mounting Bracket for All Cartridge Base Plates



Description	Qty.	Part No.
Ultra Clean Wall-mounting Bracket Set	1	N9306855

Replacement O-rings for All Cartridge Base Plates



Description	Qty.	Part No.
Ultra Clean Base Plate O-ring Replacement Set	20	N9306854

High Capacity Hydrocarbon Trap



Description	Part No.
High Capacity Hydrocarbon Trap	N9301208

- Eliminates potential hydrocarbon background to insure best LC/MS results
- Contains 750 cc of preconditioned activated charcoal
- Stainless steel body. 1/4 in. brass compression fittings with ferrules for installation
- Maximum pressure 200 psi
- Recommended flow rate up to 2 Liters/minute
- Will remove hydrocarbon impurities (50 ppm or less) from inert gases, nitrogen and hydrogen at room temperature to low ppb range
- Capacity of 67 g of hydrocarbons C5 and heavier
- 10 µm stainless steel porous frits protect gas stream from particulates
- Individually helium leak tested. Shipped filled with helium
- 2 in. OD x 20 in. L (including fittings)
- Weight 3.5 lb/1.6 kg
- Maximum flow rate 57 SLPM, reduces hydrocarbons < 5 ppb at outlet

Gas Generators – Simply a Smarter Choice

Analytical gas generators can remove the requirement for high-pressure cylinder gases and are typically placed next to the instrument they are servicing. This removes any need for extended gas lines and negates any associated problems impacting on purity, cost and convenience.

The latest gas generators from PerkinElmer utilize new technologies in adsorbents, catalysts, and specialist micro dryers to produce a continual supply of ultra-high purity gases to your instrumentation. This all but eliminates the introduction of impurities, which can be reduced further by the installation of in-line gas purifiers.

Hydrogen Generators

PerkinElmer offer a range of hydrogen generators to cater for the varying configurations of gas supply required across different laboratories and applications.

Hydrogen Generator Options and Capabilities

Model	GC Detector Gas Applications	GC, GC/MS Carrier Gas Applications	Zero Air	Automatic Cascading Capability	Desiccant Cartridge to Replace
PG Plus	■			■	
NM Plus	■	■		■	
FID Gas Station Plus	■	■	■		
High Purity	■				■
Ultra High Purity	■	■			

PG-H₂ Plus Hydrogen Generators

The PG (Pure Gas) hydrogen generators employ the newest membrane technology available for the safe production of pure hydrogen gas. This patented design is ideal for operation with gas analyzers, as fuel gas for flame tools, or as a source for pure hydrogen in plasma chambers and other isolated environments. Electrolytic membrane technology is preferred over alternative hydrogen generating techniques because it is clean, requires less maintenance and there is no need to store chemicals to maintain operation. The generators offer silent operation and require only deionized or distilled water with no caustic solutions which can affect the purity of the hydrogen.



A Safe Source of Hydrogen

The PG-H₂ generators have an auto shutoff procedure that places the units in standby in the event of an internal error and selectable alarms allow the user to be informed whenever operating conditions vary from the set point. They are CE CSA FCC certified.

Applications

This series of generators are ideal for use with GC detectors such as FID, NPD, TCD and FPD.

Technical Specifications for PG-H₂ Plus Models

Description	Specification
Purity	99.999 %/hydrocarbon free < 0.1 ppm
Delivery Pressure	20 – 160 psig/1.4-11 barg
Height	43 cm (16.9 in.)
Width	23 cm (9.1 in.)
Depth	36 cm (14.2 in.)
Weight	20 kg (44 lbs)
Ambient Temperature Range	-20 °C to + 60 °C (-4 °F to + 140 °F)
Water Quality	Deionized or distilled <10 µS conductivity
Supply Voltage Range	230 V/50 – 60 Hz – 110 V/60 Hz – 100 V/60 Hz
Fitting	1/8 in. for the H ₂ outlet

PG-H₂ Plus Generator Models

Flow Rate	Part No.
100 mL/min	N9308577
160 mL/min	N9308578
250 mL/min	N9308579
500 mL/min	N9308580

PG-H₂ Plus Generator Replacement Parts

Description	Part No.
Deionizer Bag	N9307097

NM-H₂ Plus Hydrogen Generators

The NM (No Maintenance) series of hydrogen generators employ the newest membrane technology available for the safe production of pure hydrogen gas. This patented design is ideal for operation with gas analyzers, as fuel gas for flame tools, or as a source for pure hydrogen in plasma chambers and other isolated environments.

Electrolytic membrane technology is preferred over alternative hydrogen generating techniques. The generators offer silent operation and require only deionized or distilled water with no caustic solutions which can affect the purity of the hydrogen.

No Maintenance

The proprietary auto drying technology has facilitated a design that does not require a desiccant cartridge, yet produces a constant supply of dry, ultra-high purity hydrogen. As the PG-H₂ and the NM hydrogen generators have an auto shutoff procedure that places the units in standby in the event of an internal error and selectable alarms allow the user to be informed whenever operating conditions vary from the set point.

Applications

The NM-H₂ Hydrogen Pure Gas Generators enhances the high performance of the PG Plus series, with the addition of a unique no maintenance purification system. It provides a stream of ultra-high purity hydrogen for both carrier gas and detector gas applications, including MS.

Robust Supply – 100% Up Time

Multiple generators can be set up in parallel to spread the load of gas generation, known as cascading. Building in a level of spare capacity with a master/slave set up ensures that there is no interruption in supply.

The NM-H₂ generators are the only generators on the market that automatically cascade, no lab personal intervention is required ensuring the smooth running of your laboratory around the clock.



Technical Specifications for NM-H₂ Plus Models

Description	Specification
Purity	99.9999 %/hydrocarbon free < 0.1 ppm
Delivery Pressure	20 – 160 psig/1.4 – 11 barg
Height	43 cm (16.9 in.)
Width	23 cm (9.1 in.)
Depth	36 cm (14.2 in.)
Weight	20 kg (44 lbs)
Ambient Temperature Range	-20 °C to + 60 °C (-4 °F to + 140 °F)
Water Quality	Deionized or distilled <10 µS conductivity
Supply Voltage Range	230 V/50 – 60 Hz – 110 V/60 Hz – 100 V/60 Hz
Fitting	1/8 in. for the H ₂ outlet

NM-H₂ Plus Generator Models

Flow Rate	Part No.
100 mL/min	N9308581
160 mL/min	N9308582
250 mL/min	N9308583
500 mL/min	N9308584
1000 mL/min	N9308585

PG-H₂ Plus NM-H₂ Plus Generator Accessories

Description	Part No.
I/O Board	N9307094
Cable for Cascading*	N9307093
Remote Control RS-232 (includes converter, cables and software)*	N9307095
Auto Refill *	N9307096

* Requires I/O Board.

NM-H₂ Plus Generator Replacement Parts

Description	Part No.
Deionizer Bag	N9307097

FID Gas Station

The FID gas station is a novel system that combines the reliability of the high purity PG or ultrahigh purity NM hydrogen generators with the superior performance of the zero air generators into a single compact instrument. Designed with space saving in mind, it sits directly under the GC to conserve bench space. You can also apply the FID gas station to GCMS systems with the simple addition of a drawer tray for the MS to rest on. If you want to benefit from the space saving design, but only require a H₂ generator than that is also an option.

Features and Benefits

- H₂ flow rate from 100-1000 mL/min
- H₂ pressure up to 11 bar
- Zero air flow rates 5 L/min
- Zero air purity <0.1 ppm
- Minimal maintenance
- CE, CSA, FCC certified



Technical Specifications

Description	Capability	Flow Rate	Part No.
FID Station PG Plus	H ₂	150 mL/min	N9300023
FID Station PG Plus	H ₂	260 mL/min	N9300024
FID Station NM Plus	H ₂	150 mL/min	N9300020
FID Station NM Plus	H ₂	350 mL/min	N9300021
FID Station NM Plus	H ₂	650 mL/min	N9300022
FID Station PG Plus	H ₂ and Air	150 mL/min + Air 1500 mL/min	N9300018
FID Station PG Plus	H ₂ and Air	260 mL/min + Air 1500 mL/min	N9300019
FID Station NM Plus	H ₂ and Air	150 mL/min + Air 1500 mL/min	N9300015
FID Station NM Plus	H ₂ and Air	350 mL/min + Air 1500 mL/min	N9300016
FID Station NM Plus	H ₂ and Air	650 mL/min + Air 1500 mL/min	N9300017
FID Station NM Plus Extension Drawer			N9308567

Zero and Ultra Air Generators

The Zero and Ultra Zero Air Generators produce laboratory grade purified air for FID (flame ionization detectors) and other detectors. Designed with safety and convenience in mind, this system will generate purified and hydrocarbon free air from an existing in-house oil-free compressed air supply, eliminating the need for inconvenient high-pressure gas cylinders. Eliminating gas cylinders reduces annual operating costs associated with materials, labor, and down-time.

The Zero/Ultra Zero Air Generator series removes hydrocarbon pollutants to less than 0.1 ppm, and all forms of particles. Operation of the generator requires low levels of electrical power consumption. This complete turnkey system is engineered with the highest quality components, is easy to install, and requires minimal annual maintenance. The Ultra Zero Air Generators will remove CO and hydrocarbon pollutants to less than 0.1 ppm, and NOx contaminants to 1 ppm. Carbon dioxide is also removed to about 1 ppm levels. They are CE CSA FCC certified.

Specifications for Zero and Ultra Zero Air

Description	Specification
Outlet Hydrocarbon Concentration	< 0.1 ppm
Outlet Carbon Monoxide Concentration	< 0.1 ppm
Outlet Particles < 0.5 Microns Removed	99.99%
Outlet Air Temperature	Ambient + 15 °C
Max Inlet Hydrocarbon Concentration	100 ppm
Maximum Outlet Pressure	6.5 bar
Max Inlet Carbon Monoxide Concentration	50 ppm
Max Inlet Temperature	40 °C
Inlet Pressure Range (regulated to 7 bar)	4.5 – 10 bar
Inlet Port	1/4 in. NPT
Outlet Port	1/8 in. NPT

Specifications for Zero Air

Outlet Zero Air	Maximum Continuous Output Flow Rate	Electrical Requirements	Temperature/ Pressure Control Board	Part No.
1.5 L/min	1.5 L/min	230/115 VAC 250 W max	Included	N9307075
3.0 L/min	3.0 L/min	230/115 VAC 250 W max	Included	N9307076
6.0 L/min	6.0 L/min	230/115 VAC 250 W max	Included	N9307077
15.0 L/min	15.0 L/min	230/115 VAC 480 W max	Included	N9307078
30.0 L/min	30.0 L/min	230/115 VAC 480 W max	Included	N9307079



Wall Mountable

Ultra Zero Air Generators

Features and Benefits

- Purity: < 0.1 ppm hydrocarbon; < 0.1 ppm CO; < 1 ppm NOx; < 5 ppm CO₂
- Produce laboratory-grade purified air for the most accurate and convenient calibration of testing equipment
- Designed with safety and convenience in mind, this system will generate purified air from an existing in-house oil-free compressed air supply, eliminating the need for inconvenient high-pressure gas cylinders
- Eliminate gas cylinders reducing annual operating costs associated with materials, labor and downtime, and reduces risk of injury to workers
- Will remove CO and HC pollutants to less than 0.1 ppm and NOx contaminants to 1 ppm. Carbon dioxide is also removed to about 1 ppm levels. Operation of the generator requires low levels of air consumption and electrical power
- Fully supported by PerkinElmer Service Organization
- All models come without a compressor. An oil free compressor is required
- CE, CSA certified

Specifications for Ultra Zero Air

Outlet Ultra Zero Air	Outlet Carbon Dioxide Concentration	Outlet Nitrogen Oxides Concentration	Outlet Dewpoint (°C)	Electrical Requirements	Part No.
1.5 L/min	< 5 ppm	< 0.1 ppm	< -70	230/115 VAC 270 W max	N9307081
3.0 L/min	< 10 ppm	< 1 ppm	< -50	230/115 VAC 270 W max	N9307082
6.0 L/min	< 10 ppm	< 1 ppm	< -50	230/115 VAC 270 W max	N9307083
15.0 L/min	< 10 ppm	< 1 ppm	< -50	230/115 VAC 500 W max	N9307080

GC Gas Purification Systems

Designed to reduce contaminants in gases commonly used in laboratory applications to low-ppb levels, gas purification systems are an essential part of any GC system to ensure optimal operation.

There are a number of different options, summarized below, that vary in configuration, capacity and the number of instruments that can be supported.

Gas Filter System	Mounting	Capacity	Quick Change Cartridge	Indicator	Triple Filter Configuration	Number of GC Supported
Ultra Clean	Bench	Low	Yes	Yes	Yes	1
In Line	Wall	High	No	No	No	Multiple
Advanced Filter	Wall or Bench	High	Yes	Yes	Yes	Multiple

Advanced Filter System

The Advanced Filter System has high-capacity and efficiency levels for oxygen, water and hydrocarbons. The recommended maximum flow rate is 2 L/min with 200 psi maximum operating pressure.

A polycarbonate shield surrounding the glass indicator section of the filter is sealed, unlike other gas filters, the gas flow is secure even if the glass should break. This redundant sealing system and robust construction provides a new level of security in gas filtration.

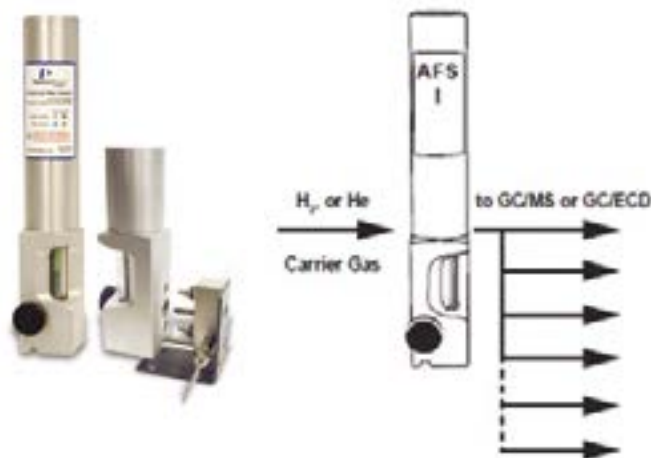

Features and Benefits

- Two indicators – for oxygen and moisture
- High capacity and efficiency in a single, easy to replace, cartridge
- Double-seal construction for safety
- Check valves protect gas lines during replacement
- Includes mounting hardware for bench or wall
- Reduces oxygen < 5 ppb, moisture < 20 ppb, and hydrocarbons < 5 ppb at outlet

Description	Part No.
Advanced Filter System	N9303963
Replacement Cartridge for Oxygen, Water and Hydrocarbons (1/8" SS)	N9303964
Manifold and Mounting Hardware	N9306139

Description	Capacity	Efficiency
Oxygen	850 cc	<5 ppb
Water	12 g	<20 ppb
Hydrocarbons	8 g	<5 ppb

Ultra Clean Gas Filters

Wrenches to change filters is a thing of the past. There is no longer a need for loosening and tightening fittings every time a trap is changed, which may contaminate your system during the process. Cartridge systems make changing gas filters quick and easy. A base plate allows cartridges to be exchanged without introducing ambient air. Spring-loaded check valves seal when a filter is removed and open only when a new filter has been locked in place.



Features and Benefits

- High purity output insures 99.9999 % pure gas
- No tool replacement of filter cartridges, no need to shut gas flow off with quick disconnect base plate
- Easy to read indicators to determine replacement interval
- Helium and Hydrogen specific cartridges available: operational with 15 minute purge after installation
- Safety shielding of glass filter with plastic cover
- Serial numbered for ease of tracking
- New improved design has a maximum pressure rating of 15 bar (217 psi)
- QR Code Status Monitoring offers the ability to set maintenance reminders, view current status of the filter, and view certification
- Universal ring nut ensures compatibility with existing baseplates

Carrier Gas Purity

Carrier gas should contain less than 1 ppm of oxygen, moisture, or other trace contaminants to prevent column degradation, increase column lifetime, and decrease stationary phase bleed. The expense of using high purity gases in combination with carrier gas line purifiers will be offset by longer column lifetime and less GC maintenance.

Contaminants cause ghost peaks to appear during temperature programming and degrade the validity of analytical data. Make-up gas also should be contaminant-free, or baseline fluctuations and excessive detector noise can occur. Detector gases should be free of water and hydrocarbons, or excessive baseline noise can result. Gas purifiers remove these contaminants from gas sources, thereby improving system performance.

When the easy to read indicators change color it is a signal on a major gas carrier problem; a major leak upstream or downstream, a high concentration of contaminants or to late replacement or filter replacement is overdue. This is the time to swap a filter.

Comparing baseline performance with PerkinElmer SuperClean filters vs. a competitive polymer housed filter.

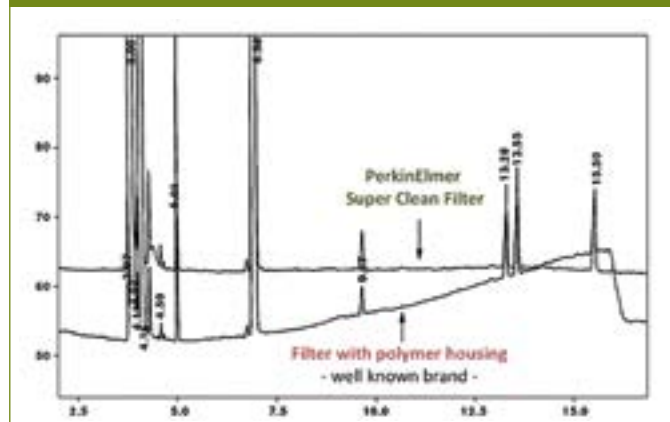

To prevent contamination or saturation issues, the filter should be swapped every 12 months, as a minimum, regardless the indicator has changed color or not. Some high throughput applications may need the filter changing every 6 months.

Ultra Clean Gas Filter Kits for GC and GC/MS

Available with different sized fittings, (1/8 in. or 1/4 in.) in brass or stainless steel, these complete filter kits contain everything you need to quickly and easy install into your analytical system; instantly assuring you of a continual high purity gas supply.

Triple Filter Kit for MS/ECD/NPD

The triple combination filter kit is ideal for purifying GC/MS carrier gases. It contains oxygen, moisture and hydrocarbon scrubbers in one easy to change economical cartridge. There is of a range of brass and stainless steel base plate fittings and options for hydrocarbon trap to be helium or hydrogen specific, in addition to the general carrier gas.

Description	Qty.	Part No.
PerkinElmer Triple (Oxygen/Moisture/Hydrocarbon) Filter Kit – 1/4 in. Brass Kit: Includes (1) 1 position base plate with 1/4 in. Brass inlet/outlet fittings and (1) Oxygen/Moisture/Hydrocarbon Trap	Kit	N9306828
PerkinElmer Triple (Oxygen/Moisture/Hydrocarbon) Filter Kit – 1/8 in. Brass kit: Includes (1) 1 position base plate with 1/8 in. Brass inlet/outlet fittings and (1) Oxygen/Moisture/Hydrocarbon Trap	Kit	N9306829
PerkinElmer Triple (Oxygen/Moisture/Hydrocarbon) Filter Kit – 1/4 in. Stainless Steel kit: Includes (1) 1 position base plate with 1/4 in. Stainless Steel inlet/outlet fittings and (1) Oxygen/Moisture/Hydrocarbon Trap	Kit	N9306830
PerkinElmer Triple (Oxygen/Moisture/Hydrocarbon) Filter Kit – 1/8 in. Stainless Steel kit: Includes (1) 1 position base plate with 1/8 in. Stainless Steel inlet/outlet fittings and (1) Oxygen/Moisture/Hydrocarbon Trap	Kit	N9306831
PerkinElmer Triple Filter (Oxygen/Moisture/Hydrocarbon)	1	N9306819
PerkinElmer Triple Filter (Oxygen/Moisture/Hydrocarbon): Helium specific filter	1	N9306820
PerkinElmer Triple Filter (Oxygen/Moisture/Hydrocarbon): Hydrogen specific filter	1	N9306822



Configuration	Benefit
GC/MS	Higher data accuracy and less maintenance
GC/ECD	Greater sensitivity
GC/TCD	Greater sensitivity and less maintenance

Complete Triple Filter Bundle Kit for FID

This complete filter kit is the perfect all-in-one solution for purifying Flame Ionization Detector (FID) fuel gases together with the carrier gas. The triple filter simultaneously hydrocarbons, moisture and oxygen are removed from the carrier gas and combi filter removes both moisture and hydrocarbons from the hydrogen and air fuel gases. The kit consists of one triple filter and two combi filters (hydrogen and air) together with one three position base plate. There are a range of base plate fittings options available.

Description	Qty.	Part No.
PerkinElmer 3 Filters Kit – 1/4 in. Brass: Includes (1) 3 position base plate with 1/4 in. Brass inlet/outlet fittings and (1) Oxygen/Moisture/Hydrocarbon Trap and (2) Hydrocarbon/Moisture Traps	Kit	N9306842
PerkinElmer 3 Filters Kit – 1/8 in. Brass: Includes (1) 3 position base plate with 1/8 in. Brass inlet/outlet fittings and (1) Oxygen/Moisture/Hydrocarbon Trap and (2) Hydrocarbon/Moisture Traps	Kit	N9306843
PerkinElmer 3 Filters Kit – 1/4 in. stainless steel: Includes (1) 3 position base plate with 1/4 in. stainless steel inlet/outlet fittings and (1) Oxygen/ Moisture/ Hydrocarbon Trap and (2) Hydrocarbon/Moisture Traps	Kit	N9306844
PerkinElmer 3 Filters Kit – 1/8 in. stainless steel: Includes (1) 3 position base plate with 1/8 in. stainless steel inlet/outlet fittings and (1) Oxygen/Moisture/Hydrocarbon Trap and (2) Hydrocarbon/Moisture Traps	Kit	N9306845
PerkinElmer Triple Filter – (Oxygen/Moisture/Hydrocarbon)	1	N9306819
PerkinElmer Combi (Hydrocarbon/Moisture) Filter	1	N9306818
PerkinElmer Filter Bundles: Includes (1) Oxygen/Moisture/Hydrocarbon Trap and (2) Hydrocarbon/Moisture Traps	3	N9306826



Configuration	Benefit
GC/FID	Improved reproducibility and sensitivity

Ultra Clean Gas Filters for GC and GC/MS

The easy to use leak-tight cartridge system enables rapid change of exhausted cartridges without interrupting supply or system operation. A wide range of individual cartridges or combination cartridges are available to suit a variety of applications.

Ultra-High Capacity Moisture Filter

Moisture in carrier gas lines will prematurely degrade oxygen and hydrocarbon traps and increase detector noise. As a precaution, we highly recommend installing a moisture trap before the hydrocarbon and oxygen traps on all carrier gas lines.



Capacity	
H ₂ O	7.2 g
Description	
Specification	
Outlet Gas Quality (%)	> 99.9999
Maximum Pressure	15 bar (217 psi)
Maximum Flow	7 L/min
Usable For	Inert carrier gas, He, H ₂ , N ₂ , Ar, Air
Dimensions	24 cm x Ø 4.4 cm
Weight	0.26 Kg
Part No.	
N9306814	

Ultra-High Capacity Oxygen Filter

Oxygen is a column killer – it is present even in UHP gases. Because oxygen can enter a gas line at any fitting or during gas bottle exchange, the oxygen trap should be the last connection before the gas line enters the chromatograph.



Capacity	
O ₂	150 mL
Description	
Specification	
Outlet Gas Quality (%)	> 99.9999
Maximum Pressure	15 bar (217 psi)
Maximum Flow	7 L/min
Usable For	Inert carrier gas, He, H ₂ , N ₂ , Ar
Dimensions	24 cm x Ø 4.4 cm
Weight	0.26 Kg
Part No.	
N9306815	

Ultra-High Capacity Hydrocarbon Filter

Use a hydrocarbon trap if your gas has a potential source of hydrocarbon contaminants or if you suspect you are observing carrier gas ghost peaks. Install the hydrocarbon trap after the moisture trap, to prevent moisture from degrading the hydrocarbon-trapping ability of the activated carbon in the hydrocarbon trap.



Capacity	
HC	12 g (as <i>n</i> -butane)
Description	
Specification	
Outlet Gas Quality (%)	> 99.9999
Maximum Pressure	15 bar (217 psi)
Maximum Flow	7 L/min
Usable For	Inert carrier gas, He, H ₂ , N ₂ , Ar, Air
Dimensions	24 cm x Ø 4.4 cm
Weight	0.26 Kg
Part No.	
N9306816	

High Capacity Combi Filter

This filter is perfect for purifying Flame Ionization Detector (FID) fuel gases, removing both moisture and hydrocarbons. Using this filter for FID hydrogen and air will produce a stable baseline, improving overall reproducibility and sensitivity. Ideal for use in combination with a zero air generator.



Capacity	
H ₂ O	3.5 g
HC	6 g (as <i>n</i> -butane)
Description	
Specification	
Outlet Gas Quality (%)	> 99.9999
Maximum Pressure	15 bar (217 psi)
Maximum Flow	7 L/min
Usable For	Inert carrier gas, He, H ₂ , N ₂ , Ar, Air
Dimensions	24 cm x Ø 4.4 cm
Weight	0.26 Kg
Part No.	
N9306818	

High Capacity Triple Filter

The triple trap is ideal for purifying carrier gas. It contains oxygen, moisture and hydrocarbon scrubbers in one easy to change economical cartridge.



Capacity	
H ₂ O	1.8 g
O ₂	75 mL
HC	4 g (as <i>n</i> -butane)
Description	Specification
Outlet Gas Quality (%)	> 99.9999
Maximum Pressure	15 bar (217 psi)
Maximum Flow	7 L/min
Usable For	Inert carrier gas, He, H ₂ , N ₂ , Ar
Dimensions	24 cm x Ø 4.4 cm
Weight	0.26 Kg
Part No.	N9306819

High Capacity Triple Filter Helium Specific

The helium-specific triple trap is ideal for purifying helium in GC/MS systems. This trap is packed and purged under helium and contains oxygen, moisture and hydrocarbon scrubbers in one cartridge.



Capacity	
H ₂ O	1.8 g
O ₂	75 mL
HC	4 g (as <i>n</i> -butane)
Description	Specification
Outlet Gas Quality (%)	> 99.9999
Maximum Pressure	15 bar (217 psi)
Maximum Flow	7 L/min
Usable For	He
Dimensions	24 cm x Ø 4.4 cm
Weight	0.26 Kg
Part No.	N9306820

High Capacity Triple Filter Hydrogen Specific

The hydrogen-specific triple trap is ideal for purifying hydrogen in GC/MS systems. This trap is packed and purged under hydrogen and contains oxygen, moisture and hydrocarbon scrubbers in one cartridge.



Capacity	
H ₂ O	1.8 g
O ₂	75 mL
HC	4 g (as <i>n</i> -butane)
Description	Specification
Outlet Gas Quality (%)	> 99.9999
Maximum Pressure	15 bar (217 psi)
Maximum Flow	7 L/min
Usable For	H ₂
Dimensions	24 cm x Ø 4.4 cm
Weight	0.26 Kg
Part No.	N9306822

Ultra Clean Replacement Individual Cartridge Filters for GC and GC/MS



Description	Qty.	Part No.
Ultra Clean Moisture Filter	1	N9306814
Ultra Clean Oxygen Filter	1	N9306815
Ultra Clean Hydrocarbon Filter	1	N9306816
Ultra Clean Combi (Hydrocarbon/Moisture) Filter	1	N9306818
Ultra Clean Triple (Oxygen/Moisture/Hydrocarbon) Filter	1	N9306819
Ultra Clean Triple (Oxygen/Moisture/Hydrocarbon) Helium-Specific Filter	1	N9306820
Ultra Clean Triple (Oxygen/Moisture/Hydrocarbon) Hydrogen-Specific Filter	1	N9306822

Accessories

Ultra Clean Base Plate Flush Cap Replacement Set for GC/MS



Description	Qty.	Part No.
Ultra Clean Flush Cap Replacement Set	2	N9306852

Wall Mounting Bracket for All Cartridge Base Plates



Description	Qty.	Part No.
Ultra Clean Wall-Mounting Bracket Set	1	N9306855

Replacement O-rings for All Cartridge Base Plates



Description	Qty.	Part No.
Ultra Clean Base Plate O-ring Replacement Set	20	N9306854

Ultra Clean Base Plate Fittings for GC and GC/MS



Description	Qty.	Part No.
Ultra Clean Connector Set – 1/4 in. Brass	6	N9306846
Ultra Clean Connector Set – 1/8 in. Brass	6	N9306847
Ultra Clean Connector Set – 1/4 in. Stainless Steel	6	N9306848
Ultra Clean Connector Set – 1/8 in. Stainless Steel	6	N9306849

Click-On Inline Super Clean Purifiers

Using the Click-On Connectors lets you change the trap without introducing contaminants into your system. Click-On connectors can replace a trap, without introducing impurities into the system. This in turn eliminates the need to flush the system.

The ability to add a Click-On Inline Super Clean™ Indicator after the stainless steel trap gives the user a clear visual indication of when to change the filter. This indicator may also be used as a standalone trap.

Features and Benefits

- Reduce system downtime with Click-On fast connectors
- No open gas line when changing the trap
- Helium Specific Glass Indicating Triple Trap is ideal for GC/MS

Stainless Steel Trap Kits

Description	Connector (Qty.)	Part No.
Combination: Oxygen/Moisture Trap	1/8 in. Brass (2)	N9306108
Combination: Oxygen/Moisture Trap	1/8 in. Stainless Steel (2)	N9306109
Combination: Moisture/Hydrocarbons Trap	1/8 in. Brass (2)	N9306117
Combination: Moisture/Hydrocarbons Trap	1/8 in. Stainless Steel (2)	N9306118
Triple: Oxygen/Moisture/Hydrocarbons Trap	1/8 in. Brass (2)	N9306110
Triple: Oxygen/Moisture/Hydrocarbons Trap	1/8 in. Stainless Steel (2)	N9306111
Triple Gas Specific (He): Oxygen/Moisture/Hydrocarbons	1/8 in. Brass (2)	N9306112
Triple Gas Specific (He): Oxygen/Moisture/Hydrocarbons	1/8 in. Stainless Steel (2)	N9306113

Product Specifications

Purifier Type	Gas Quality*	Max Pressure	Max Flow	Use For	H ₂ O	Capacity O ₂	Hydrocarbons	Est. Lifetime
Moisture	> 99.9999 %	11 bar, 160 psi	25 L/min	Inert carrier gas He, Air, H ₂	21 g	–	–	> 3 years
Oxygen	> 99.9999 %	11 bar, 160 psi	25 L/min	Inert carrier gas	–	3,000 mL	–	> 3 years
Hydrocarbons	> 99.9999 %	11 bar, 160 psi	25 L/min	Inert carrier gas Air, H ₂	–	–	36 g (as <i>n</i> -butane)	> 3 years
Combination Moisture/ Hydrocarbons	> 99.9999 %	11 bar, 160 psi	25 L/min	Inert carrier gas He, Air, H ₂	10 g	–	18 g (as <i>n</i> -butane)	> 2 years
Indicating Triple Moisture/ Oxygen/Hydrocarbons	> 99.9999 %	11 bar, 160 psi	25 L/min	Inert carrier gas He	3 g	400 mL	5 g (as <i>n</i> -butane)	> 1 year
Triple Moisture/ Oxygen/ Hydrocarbons	> 99.9999 %	11 bar, 160 psi	25 L/min	Inert carrier gas	6 g	1,000 mL	12 g (as <i>n</i> -butane)	> 2 years

* Results @ 2 L/min.

Stainless Steel Traps



Description	Part No.
Moisture Trap	N9306100
Oxygen Trap	N9306101
Hydrocarbons Trap	N9306102
Combination: Oxygen/Moisture Trap	N9306103
Combination: Moisture/Hydrocarbons Trap	N9306105
Triple: Oxygen/Moisture/Hydrocarbons Trap	N9306104
Triple Gas Specific (He): Oxygen/Moisture/Hydrocarbons	N9306106

Click-On Connectors

Description	Part No.
Click-On Connector Set – 1/8" Brass (Includes (2) 1/8" Brass Click-On Connectors)	N9306119
Click-On Connector Set – 1/8" SS (Includes (2) 1/8" Stainless Steel Click-On Connectors)	N9306120
Click-On Double Connector Set	N9306121

Helium Specific Glass Indicating Triple Trap for your PerkinElmer Clarus GC/MS

This trap contains oxygen, moisture and hydrocarbons adsorbents in one trap and is packed and purged under helium.

The glass indicating trap clearly shows when the filter needs to be replaced with the use of color changes. The packing material is a silica-based environmentally friendly substitute for cobalt dioxide (blue) in the moisture indicator.

Available as a kit with the necessary 1/8 in. brass connectors, and as a replacement trap. This system is easy to install.

Description	Connector (Qty.)	Part No.
Indicating Glass Triple Gas Specific (He): Oxygen/Moisture/Hydrocarbons	Not Included	N9306107
Indicating Glass Triple Gas Specific (He): Oxygen/Moisture/Hydrocarbons	1/8 in. Brass (2)	N9306114
Indicating Glass Triple Gas Specific (He): Oxygen/Moisture/Hydrocarbons	1/8 in. Stainless Steel (2)	N9306116

Hydrocarbon Trap



Description	Part No.
Hydrocarbon Trap	N9301192

Use our activated charcoal in-line trap to remove gaseous hydrocarbons (C5 and heavier) from nitrogen, hydrogen and inert carrier gas supplies. Recommended for use with purge and trap apparatuses, high-sensitivity FID operations and with GC carrier gases for trace analyzes. Frits in each end prevent particulates from entering the gas stream. Trap is shipped filled with helium. Maximum pressure is 1000 psi (69 bar). Maximum flow rate 10 SLPM, reduces hydrocarbons < 5 ppb at outlet. Dimensions are 5 x 37 cm including fittings. Weight is 1.0 kg.

Indicating Oxygen Trap



Description	Part No.
Indicating Oxygen Trap	N9301191

This high-efficiency indicator trap reduces oxygen to less than 0.1 ppm. Changes color from bright green to gray when adsorption capacity is depleted. Oxygen capacity for this compact unit is 0.05 g at STP. The non-contaminating, heavy-wall inner glass tube of adsorbent is protected from breakage by the outer plastic tube. Maximum pressure is 100 psi (6.9 bar). Maximum flow rate 2 SLPM, reduces oxygen < 5 ppb at outlet. Dimensions are 3.2 x 26 cm including fittings. Weight is 0.2 kg.

Oxygen Trap



Description	Part No.
Oxygen Trap	N9301179

This high-capacity, high-efficiency trap is used for long-term protection of capillary column stationary phases against oxidation at GC operating temperatures. Can remove 3.5 g of oxygen and has an output efficiency of less than 10 ppb oxygen concentration at the outlet. Effective at removing sulfur compounds, such as hydrogen sulfide and mercaptans. Intended for use with non-oxidizing gases such as He, Ar, N₂, H₂ or CH₄, containing less than 1% oxygen. The trap is filled with 500 cc of active oxygen adsorbent that binds covalently with oxygen; no gas is generated from this reaction. Maximum pressure is 1000 psi (69 bar). Maximum flow rate 10 SLPM, reduces moisture < 10 ppb at outlet. Dimensions are 5 x 37 cm including fittings, weight is 1.2 kg.

Safe Glass Moisture Trap



Description	Part No.
Safe Glass Moisture Trap	N9301193

Gas contacts only glass, metal and the adsorbents for purity. The CoFree (cobalt-free) indicator and molecular sieve 5A are packed in glass protected by an outer plastic tube in the event that the glass breaks. Unique loading design allows operation in any orientation without channeling. Designed for GC detectors that require high purity gases and recommended for ELCD and ECD systems where moisture and contamination are a problem. Maximum pressure is 100 psi (6.9 bar). Maximum flow rate 2 SLPM, reduces moisture < 20 ppb at outlet. Dimensions are 3.2 x 26 cm including fittings. Weight is 0.3 kg.

Gas In-line Filter



Description	Part No.
Gas In-line Filter	N9301178

The Gas In-line Filter Trap removes moisture, oil and dust from nitrogen or inert supply gases. It has 400 cc total volume of molecular sieve 5A and an indicator in a clear acrylic tube. The CoFree (cobalt-free) indicator changes color at low relative humidity indicating that the packing must be changed. Base-plate version is available for free-standing orientation. Maximum pressure is 100 psi (6.9 bar). Maximum flow rate 30 SLPM, reduces moisture < 20 ppb at outlet. Dimensions are 6 x 43 cm including fittings. Weight is 1.0 kg.

Cobalt-free Adsorbent Refill Kit



Description	Part No.
Cobalt-free Adsorbent Refill Kit	N9301176

The CoFree gas in-line filter indicator (**N9301178**) will change from greenish-yellow to blue when the purifier begins to deplete. When the depletion process begins, this refill kit should be used to replace the adsorbent and indicator.

NEW PKI-Pure Purifiers

Rated to 1000 psi, PerkinElmer's new range of PKI-Pure Purifiers are designed to reduce contaminants to low ppb levels, with very high capacity in a compact design (130 cc size filter). The filters feature high-quality activated adsorbents for long filter life and efficient contaminant removal.

PKI-Pure HC Purifier



Description	Part No.
PKI-Pure HC Purifier	N9303967

This in-line purifier removes hydrocarbons (C5 and heavier) from inert gases, clean dry air, and hydrogen to low ppb-levels (< 5 ppb) to improve baseline noise and sensitivity. The stainless steel body has all metal seals to create an ultra-high vacuum seal, reducing the chance of leaks. Frits in each end prevent particulates from entering the gas stream. Maximum pressure is 1000 psi. Maximum flow rate 10 SLPM, reduces hydrocarbons < 5 ppb at outlet. Available in a 130 cc size cylinder. Dimensions are 3.2 x 28 cm including fittings (1/8 in. brass standard compression fittings). Weight is 0.7 kg. Shipped filled with helium.

PKI-Pure H₂O Purifier



Description	Part No.
PKI-Pure H ₂ O Purifier	N9303965

This in-line purifier removes moisture from inert gases, clean dry air, and hydrogen to less than 20 ppb-levels. The stainless steel body has all metal seals to create an ultra-high vacuum seal, reducing the chance of leaks. Frits in each end prevent particulates from entering the gas stream. Maximum pressure is 1000 psi. Maximum flow rate 10 SLPM, reduces moisture < 20 ppb at outlet. Available in a 130 cc size cylinder. Dimensions are 3.2 x 28 cm including fittings (1/8 in. brass standard compression fittings). Weight is 0.7 kg. Shipped filled with helium.

PKI-Pure O₂ Purifier



Description	Part No.
PKI-Pure O ₂ Purifier	N9303966

This in-line purifier removes oxygen from GC carrier gases to low ppb-levels (< 5 ppb) to protect the column's stationary phase from oxygen degradation. The stainless steel body has all metal seals to create an ultra-high vacuum seal, reducing the chance of leaks. Frits in each end prevent particulates from entering the gas stream. Maximum pressure is 1000 psi. Maximum flow rate 1 SLPM, reduces oxygen < 5 ppb at outlet. Available in a cc size cylinder. Dimensions are 3.2 x 28 cm including fittings (1/8 in. brass standard compression fittings). Weight is 0.7 kg. Shipped filled with helium.

GC Startup Kits

Description	Part No.
GC Startup Kit 1/8 in. Tubing and Fitting for (3) Gases	N9306304

Description	Qty.
1/8 in. Tubing x 50 ft Coil Copper Special Cleaning	1
1/8 in. Compression Brass Tee Two Piece Ferrule Brass	3
Tee 1/8 in. Com x 1/8 in. Comp x 1/4 in. fnpt Brass	3
Adjustable Safety Relief Valve Brass 50 – 150 psi	3
1/4 in. fnpt x 1/8 in. Comp Fitting Brass	3
1/8 in. Port Connector Brass	3
1/8 in. Ferrule Brass	3
1/8 in. Compression Brass Nut	3
1/8 in. Compression Brass Fitting Cap	3
Tubing Cutter 1/8 in. Tubing	1
PTFE Tape	1

Description	Part No.
GC Startup Kit 1/8 in. Tubing and Fitting With One Dual Stage Regulator	N9306306

Description	Qty.
1/8 in. Tubing x 50 ft Coil Copper Special Cleaning	1
1/8 in. Compression Brass Tee Two Piece Ferrule Brass	3
Tee 1/8 in. Com x 1/8 in. Comp x 1/4 in. fnpt Brass	3
50 – 150 psi	3
1/4 in. fnpt x 1/8 in. Comp Fitting Brass	3
1/8 in. Port Connector Brass	3
1/8 in. Ferrule Brass	3
1/8 in. Compression Brass Nut	3
1/8 in. Compression Brass Fitting Cap	3
Tubing Cutter 1/8 in. Tubing	1
PTFE Tape	1
Dual Stage Analytical 0 – 100 psig delivery, CGA 580 (N ₂ , Argon, He)	1

Basic Tool Kit

Kit Includes: Open-end Wrench Set (6 pc), Screwdriver Set (6 pc.), Adjustable Wrench (6 in.), Chain Nose Pliers (narrow), Wire Cutters, and Wire Strippers.

Description	Part No.
Tools come in a tool box for easy storage and use	N9301327

Deluxe Tool Kit

Kit Includes: Open-end Wrench Set (6 pc.), Screwdriver Set (6 pc.), Adjustable Wrench (6 in.), Chain Nose Pliers (narrow), Wire Cutters, Wire Strippers, Slip-joint Pliers (6 in.), Long Nose No. 5 Stainless Steel Tweezers (4-3/8 inches), Needle File Set (6 pc.), Allen Key Set (11 pc. imperial sizes), and Allen Key Set (9 pc. metric sizes).

Description	Part No.
Shipped in a plastic tool box for convenient storage	N9301328

Regulators

Pressure Regulators

Ideally suited for chromatographic carrier gas applications including FID, TCD, ECD, HID, and non-corrosive gas mixtures for analytical instrumentation.



Technical Specifications

Specifications	Single Stage – Stainless Steel (Thread-less Seat) Part No. N9306353	Single Stage – Brass Nickel-plated (Thread-less Seat) Part No. N9306354
Max Rated Inlet Pressure	1,250 psig	1,200 psig
Outlet Pressure Ranges	0– 30, 0– 60, 0– 100, 0– 250 psig	0– 25, 0– 50, 0– 100, 0– 250 psig
Flow Capacity	Cv=0.066	Cv=0.15
Ambient Operating Temp	-40° F to +165° F	-40° F to +165° F
Designed Leak Rate	2 x10-8 ccs (helium)	Bubble-tight (helium)
Weight	2 lbs	2.4 lbs
Ports (4)	¼ in. FNPT	¼ in. FNPT
Fittings	1/8 in.	1/8 in.
Inlet	1/8 in. FNPT	1/8 in. FNPT
Outlet	1/8 in. FNPT	1/8 in. FNPT
Decay Inlet Characteristic	–	0.23/100 psi
Materials		
Body	316 Stainless Steel	Nickel-Plated Brass
Bonnet	Nickel Plated Brass	Nickel Plated Brass
Seat	PCTFE®	PTFE
Diaphragm	Hastelloy C-22	316 Stainless Steel
Diaphragm Hastelloy C-22 Gauge	2½ in. Stainless Steel	–
Filter	316 Stainless Steel	316 Stainless Steel
Trim	316 Stainless Steel	Nickel Plated Brass
Gauges	–	2½ in. Stainless Steel
Valve Stem	–	316 Stainless Steel
Valve Spring	–	316 Stainless Steel

High Purity Brass Regulators

PerkinElmer regulators are constructed of high purity brass barstock and have stainless steel diaphragms and metal-to-metal seals. They are suitable for use with high purity (>99.995% pure) non-corrosive gases. Regulators terminate in a 1/4 in. NPT Swagelock fitting.



Features and Benefits

- Barstock body construction
- Stainless steel diaphragms
- Metal-to-metal seals
- Use with high purity carrier gas

High Purity Brass Regulators (Dual Stage)

CGA Fitting	Delivery Pressure Use	Delivery Pressure Range (psig)	Cylinder Pressure Gauge (psig)	Gauge (psig)	Part No.
CGA-350	H ₂ and Ar/CH ₄	4 – 100	0 – 200	0 – 4,000	09907128
CGA-580	He, Ar, N ₂	4 – 100	0 – 200	0 – 3,000	09907127

High Purity Brass Regulators (Single Stage)

CGA Fitting	Delivery Pressure Use	Delivery Pressure Range (psig)	Cylinder Pressure Gauge (psig)	Gauge (psig)	Part No.
CGA-350	CO, H ₂ and Ar/CH ₄ Mixes	4 – 100	0 – 150	0 – 4,000	00230091
CGA-350	CO, H ₂	10 – 200	0 – 400	0 – 4,000	00230253
CGA-590*	Air	10 – 200	0 – 400	0 – 4,000	00230090

*Supplied with 590-580 Adapter.

Portable Gas Leak Detector

The compact handheld electronic gas leak detector is the ideal solution for detecting gas leaks in your GC systems. Leaks in your system waste gas and can cause detector noise, baseline instability, and shorter column life. This portable unit detects minute leaks of any gas with thermal conductivity different from air. The reference gas inlet draws in ambient air for comparison to air drawn into the sample probe. A leak is detected by both LED bar graph display and audible alarm.



Features and Benefits

- Sleek ergonomic, hand-held design with rugged side grips
- Automatic shut-off capabilities
- Optimized sample flow path
- LED readout and audible alarm

Detectable Gases

Gas Type	Minimum Detectable Leak Rate (atm cc/sec)	Indicating LED Light Color
Helium	1.0×10^{-5}	Red
Hydrogen*	1.0×10^{-5}	Red
Nitrogen	1.4×10^{-3}	Yellow
Argon	1.0×10^{-4}	Yellow
Carbon Dioxide	1.0×10^{-4}	Yellow

Description	Specification
Battery	Rechargeable Ni-MH internal battery pack (6 hours normal operation)
Universal Power Adapter Set	US, UK, European, Australian plugs included
Temperature Range	32 – 120 °F (0 – 48 °C)
Humidity Range	0 – 97%
Warranty	1 Year
Certifications	CE (EU, Korea, Japan, Australia); UKCA
Compliance	WEEE, CEC, China RoHS 2

Description	Part No.
Portable Electronic Leak Detector	N9306371
Soft Carrying Case	N9306142
Probe (Fine Tip)	N9306063

* Caution: The PerkinElmer leak detector is not designed for determining leaks in a combustible environment. This unit may be used for determining trace amounts of hydrogen in a GC environment only.



MiniTemp MT4 Non-contact Temperature Measurement with Laser Sighting

Features and Benefits

- Displays thermal measurement readings in °C or °F
- Easy point and shot infrared technology in a pocket size configuration
- Great for instrument thermal test confirmation, including GC injector port and detector measurements, thermostatted LC vials, and enzymatic hydrolysis baths



MiniTemp MT4 Technical Specifications

Description	Specification
Temperature Range	-18 to 400 °C (0 to 750 °F)
Distance to Spot Size (D:S)	08:01
Response Time	500 m/sec
Emissivity	Pre-set at 0.95
Accuracy	±2%, or ±2 °C (±3 °F) whichever is greater
Typical Distance to Target (Spot)	Up to 1.5 m (4 ft)
Laser Sighting	Yes

The popular MiniTemp MT4 also includes single dot laser sighting to assist with aiming. 9 volt battery included. Recalibration is not available.

Description	Part No.
MiniTemp MT4	N9306074

PerkinElmer FlowMark Electronic Flowmeter



PerkinElmer's FlowMark™ flowmeter is specifically designed for use with gas chromatography (GC) instruments. The probe is applied directly to the gas flow stream and the measured flow rate is presented on the LCD screen.

Units of flow are measured in mL/min. This unit provides continuous real-time measurements of gas streams ranging from 0.50 mL/min to 500 mL/min. Because the technology uses volumetric flow measurement, the unit is compatible with all laboratory gases. The flowmeter is designed to measure clean, dry, non-corrosive gases.

Features and Benefits

- Measures volumetric flow for all gases across a range of 0.5–500 mL/min
- NIST traceable calibration
- Explosion-proof rating for flammable and explosive gas atmospheres
- Accuracy of $\pm 2\%$ of flow or ± 0.2 mL/min, whichever is greater
- Over range indicator
- Auto shut-off feature
- Ergonomic design and side grips for comfort
- Measures most gas types
- Convenient storage case included
- CE, Ex (Compliance: WEEE, RoHS) certified
- Uses 2-AA batteries
- Data output via USB port
- Re-calibration service available
- Designed to measure clean, dry, non-corrosive gases
- 1 year warranty

Description	Part No.
FlowMark Electronic Flowmeter	N9307086
Recalibration Service for FlowMark Flowmeter	N9307085
Soft Carrying Case	N9306142

PerkinElmer Flowmeter Plus



The PerkinElmer Flowmeter Plus is a valuable tool for troubleshooting detector problems. Measuring gas volumetrically eliminates the need to select gas type.

Hassle Free Recalibration

Offering a much simpler and more efficient work flow, the annual recalibration is simply replacing a NIST certified calibration cartridge. Each flowmeter cartridge is individually factory calibrated and can easily be replaced directly by customers.

There is no need to return the flowmeter to us; saving you time and money.

The cartridge calibration is valid for a period of one year from its first use. A new, calibrated cartridge can be ordered in advance, and then installed when necessary.

Features and Benefits

- Simply replace a NIST certified cartridge for revalidation, no need to return the flowmeter
- Flow range 0.5 to 750 mL/min (auto-ranging)
- Operating temperature range 0 °C to 45 °C
- Accurate to $\pm 2\%$ of reading or ± 0.2 mL/min, whichever is greater
- Compact size (201 mm x 88 mm x 48 mm)
- Portable operation, uses 3 AA batteries (or USB power)

Description	Part No.
Flowmeter Plus	N9307088
Replacement NIST Certified Calibration Cartridge	N9307084

Standards

PerkinElmer offers a wide selection of superior quality products designed to work with your PerkinElmer instruments. Our precision designed products deliver the peace of mind that comes from knowing that you'll get the results you need.

Quick Reference Index

	Page
▶ ASTM D2887	169
▶ ASTM D3606	168
▶ ASTM D4815	168
▶ ASTM D5580	168
▶ ASTM D5623	169
▶ ASTM D5134, D6296, D6729, D6730, and D6733	170
▶ ASTM D7213	169
▶ ASTM D7423, D7754, UOP 960	168
▶ Method 624	167
▶ Method 625	167
▶ Method 8082	167
▶ Method 8100	167
▶ Method 8260B	166
▶ Method 8270C	167
▶ Reference Gas Oil 5010	169
▶ Simulated Distillation Reference Material	169
▶ Standards Solutions	166
▶ Volatile Organics Combination Blend	166

ASTM Reference Standards

We offer a selection of ASTM reference standards to assist you with all your Arnel application needs in hydrocarbon-processing industries, with focuses on custom-engineered solutions for gas chromatography applications in the petrochemical, food and beverage, and industrial hygiene markets.



▶ [VIEW PAGE](#)

Organic Certified Reference Materials

We offer a wide selection of GC and GC/MS standards. Each solution is supplied with a comprehensive Certificate of Analysis that documents quality and assurance to the highest level obtainable by a Calibration Standard. Organic Certified Reference Materials from PerkinElmer are a new addition to an already extensive organic product line designed to enhance your one-stop shopping experience.



▶ [VIEW PAGE](#)

Standard Solutions

This section will cover HPLC performance test mixes to monitor column performance over time, and a series of polycyclic aromatic hydrocarbon (PAH) standards.

▶ [VIEW PAGE](#)

Standards Solutions

We offer HPLC performance test mixes to monitor column performance over time, and a series of polycyclic aromatic hydrocarbon (PAH) standards.

Description	Part No.
Test Mix	
LC Gradient Test Mix	N9334010
Universal Test Mix for Reversed-phase (5 mL/pkg.)	00890893
Standards	
HPLC SV Calibration Mix No.5/610 PAH	00891542
HPLC 610 Calibration Mix A	00891543
HPLC 610 Calibration Mix B	00891544

Organic Certified Reference Materials

PerkinElmer offers a wide selection of GC and GC/MS standards. Each solution is supplied with a comprehensive Certificate of Analysis that documents quality and assurance to the highest level obtainable by a Calibration Standard.

Organic Certified Reference Materials from PerkinElmer are a new addition to an already extensive organic product line designed to enhance your one-stop shopping experience. Each new standard is provided in convenient 1.2 mL ampules to minimize waste and comes with a pre-labeled amber glass storage vial with cap for easy use.



To ensure customer satisfaction, our Organic Mixes are prepared at concentration levels that take into consideration a number of factors including: vapor pressure, evaporation, breakdown rates and dilution schemes. PerkinElmer goes the extra step by analyzing each organic standard on the Clarus 600 GC and GC/MS state-of-the-art instrumentation to ensure that the standard conforms to the customer's exact needs.

For customer ease, all Organic Standards are prepared with a precision of +/- 0.5% and accompanied with a comprehensive Certificate of Analysis (lot specified by part number). Data packs are also available upon request. These include a chromatogram of the standard and quantitative report listing the values for each analyte.

Method 8260B for Water and Solid Waste Matrices

Method 8260B is an analytical method that uses a GC/MS equipped with a capillary column to perform the separation of the volatile organic compounds found in water and a variety of solid waste matrices.

Method 524.2 is an analytical method that uses a purge and trap device for sample preparation and a GC/MS equipped with a capillary column to perform the separation of volatile organic compounds.

Volatile Organics Combination Blend

Contains all analytes in Mixes A, C and D.

Method SW-846 is an analytical method which utilizes a Clarus 600 GC to perform the separation of the volatile organic components found in a variety of solid waste matrices. To detect the GC eluant a Clarus 600 GC/MS is used.

Description	Part No.
1.2 mL @ 2,000 µg/mL in P and T Methanol	N9331047

Method 8260B Standards

Description	Part No.
Alternate Four-Component Surrogate Standard for Method 8260B 1.2 mL @ 2,000 µg/mL in P and T Methanol	N9331042
Internal Standard for Method 8260B 1.2 mL @ 2,000 µg/mL in P and T Methanol	N9331041

Ketones for Method 8260B

Description	Part No.
1.2 mL @ 2,000 µg/mL in P and T Methanol	N9331043

Mix B Purgeable Gases for Methods 8260B/524.2

Description	Part No.
1.2 mL @ 2,000 µg/mL in P and T Methanol	N9331048

8000 Series Solid and Hazardous Waste Methods

Resource Conservation and Recover Act (RCRA) Under SW-846, 'Test Methods For Evaluating Solid Waste'

Features and Benefits

- Method 8080A contains detailed operating procedures to be followed by laboratories analyzing solid and liquid matrices. It is a method that uses a GC/ECD to perform the separation of the selected pesticides following concentration and clean up of an extract for aqueous or solid samples
- Method 8082 is used to determine the concentrations of PCBs, either as individual congeners or Aroclors by GC/ECD

Method 8082 PCBs (polychlorinated biphenyls) Standards Kit

Method 8082 is used to determine the concentration of PCBs either as individual congeners or Aroclors. A Clarus 600 GC with a capillary column is used to perform the separation. To detect the eluent, an ECD (electron capture detector) or ELCD (electrolytic conductivity detector) is used.

Description	Part No.
1.2 mL @ 1,000 µg/mL in Hexane	N9331028

Method 8270C Standards

Method 8270C is an analytical method which utilizes a Methylene Chloride extraction of aqueous sample or Methylene Chloride: Acetone extraction of solid sample and a Clarus 600 GC equipped with a capillary column to perform the separation of the compounds. To detect the GC eluant a Clarus 600 GC/MS is used.

Description	Part No.
Semi-Volatile Calibration Standard for Method 8270C 1.2 mL @ 1,000 µg/mL in Hexane	N9331030
Internal Standard for Method 8270C 1.2 mL @ 2,000 µg/mL in Methylene Chloride/Benzene	N9331036

Method 8270C Mixes

Description	Part No.
HICAL-Acids Mix for Method 8270C 1.2 mL @ 2,000 µg/mL in Methylene Chloride	N9331031
Analyte Mix for Method 8270C 1.2 mL @ 2,000 µg/mL in Methanol	N9331032
Balance Mix for Method 8270C 1.2 mL @ 2,000 µg/mL in Methylene Chloride	N9331033

Method 8270C Surrogates

Description	Part No.
Acid Surrogate for Method 8270C 1.2 mL @ 2,000 µg/mL in Methanol	N9331037
Base Neutral Surrogate for Method 8270C 1.2 mL @ 2,000 µg/mL in Methylene Chloride/Acetone	N9331038

600 Series Wastewater Methods Clean Water Act 'Wastewaters'

Method 624 Standards Kit for Volatile Organic Compounds

Contains: **N9331060, N9331061, N9331062, N9331063.**

The U.S. EPA Method 624 is an analytical method which utilizes a TurboMatrix Headspace Purge and Trap instrument for sample prep and a Clarus 600 GC equipped with a packed column to perform the separation of the volatile organic compounds found in a 5 mL sample of municipal or industrial wastewater. To detect the eluant a Clarus 60 GC/MS is used.

Description	Part No.
1.2 mL @ 2,000 µg/mL in P and T Methanol	N9331064
Mix A for Method 624 1.2 mL @ 2,000 µg/mL in P and T Methanol	N9331060
Purgeable Gases Mix B for Method 624 1.2 mL @ 2,000 µg/mL in P and T Methanol	N9331061
Mix C for Method 624 1.2 mL @ 2,000 µg/mL in P and T Methanol	N9331062
Mix D for Method 624 1.2 mL @ 2,000 µg/mL in P and T Methanol	N9331063

Method 8100

Method 8100 is a method for the analysis of polynuclear aromatic hydrocarbons. A Clarus 600 GC is used to perform the separation of compounds with an FID (flame ionization detector) to detect the eluent.

Method 625

Method 625 is an analytical method that uses a methylene chloride extraction of municipal or industrial wastewater, concentrated to 1 mL and a GC/MS equipped to perform the separation of acid and base neutral extractable fractions.

Description	Part No.
Polynuclear Aromatic Hydrocarbons for Method 8100/625 1.2 mL @ 2,000 µg/mL in Methylene Chloride/Benzene	N9331044
Polynuclear Aromatic Hydrocarbons Mix B for Method 8100 1.2 mL @ 1,000 µg/mL in Methylene Chloride/Benzene	N9331045
Surrogate Standard for Method 8100 1.2 mL @ 2,000 µg/mL in Methylene Chloride	N9331046

For Gasoline and SIMDIS Analysis

Today's analytical laboratories need more than high quality, reliable instrumentation, and information. They need complete systems and guaranteed solutions that meet industry standards and specifications. PerkinElmer offers a selection of ASTM Reference Standards to assist you with all your Arnel application needs in hydrocarbon-processing Industries with focuses on custom-engineered solutions for gas chromatography applications in the petrochemical, food, and beverage, and industrial hygiene markets. Our goal is to develop cleaner, petroleum-based products to help reduce their impact on the environment as well as assist in manufacturing more cost-effective petroleum products.

ASTM D7423, D7754, UOP 960

Standard Test Method for Determination of Oxygenates in C2, C3, C4, and C5 Hydrocarbon Matrices by Gas Chromatography and Flame Ionization Detection.

Description	Volume	Part No.
ASTM D7423 Oxygenates Calibration Kit and Check Standard	5 x 2 mL/1 x 2 mL	N9300285
Components		
acetaldehyde	isobutyl alcohol	
acetone	isobutyraldehyde	
allyl alcohol	isopropyl alcohol	
<i>tert</i> -amyl methyl ether	isopropyl ether	
1-butanol	isovaleraldehyde	
2-butanol	methanol	
2-butanone	2-methyl-2-propanol	
<i>tert</i> -butyl ethyl ether	methyl <i>tert</i> -butyl ether	
butyraldehyde	1-propanol	
dimethyl ether	propionaldehyde	
ethanol	propyl ether	
ethyl ether	valeraldehyde	

ASTM D5580

Standard Test Method for Determination of Benzene, Toluene, Ethylbenzene, p/m-Xylene, o-Xylene, C9 and Heavier Aromatics, and Total Aromatics in Finished Gasoline by Gas Chromatography.

Description	Volume	Part No.
ASTM D5580 Calibration Kit and Valve Timing Solution with ISTD	1 x 10 mL/5 x 1 mL	N9300286
Components		
isooctane	ethylbenzene	
benzene	o-xylene	
toluene	1,2,4-trimethylbenzene	
2-hexanone		



ASTM D3606

Standard Test Method for Determination of Benzene and Toluene in Spark Ignition Fuels by Gas Chromatography.

Description	Volume	Part No.
ASTM D3606 Benzene in Gasoline Calibration Kit and Check Standard	7 x 2 mL/1 x 1 mL	N9300287
Components		
2-butanol	isooctane	
benzene	nonane	
toluene		

ASTM D4815

Standard Test Method for Determination of MTBE, ETBE, TAME, DIPE, tertiary-Amyl Alcohol and C1 to C4 Alcohols in Gasoline by Gas Chromatography.

Description	Volume	Part No.
ASTM D4815 Oxygenates in Gasoline Calibration Kit and Retention Time Mixture	11 x 2 mL/1 x 1 mL	N9300289
Components		
1,2-dimethoxyethane	isopropyl ether	
1-butanol	methanol	
1-propanol	methyl <i>tert</i> -butyl ether	
2-butanol	oxygenate free gasoline, premium	
2-methyl-2-propanol	<i>tert</i> -amyl alcohol	
ethanol	<i>tert</i> -amyl methyl ether	
isobutyl alcohol	<i>tert</i> -butyl ethyl ether	
isopropyl alcohol		

**ASTM D7213**

Description	Volume	Part No.
Simulated Distillation Reference Material Required for ASTM D7213 Extended D2887	1 mL	N9300287
Components		
Polywax 655		

Simulated Distillation Reference Material

Description	Volume	Part No.
Simulated Distillation Reference Material for C5-C120	1 mL	N9308794
Components		
Polywax 1000		

Reference Gas Oil 5010

Description	Volume	Part No.
Reference Gas Oil 5010	5 x 2 mL	N9308755
Components		
1% in carbon disulfide		

ASTM D2887

Standard Test Method for Boiling Range Distribution of Petroleum Fractions by Gas Chromatography.

Description	Volume	Part No.
Reference Gas Oil No. 2 for ASTM D2887	10 x 1 mL	N9308795
Components		
Gasoline		

Description	Volume	Part No.
Custom ASTM D2887 Calibration Mix 1 Wt% in Carbon Disulfide	1 mL	N9308799
Components		
n-decane (C10)	octacosane (C28)	
dotriacontane (C32)	n-octadecane (C18)	
n-eicosane (C20)	octane (C8)	
heptane (C7)	n-pentadecane (C15)	
n-hexane (C6)	n-pentane (C5)	
hexatriacontane (C36)	tetracontane (C40)	
n-dodecane (C12)	n-tetracosane (C24)	
n-heptadecane (C17)	n-tetradecane (C14)	
n-hexadecane (C16)	tetratetracontane (C44)	
nonane (C9)	n-undecane (C11)	

ASTM D5623

Standard Test Method for Sulfur Compounds in Light Petroleum Liquids by Gas Chromatography and Sulfur Selective Detection.

Description	Volume	Part No.
Sulfur Standard for ASTM D5623: Multi-component Standard Containing 22 Sulfur Species at 50 µg/g (as Component) in Base Fuel	2 x 2 mL	N9308796
Components		
2-methyl-1-propanethiol	1-heptanethiol	
2-methylthiophene	1,4-butanedithiol	
3-methylthiophene	methyl ethyl sulfide	
1,2-ethanedithiol	propyl disulfide	
1-pentanethiol	benzothiophene	
2-ethylthiophene	1-hexanethiol	
propyl sulfide	carbon disulfide	
1,5-pentanedithiol	methyl sulfide	
1-nonanethiol	2,2,4-trimethylpentane	
1-decanethiol	n-hexane	
1-propanethiol	toluene	
t-butyl sulfide		

ASTM D5134, D6296, D6729, D6730, and D6733

- Standard Test Method for Detailed Analysis of Petroleum Naphthas through n-Nonane by Capillary Gas Chromatography (D5134).
- Standard Test Method for Total Olefins in Spark-ignition Engine Fuels by Multidimensional Gas Chromatography (D6296).
- Standard Test Method for Determination of Individual Components in Spark Ignition Engine Fuels by 100-Metre Capillary (with Precolumn) High-Resolution Gas Chromatography (D6730).
- Standard Test Method for Determination of Individual Components in Spark Ignition Engine Fuels by 50-Metre Capillary High Resolution Gas Chromatography (D6733).

Description	Volume	Part No.
PIANO (DHA) Standard Detailed Hydrocarbon Analysis ASTM Methods D5134, D6296, D6729, D6730, and D6733	10 x 1 mL	N9308798
Components		
n-butane	2,4-dimethylpentane	4-methyl-1-pentene
n-decane	3,3-dimethylpentane	1-nonene
n-dodecane	2,2-dimethylpropane	<i>trans</i> -2-nonene
n-heptane	3-ethylhexane	<i>cis</i> -3-nonene
n-hexane	3-ethyloctane	<i>trans</i> -3-nonene
n-nonane	3-ethylpentane	<i>cis</i> -4-nonene
n-octane	isobutane	1-octene
n-pentadecane	isopentane	<i>cis</i> -2-octene
n-pentane	2-methylheptane	<i>trans</i> -2-octene
propane	3-methylheptane	1,4-pentadiene
n-tetradecane	4-methylheptane	1-pentene
n-tridecane	2-methylhexane	<i>cis</i> -2-pentene
n-undecane	3-methylhexane	<i>trans</i> -2-pentene
2,2,4-trimethylpentane	2-methylnonane	n-butylcyclopentane
2-methylheptane	3-methylnonane	cyclohexane
2,4-dimethylhexane	2-methyloctane	cyclopentane
2,2-dimethylhexane	3-methyloctane	<i>cis</i> -1,2-dimethylcyclohexane
4-methylheptane	2-methylpentane	<i>trans</i> -1,2-dimethylcyclohexane
2-methyloctane	2,2,3-trimethylbutane	1 <i>c</i> ,3-dimethylcyclohexane
2-methyldecane	2,2,3-trimethylhexane	1 <i>c</i> ,4-dimethylcyclohexane
2,2-dimethyldecane	2,2,4-trimethylhexane	<i>trans</i> -1,4-dimethylcyclohexane
3,3-diethylpentane	2,2,3-trimethylpentane	1,1-dimethylcyclopentane
2,2-dimethylbutane	1-decene	<i>trans</i> -1,2-dimethylcyclopentane
2,3-dimethylbutane	1-heptene	<i>cis</i> -1,3-dimethylcyclopentane
2,2-dimethylheptane	<i>cis</i> -2-heptene	<i>trans</i> -1,3-dimethylcyclopentane
2,3-dimethylheptane	<i>trans</i> -2-heptene	ethylcyclopentane
2,4-dimethylheptane	<i>cis</i> -3-heptene	1-ethyl-1-methylcyclopentane
2,5-dimethylheptane	<i>trans</i> -3-heptene	1- <i>trans</i> -2-ethylmethylcyclopentane
3,3-dimethylheptane	1-hexene	isobutylcyclohexane
3,4-dimethylheptane	<i>cis</i> -2-hexene	isobutylcyclopentane
3,5-dimethylheptane	<i>trans</i> -2-hexene	isopropylcyclopentane
2,2-dimethylhexane	<i>cis</i> -hexene-3	methylcyclohexane
2,3-dimethylhexane	<i>trans</i> -hexene-3	methylcyclopentane
2,4-dimethylhexane	2-methyl-1,3-butadiene	n-propylcyclopentane
2,5-dimethylhexane	2-methyl-1-butene	1,1,2-trimethylcyclohexane
2,2-dimethyloctane	3-methyl-1-butene	1,1,4-trimethylcyclohexane
2,5-dimethyloctane	2-methyl-1-nonene	1,1,2-trimethylcyclopentane
3,3-dimethyloctane	2-methyl-2-pentene	1,1,3-trimethylcyclopentane
2,2-dimethylpentane	3-methyl-t-pentene-2	benzene
2,3-dimethylpentane		n-butylbenzene
		<i>sec</i> -butylbenzene
		<i>tert</i> -butylbenzene
		1,4-diethylbenzene
		1,2-dimethyl-3-ethylbenzene
		1,2-dimethyl-4-ethylbenzene
		1,3-dimethyl-2-ethylbenzene
		1,3-dimethyl-5-ethylbenzene
		1,4-dimethyl-2-ethylbenzene
		ethylbenzene
		hexylbenzene
		isobutylbenzene
		isopropylbenzene
		1,2-di-isopropylbenzene
		2-methylbutylbenzene
		1-methyl-2-ethylbenzene
		1-methyl-3-ethylbenzene
		1-methyl-4-ethylbenzene
		1-methyl-2-isopropylbenzene
		1-methyl-3-isopropylbenzene
		1-methyl-4-isopropylbenzene
		pentylbenzene
		n-propylbenzene
		1,2,4,5-tetramethylbenzene
		toluene
		1,2,4-triethylbenzene
		1,3,5-triethylbenzene
		1,2,4-trimethylbenzene
		1,3,5-trimethylbenzene
		m-xylene
		o-xylene
		p-xylene
		<i>tert</i> -butanol
		ethanol
		isopropanol
		methanol
		methyl decanoate
		MTBE
		TAME

PerkinElmer U.S. LLC
710 Bridgeport Avenue
Shelton, CT 06484 USA
+1 855 726 9377
www.perkinelmer.com



For a complete listing of our global offices, visit www.perkinelmer.com/ContactUs

Copyright ©2023 PerkinElmer U.S. LLC. All rights reserved. PerkinElmer is a trademark of PerkinElmer U.S. LLC. All other trademarks are the property of their respective owners.

500707 (204316) 09-23